



**NORTHLAND
POWER**

Martin's Meadows Solar Project

Design and Operations Report

October 18, 2012



Northland Power Inc.
on behalf of
Northland Power Solar
Martin's Meadows L.P.
Toronto, Ontario

Design and
Operations Report

Martin's Meadows Solar Project

H334844-0000-07-124-0329

Rev. 1

October 18, 2012

Disclaimer

This report has been prepared by or on behalf of Northland Power Inc. for submission to the Ontario Ministry of the Environment as part of the Renewable Energy Approval process. The content of this report is not intended for the use of, nor is it intended to be relied upon by, any other person. Neither Northland Power Inc. nor any of its directors, officers, employees, agents or consultants has any liability whatsoever for any loss, damage or injury suffered by any third party arising out of, or in connection with, their use of this report.

Project Report

October 18, 2012

**Northland Power Inc.
Martin's Meadows Solar Project**

Design and Operations Report

Table of Contents

1. Introduction	5
1.1 Background.....	5
1.2 Objective and Scope.....	5
2. Site Plan	6
3. Facility Design Plan.....	6
3.1 Site Constraints/Regulations	6
3.2 Facility Components	7
3.2.1 Civil Components	7
3.2.1.1 Security Gate, Fencing and Lighting	7
3.2.1.2 Access Roads and Internal Road System	7
3.2.1.3 Drainage System.....	7
3.2.1.4 Foundations.....	7
3.2.1.5 Trenches for Electrical Cables	8
3.2.1.6 Structural Support for PV Modules.....	8
3.2.1.7 Temporary Construction Staging Area.....	8
3.2.1.8 Maintenance Building	8
3.2.2 Electrical Equipment.....	8
3.2.2.1 Modules	8
3.2.2.2 Inverter.....	9
3.2.2.3 Intermediate Transformers	9
3.2.2.4 Medium Voltage Switchgear.....	9
3.2.2.5 Service Equipment.....	9
3.2.2.6 Electrical System.....	9
3.2.2.7 Transformer Substation on Martin's Meadows Solar Project Location.....	10
3.2.2.8 Transformer Substation Electrical Building.....	10
3.2.2.9 115kV Transmission Line.....	10
3.2.2.10 Connection/Switching Station.....	12
3.2.3 Stormwater Management/Erosion and Sediment Control	12
3.2.4 Water Supply and Sanitary System	12
4. Facility Operation Plan	12
4.1 Operations.....	12
4.2 Maintenance.....	12

5. Environmental Effects Monitoring Plan	13
5.1 115-kV Transmission Line Health Effects	14
6. Emergency Response and Communications Plan.....	21
6.1 Emergency Response.....	21
6.1.1 Fire.....	21
6.1.2 Personal Injury	21
6.1.3 Spills	22
6.2 Communications Plan for Non-Emergencies.....	23
7. References.....	23
Appendix A Preliminary Layout	
Appendix B Technical Specifications	

List of Tables

Table 5.1	Summary of Potential Negative Environmental Effects and Proposed Mitigation Occurring During Operations Phase.....	17
Table 5.2	Environmental Effects Monitoring Plan – Design and Operations	19

Blank back

1. Introduction

1.1 Background

Northland Power Solar Martin Meadows L.P. (hereinafter referred to as “Northland”) is proposing to develop a 10-megawatt (MW) solar photovoltaic project titled Martin Meadows Solar Project (hereinafter referred to as the “Project”). The Project is located on Glackmeyer Concession Road 9, in the town of Cochrane (Figure 1.1).

The proposed Project will use solar photovoltaic technology to generate electricity. The solar modules will be mounted on fixed steel supports and arranged in the form seven “power or invert blocks”. Each inverter block will have two inverters rated at 0.714 MW AC and one transformer. Northland will continue to consider mounting solar modules onto a solar tracking support system, however this report has been prepared assuming a fixed steel support structure with modules at a fixed tilt will be used. Electricity generated by solar photovoltaic modules from the solar arrays will be converted from direct current (DC) to alternating current (AC) by an inverter, and subsequently stepped up from a medium voltage to 115 kV, in order to connect to the Hydro One transmission system. The Project will be connected to the provincial grid via a 21-km long 115-kV transmission line along Concession 8 and 9 to a switching station located immediately west of the existing Hydro One 115-kV line north of the community of Hunta, Ontario. Construction of the Project will commence once the Renewable Energy Approval (REA) from the Ministry of the Environment (MOE), and any other required permits and approvals (such as the Ontario Energy Board “Leave to Construct” approval, have been obtained, and a power purchase agreement is finalized with the Ontario Power Authority. The construction period is estimated to be approximately 8 to 12 months in duration, with Project commissioning anticipated in the late summer of 2013.

1.2 Objective and Scope

The Design and Operations Report (hereinafter referred to as “the Report”) is required as a part of an application for all renewable energy projects that must submit in order to obtain a REA permit under Ontario Regulation (O. Reg.) 359/09 – *Renewable Energy Approvals Under Part V.0.1 of the Act*. The Report needs to clearly define the following:

- the site plan
- the design of the facility and the equipment to be used
- how the Project will be operated
- how environmental effects will be monitored and mitigated
- how emergencies and communications will be managed.

The Report also functions as a communication tool for Aboriginal, public, agency and municipal consultation. A draft of the Design and Operations Report must be made public 60 days prior to the second public consultation meeting in accordance with Section 16 of O. Reg. 359/09 and provided to the Aboriginal communities more than 60 days prior to the second public consultation meeting.

Section 2 of the Report provides the site plan and describes the Project area features. Section 3 provides the plan for the facility design including a description of the facility components. Section 4 describes the facility operation plan and Section 5 provides the environmental effects monitoring

plan for the operation of the Project. Section 6 describes the emergency response and communications procedures planned for the Project.

2. Site Plan

The solar Project is located on privately owned land, approximately 82 ha in size. The site is approximately 5 km southeast of Grenier with access via Glackmeyer Concession Road 9 (municipal road) from the north. The coordinates (longitude and latitude) of the leased land are 49.141101 and -80.984888. Appendix A shows the detailed site plan of the Project. The site plan includes the facility components such as the construction staging area, the area for PV modules, the location of each inverter, the transformer and the substation. The Project's Location components will also be identified, such as the Project boundary and the proposed set back, the access roads, the drainage system, the surrounding area, etc.

The transmission line Project is predominantly located on public land in association with municipal road right of ways along Concession 8 and 9 (Glackmeyer and Clute), but some private property will be crossed and Northland has acquired easements through the affected parcels of private land.

The design and operation plan for each of these components is described in the subsequent sections. For additional information regarding the construction and installation of these components, please refer to the Construction Plan Report (Hatch 2012g).

The site plan also provides the location of the noise receptors as defined by O. Reg. 359/09. The Noise Study (Hatch Ltd., 2012a) provides the detailed information on the noise sources, noise receptors and setback requirements. The site plan also includes the location of all Project area features within 125 m and 300 m.

A description of the specific features can be found as follows:

- natural heritage features can be found in the Natural Heritage Records Review Report (Hatch Ltd., 2012b), Natural Heritage Site Investigation Report (Hatch Ltd., 2012c) and Natural Heritage Evaluation of Significance Report (Hatch Ltd., 2012d) for the Project
- waterbodies can be found in the Water Body Records Review Report (Hatch Ltd., 2012e) and the Waterbodies Site Investigation Report (Hatch Ltd., 2012f) for the Project
- socio-economic conditions can be found in the Section 3 of the Construction Plan Report (Hatch Ltd., 2012g)
- archaeological assessments, if applicable, can be found in the Stage 1 and 2 Archaeological Assessment completed for the Project (ARA, 2011).

3. Facility Design Plan

3.1 Site Constraints/Regulations

Based on the results of the natural heritage and water body environmental studies, as identified above, constraints to development on the Project Location include a 30-m setback for solar panels and electrical equipment from the average annual high water mark of the watercourses.

These constraints have been integrated and taken into consideration in the facility design plan.

3.2 Facility Components

3.2.1 Civil Components

3.2.1.1 Security Gate, Fencing and Lighting

The site will be gated and fenced, with additional security measures installed as required by Northland. The fence design includes a chain-link fence, about 2 m high, with barbed wire on top of the fence. Inner fencing will also be erected around the substation area.

A set of lights will be installed near the entrance to the facility. Security and/or work lights located at inverter buildings may be on at night. They may be operated using motion control sensors. Wherever / whenever possible, lights will remain off at night, to minimize any potential nuisance. Additional timed, motion-sensor security lighting may be installed.

3.2.1.2 Access Roads and Internal Road System

As outlined in the site plan, a new access road will be necessary to support construction activities and will provide access to the site during the operation phase of the Project. The proposed approximately 5-m wide access road will have ditches, swales and culverts (where necessary) for proper stormwater run-off, site drainage and to minimize road and soil erosion.

In addition to the main access road, a number of smaller access roads will be constructed. These will be approximately 5 m wide within the leased area.

Finally, an access road will be constructed, via a culvert, across Munroe Creek to the adjacent Abitibi Solar Project. Road width will again be approximately 5 m wide.

3.2.1.3 Drainage System

There is one unnamed watercourse originating in the north/northwestern portion of the property, flowing in a northwesterly direction off the Project Location. This watercourse would drain the northern half of the Project Location. There are two grassed swales draining from the woodland in the west-central portion of the Project Location toward Munroe Creek, which is situated approximately 120 m each of the Project Location. The southern end of the Project Location would drain west, toward an unnamed tributary on the adjacent property, and east, toward Munroe Creek. A 30-m setback will occur from the high water mark of each of the waterbodies.

Based on site visits and preliminary assessments, the existing drainage system appears to be adequate for the operations of the Project; however, grading may be required to ensure appropriate drainage of the property. In general, the drainage system for the facility will follow the existing drainage system on site. Run-off from the modules will not result in the requirement for drainage channels within the module rows. Drainage channels may be required along access roads to convey run-off.

3.2.1.4 Foundations

Foundation construction for electrical equipment, substation, and transformer oil spill containment basin comprises of excavation and removal of in situ material, placement of granular material, formwork, reinforcing steel, grounding, and placement of concrete. PV modules will be securely mounted on a lattice type structure supported by a driven pile foundation, helical pile, micro-pile, ground screw, Cast-In-Drilled-Hole (CIDH) pile, and/or a pile inserted into a blasted hole, depending

on the soil conditions within the site. These underground support structures will be installed to a design depth below the frost line, capable of supporting the structure.

3.2.1.5 *Trenches for Electrical Cables*

Trenches will be excavated for electrical cabling (including DC cables from the modules to the inverter and AC cables from the inverters to step-up transformers). Trenches will be sufficiently wide enough to accommodate horizontal installation of DC and/or AC cables (including spacing between cables as specified by the engineer). Trenches will be excavated to a minimum depth corresponding to the ground cover requirements as per the Ontario Electrical Safety Code (typically 0.9-1.0 m). In the event of excess rock in the bottom of the trench, Northland may choose to bury electrical cables at a shallower depth and provide mounding over the top of the trench, such as to meet Ontario Electrical Safety Code requirements pertaining to required ground cover over buried cables. The method of trench excavation will be selected based on ground conditions. Though, potential excavation methods include a 'ditch-witch' plough, hoe-ram, blasting, or similar equipment. Where necessary, conduits, as approved by the electrical safety code, of suitable diameter will be provided to cross underneath access roads.

3.2.1.6 *Structural Support for PV Modules*

The structural support for the PV Modules will be comprised of a steel and/or aluminum racking structures. This racking structure will be mounted on the piles.

3.2.1.7 *Temporary Construction Staging Area*

The construction staging and laydown area will be located at the north end of the Project Location. The north end of the Project Location is in close proximity to the proposed substation, maintenance building and long-term parking area. Fill material, including Granular A and B will be used to create a stable base.

3.2.1.8 *Maintenance Building*

An approximately 7 m x 7 m maintenance building will be constructed adjacent to the facility parking lot. The building will include a single man door and steel rollup door constructed entirely of non-combustible material. The maintenance building will be used for storage of maintenance equipment/materials. It is anticipated that there will be no storage of chemicals, such as transformer oil, within the maintenance shed.

3.2.2 **Electrical Equipment**

The Project is designed to generate 10 MW (AC) by using seven blocks of photovoltaic modules. Each block has a nominal capacity of 1.428 MW AC and is comprised of two arrays, each with one inverter with a nominal capacity of 714 kW. The modules, inverters, intermediate transformers, AC switch, main step-up transformer, and the equipment control and monitoring system are the main electrical components of a solar facility. General information is provided below. Equipment grounding will comply with the requirements of the Ontario Electrical Safety Code.

3.2.2.1 *Modules*

It is expected that MEMC 310 W multi-crystalline solar modules will be utilized for the Project (see specifications sheet in Appendix B). The dimensions of the modules are 1976 mm by 990 mm by 50 mm, and each weighs 22.2 kg. Each module contains 72 multi-crystalline silicone solar cells, and is covered by a 3.2-mm thick tempered glass, and framed in anodized aluminum alloy. Modules will be connected together in series into "strings", and these strings will be brought to combiner boxes. If

other modules are used they could range in output between 290 and 320 W, but they would have the same physical dimensions. The only thing that changes is the type and efficiency of the crystalline silicon that is used in the modules' cells, for example mono versus poly crystalline.

At this stage, Northland is negotiating with different construction contractors and conducting further optimization studies for the Project. As such, specific details such as exact number of modules, spacing and setting of the modules are not available.

3.2.2.2 *Inverter*

At this stage, Northland is completing market research and negotiating with different manufactures for the supply of inverters. Additionally, the requirements for grid interconnection as defined by Hydro One are evolving and will impact the final selection of the inverter for this Project. As such, the final determination as to which inverter will be used for this Project has not been made.

At this stage, Northland has selected a representative inverter for the purposes of initial design and noise modeling (see Appendix B for specifications). This inverter was chosen as it possesses representative noise characteristics for inverters of its size. Two 714-kW inverters will be housed inside a common enclosure, with one 1.6 MVA intermediate (approximate) transformer immediately adjacent to and outside of the enclosure. Each 714-kW inverter is 256 cm by 228 cm by 96 cm (H x W x D) in size, and weighs 1800 kg. Inverter enclosures will sit on (cast in place or pre-cast) concrete pads/vaults. Comparable inverters made by the other manufacturers have similar dimensions, and are of similar weight.

3.2.2.3 *Intermediate Transformers*

Intermediate transformers will "step up" the power from 360 V to 27.6 kV. They will be located immediately adjacent to the inverter enclosures, on a common skid. The skid is mounted on a (cast-in-place or pre-cast) concrete pad.

3.2.2.4 *Medium Voltage Switchgear*

A medium voltage switchgear will be provided to couple the electrical output of the inverter intermediate transformers onto a common electrical bus, and to facilitate subsequent connection to the Main Step-Up Transformer.

3.2.2.5 *Service Equipment*

Every 1.6-MVA inverter enclosure will have station service power. The purpose of this service is to have power available as required for maintenance and general work on the solar array, and for enclosure heaters and cooling fans (if required). Service equipment will be mounted in cabinets appropriate for outdoor use.

3.2.2.6 *Electrical System*

PV modules are proposed to be arranged in seven power blocks, with two 714-kW inverters at the center of each block. The nameplate capacity of each module in an array will be approximately 310 W, but could range between 290 to 320 W. There will be sufficient modules for each inverter to optimize inverter loading. Modules will be strung together in strings of approximately 18 modules. These strings will be brought to combiner boxes. From each combiner box, a single run of DC conductors (two conductors per run, each of positive DC polarity) will be brought to an inverter. Inverters convert the DC power collected into AC power, and this will be stepped up by transformers adjacent to the inverters to a planned intermediate voltage of 27.6 kV. Medium voltage collection

will be by a combination of underground cable and overhead distribution line. Buried cables will include ground cover as required by the Ontario Electrical Safety Code. Buried cables will be laid in a trench with a layer of sand above and below, and the trench will then be filled in with the original local material or imported. There will also be a caution tape buried in the trench halfway between the ground and the buried cables. After filling, the trenches will be graded to bring the land back to its original contours. Additional drainage features (culverts, ditches) may be installed to restore the natural drainage prior to the Project development and will have minimum impact to the local flora and fauna. Where trenching is not possible due to encountered rock or other reasons, above ground cable-trays, cable mounding, and/or hoe-ram/blasting techniques may be used.

Conductors at the intermediate 27.6-kV voltage will be routed to a 27.6-kV substation, from which a single feeder line (overhead or underground) will run to the transformer substation on the Martin's Meadows Solar Project Location, where a main transformer will step power up to 115 kV. The feeder lines will typically cross fields within the Project Locations and will not run adjacent to the existing roadways. All feeder lines will be located above ground. It is expected that the above ground overhead lines would be supported by single poles although in some cases, double poles could be required (due to soil conditions, angles in the line, etc.).

3.2.2.7 *Transformer Substation on Martin's Meadows Solar Project Location*

Construction of the transformer substation will include excavation of topsoil, installation of ground grid, foundation construction, covering of surface area with crushed stone, and installation of electrical equipment and teleprotection tower. The substation area will be fenced and appropriately signed for safety and security purposes.

Three (3) single walled transformers, one for each of the Abitibi, Martin's Meadows and Empire Solar Projects, will be required to increase the voltage of the electricity from 27.6 kV to 115 kV. The higher voltage is required to allow connection with the provincial grid (Hydro One Circuit C2H). The sub-station will be an outdoor, air-insulated facility containing three inverter step-up transformer units, breakers, switches as well as auxiliary services equipment. The sub-station will be surrounded by a security fence and will have lighting. The sub-station will require an approximate area of 75 m x 75 m of land (see Appendix A for coordinates of the substation; a figure is provided in Hatch, 2012g). All transformers will be oil filled and will sit in an oil spill containment system to prevent ground contamination in the event of a release. The transformer will be equipped with level gauges to monitor gas and oil levels. Unusual gas and/or oil levels will trip an alarm to a remote monitoring station.

3.2.2.8 *Transformer Substation Electrical Building*

The substation electrical building will house the electrical control and monitoring systems. It is anticipated that the building will be prefabricated and brought to site in two pieces on transport trucks. The foundation requirements for the electrical building will be as specified by the engineer.

3.2.2.9 *115-kV Transmission Line*

From the step-up transformer, a 115-kV single-circuit transmission line will be constructed to connect the project to the existing Hydro One transmission system circuit C2H. Two potential points of interconnection and three potential overhead line routing options were considered, as outlined below.

- Option 1: Point of Connection No. 1 located at the intersection of Concessions 8 and 9 and Highway 668 – The overhead transmission line will go along Concessions 8 and 9 using Transmission Line A.
- Option 2: Point of Connection No. 2 at the intersection of Concessions 6 and 7 and Highway 668. The overhead transmission line will run along Concessions 8 and 9 using Transmission Line A then head south along Highway 668 using Transmission Line C.
- Option 3: Point of Connection No. 2 at the intersection of Concessions 6 and 7 and Highway 668. The overhead transmission line will go along Concessions 8 and 9 then head south along Highway 636 and west along Concessions 6 and 7 using Transmission Line B.

At the request of local residents, an additional option (Option 4) was considered, which would primarily consist of Option 2; however would follow the existing Algonquin Power transmission line from Concession 8 and 9 to Highway 668.

The preferred interconnection option as selected by Northland is Option 1, given the reduced length of the transmission line when compared to all other options, the reduced amount of vegetation removal, when compared to Option 4, and the allowance for a single connection point associated with all of Northland's solar projects in northeastern Ontario.

The 115-kV transmission line will be supported using either single or double poles. Typical span lengths between poles are 90 to 125 m. Poles will be approximately 75 ft tall, though 9 ft of this length will be embedded into the native soil, so only approximately 66 ft will be above ground. The transmission line is largely contained within municipal road rights-of-way (21 m width or 66 ft) and some unopened road allowances. Some private property will be crossed and Northland has acquired, or is in the process of acquiring, easements through the affected parcels of private land.

Several crossings of watercourses and other local infrastructure will be required:

- It is proposed that the 115 kV above ground line will go underground to cross existing H2O Power and Hydro One (C2H, C3H) transmission lines, and Highway 668. These underground lines will "daylight" at a small switching station at the tap-in point on Hydro One circuit C2H. A transition station (approximately 15 m x 25 m), required to transition the line from overhead to underground, will be placed in a fenced yard on privately owned land at the intersection of Highway 668 and Concession 8 and 9.
- Other crossings, such as the Ontario Northland Railway and Algonquin Power's 115-kV line are currently in the design phase. Crossing will be completed in accordance with all applicable regulations and guidelines.
- All of the watercourses, including the Frederick House River, will be spanned with overhead lines and there would be no effect to these watercourses. Descriptions of these crossings are provided in the Construction Plan Report and Waterbodies Environmental Impact Study Report.

As the 115-kV Transmission Line will be constructed within municipal road ROW in an unorganized township, this portion of the Project will require use of Crown Land. Northland is currently in discussions with the Ontario Ministry of Natural Resources (MNR) to ensure that all appropriate permits and approvals are obtained for the Project. At this time, it is anticipated that the Project will

require a Memorandum of Understanding, land use permits and easements, work permits, and forest resource licence (for any removal of trees from Crown Land).

3.2.2.10 Connection/Switching Station

A connection/switching station (approximately 75 m x 75 m), located on privately owned land, west of and adjacent to Hydro Ones line, will be required in order to connect to the C2H circuit at the point of connection with the provincial grid. This switching station is proposed at the south west corner of the intersection of Concession 8 and 9 and Highway 688, west and adjacent to the existing Hydro One overhead line.

The switching station will include breakers and disconnect switches to allow isolation of the solar plants and their transmission line from the Hydro One transmission system.

3.2.3 Stormwater Management/Erosion and Sediment Control

As stated above, drainage channels may be required along access roads to manage run-off. The design of the drainage channels/swales will be in accordance with industry standards. Erosion and sediment control measures and flow dissipaters (e.g., silt fence barriers, straw bale flow checks, rock flow check dam, revegetation) will be installed to ensure that the receiving water body is protected from erosion and sedimentation.

The entire site, with the exception of the access roads, will be revegetated with native grass or other suitable ground cover to promote surface water infiltration/uptake, prevent erosion and provide wildlife habitat.

3.2.4 Water Supply and Sanitary System

The Project does not require any water during operation other than potentially for cleaning the PV modules. It is anticipated that the rain and snow will generally be sufficient for this purpose; if not, Northland will contact local suppliers to provide water in tankers from off-site sources.

Only trained personnel will work at the Project on an intermittent/regular basis and operation is controlled remotely. Therefore, sanitary facilities and drinking water are not anticipated to be required on site. If it is determined to be required, portable toilets, serviced by a local sanitation company, will be used to service the site.

4. Facility Operation Plan

4.1 Operations

As stated previously, the Project does not require any permanent on-site operator as it will be operated remotely. For general monitoring and maintenance purposes, local personnel may be hired and will be dispatched from a central operations office as needed. Any damage or faults with the PV modules and electrical systems will be alerted to staff remotely and repaired (or replaced) by facility staff or qualified professionals. Access to the site will be limited to Project personnel.

Any waste generated during the operations will be removed from the site and managed according to provincial and municipal requirements.

4.2 Maintenance

The vegetation coverage, drainage systems and trees will be monitored and maintained as required. Suitable ground cover will be established under the modules and some form of vegetation abatement

may be required several times throughout the summer months. Approved control procedures will be used for this vegetation control.

Vegetation within the transmission line ROW will be periodically managed in accordance with Independent Electricity System operator (IESO) requirements as required to ensure that vegetation does not come in contact with the transmission lines. Vegetation management will be completed through mechanical means to the maximum extent possible. Northland may, where permissible and controlled by regulation, use herbicides to manage vegetation along the transmission line, in particular for areas that are difficult to access. Northland will not use herbicides or pesticides at the solar developments in the fields to control grass. Mechanical grass cutting will be used for the solar farms. Northland will avoid the use of herbicides along the transmission line route if possible.

As previously described, the need to clean the solar modules will be determined according to local weather conditions, such as the quantity and frequency of rain and snow at the Project Location. At the very most, it is expected that the modules will require cleaning quarterly, but it is possible cleaning the modules will not be necessary at all. If required, water trucks will bring water to the site to supply the water required. Other panel maintenance activities required to ensure proper functioning will be completed as required.

The transformers will be visually inspected on a monthly basis and their status recorded. Any leaks will be repaired immediately. Spill response equipment will be left on site or in the maintenance trucks should leaks be observed.

The site will also be visually inspected for any erosion or sedimentation issues and remediation will be implemented as necessary to prevent environmental impacts.

5. Environmental Effects Monitoring Plan

The Technical Bulletin for Preparing the Operations and Design Report requires that an environmental effects monitoring plan be prepared that will show how the negative environmental effects will be mitigated and monitored to comply with O. Reg. 359/09.

As per the Technical Bulletin, the environmental effects monitoring plan for the design and operations phase of the Project can be comprised of summary tables, text descriptions and references to other. More specifically, the following are required:

1. A summary of all potential negative environmental effects caused by the project as given in the description of negative environmental effects in the Project Description Report.
2. Performance objectives for each potential negative effect, such that, if the performance objective is achieved, the effect will be substantially mitigated.
3. A description of all mitigation strategies planned to achieve performance objectives.
4. If there is an ongoing risk of potential negative environmental effects, a description of how the project will be monitored to ensure that mitigation strategies are meeting performance objectives
5. Contingency measures will be provided should monitoring reveal that negative effects are continuing to occur.

With respect to requirement 1 above, several Project reports have determined and documented the potential negative environmental effects. These reports and the context of the potential negative environmental effects are as follows:

- Project Description Report – preliminary potential negative environmental effects for features within 300 m of the Project
- Construction Plan Report – potential negative environmental effects caused by construction activities for features within 300 m of the Project
- Noise Report – potential negative environmental effects caused by transformers and inverters during operations on the receptors
- Stage 1 and 2 Archaeological Assessment – potential negative effects to archaeological resources from construction activities
- Natural Heritage Environmental Impact Study – potential negative effects to significant natural heritage features within 120 m of the Project for construction, operation and decommissioning phases
- Waterbodies Environmental Impact Study – potential negative effects to waterbodies within 120 m of the Project for construction, operation and decommissioning phases.

A summary of the potential negative environmental effects due to operational activities and proposed mitigation measures is provided in Table 5.1. However, due to the amount of public concern expressed with respect to the potential health effects of the transmission line associated with the Project, a separate discussion is provided below.

With respect to requirements 2 to 5 above, several Project reports have included environmental effects monitoring plans. These reports and the context of the monitoring plans are as follows:

- Natural Heritage Environmental Impact Study – monitoring requirements for natural features within 120 m of the Project for construction, operation and decommissioning phases.
- Waterbodies Environmental Impact Study – monitoring requirements for waterbodies within 120 m of the Project for construction, operation and decommissioning phases.

Table 5.2 identifies (i) the potential negative effects that have an ongoing risk of occurrence throughout the operational period, (ii) the performance objectives and mitigation strategies to address those effects, (iii) monitoring protocols to confirm that performance objectives are being met and (iv) contingency measures in the event that objectives are not being met, as identified in the reports listed above. Table 5.2 also provides the monitoring plan for those environmental effects that were not included in the reports above, as per the definition of “environmental effects”. These include potential effects to the social and economic environments.

5.1 115-kV Transmission Line Health Effects

Concerns with health effects from transmission lines are typically associated with electromagnetic fields (EMF). Electromagnetic fields (EMF) consist of a mix of electric and magnetic waves travelling together at the speed of light (World Health Organization (WHO), 1998)). Magnetic fields are caused by the motion of an electric current, such as in a transmission or distribution line. Magnetic

fields are measured in microtesla units (μT) and are proportional to current; however, in the case of three phase power, (such as is associated with the 115-kV transmission line), the three fields tend to cancel each other out at any one time, so the magnetic effect is only proportional to the leakage. The amount of leakage depends upon the configuration of the transmission line. Magnetic fields are also strongest closest to their source and diminish in strength with distance from the source (WHO, 1998).

WHO (2007) indicates that magnetic field strength is not dependant on voltage, although higher voltage transmission lines usually produce higher magnetic fields. The National Institute of Environmental Health Science (NIEHS), 1995 found that magnetic fields from a 115-kV transmission line generated a magnetic field of 6.3 μT maximum during Peak times on the right-of-way and 3 μT maximum on the right-of-way during average usage. Field strength decreased to 1.4 μT at a distance of 15 m from the line, and 0.04 μT at a distance of 91 m from the line (NIEHS, 1995; cited in WHO, 2007). WHO also studied the strength of magnetic fields generated from typical appliances in the home. They found that washing machines generated magnetic fields between 0.1 and 3 μT and microwave ovens generated magnetic fields between 0.1 and 20 μT (WHO, 2007). Thus, the magnetic field generated from the proposed transmission line will be within the range, and possibly significantly lower than magnetic fields generated in the home, from things like hair dryers, toasters, TV's, etc. Please see the attached IEEE figure, which depicts typical EMF levels form common household items, and shows EMF levels for power lines connecting to homes.

WHO (2007) conducted a review of the potential health effects of magnetic fields. They found that there may be some acute (short term) biological effects due to exposure to magnetic fields in the range of up to 100 kHz. WHO (2007) therefore, recommended that exposure limits be set to prevent adverse effects and stated that international guidelines already exist to address this issue. Regarding longer term effects, WHO (2007) found that "consistent epidemiological evidence suggests that chronic low intensity ELF magnetic field exposure is associated with an increased risk of childhood leukemia. However, the evidence for a causal relationship is limited, therefore exposure limits based upon epidemiological evidence are not recommended, but some precautionary measures are warranted. Similarly, Health Canada, in its brochure entitled: Electric and Magnetic Fields at Extremely Low Frequencies, Updated January 2010 IT'S YOUR HEALTH, states:

"You do not need to take action regarding daily exposures to electric and magnetic fields at extremely low frequencies. There is no conclusive evidence of any harm caused by exposures at levels found in Canadian homes and schools, including those located just outside the boundaries of power line corridors.

This brochure also states:

"Health Canada does not consider guidelines for the Canadian public necessary because the scientific evidence is not strong enough to conclude that exposures cause health problems for the public."

Further, the Federal Provincial Territorial Radiation Protection Committee (FPTRPC), in Canada concluded from a review of all available evidence that "adverse health effects from exposure to power-frequency (e.g., transmission line frequency) EMFs, at levels normally encountered in homes, schools and offices, have not been established (FPTRPC, 2005a).

There are no national standards for residential or occupation exposure to EMF in Canada (FPTRPC, 2005b); however, some countries have adopted standards for exposure, particularly for sensitive members of the population. For example, Italy recommends a goal of 10 μT for children's playgrounds, residential dwellings, schools and areas where people stay for more than 4 hours per day (FPTRPC, 2005b). They also state a quality goal of 3 μT for new power lines in neighbourhoods (FPTRPC, 2005b). These guidelines and goals are higher than the expected exposure levels to the fields generated by the proposed transmission line from a distance of 15 m during peak times (1.4 μT).

In summary, even if the fields are measured directly beneath the transmission line, the effect of the electric field and the magnetic fields would be very small, probably even less than would be encountered in the average home. Therefore, based on this review, no adverse health effects due to EMF are predicted to occur as a result of the 115-kV transmission line and no mitigation measures are therefore necessary.

Table 5.1 Summary of Potential Negative Environmental Effects and Proposed Mitigation Occurring During Operations Phase

Environmental Component	Sources of Negative Effect	Potential Negative Effect	Mitigation Measures	Residual Negative Effect
Vegetation Communities/ Wildlife Habitat	Changes in site topography, placement of Project components, access roads, ditches and other less pervious areas.	Increase in surface water runoff.	Native plant cover planted around Project components instead of hay fields. Ditches and drainage conveyance features installed during construction activities will remain in place.	None. Native vegetation will maintain surface water management functions provided by existing hay fields.
	Accidental spills from transformer.	Adverse effects on vegetation and soil due to contamination.	Transformer to be placed within an oil containment pit. Spill control kits on site. Spill response procedure implemented in the event of an accident.	None – oil containment at main transformer will prevent releases to the environment in the event of a spill. No adverse effect anticipated.
Wildlife Communities	Maintenance activities.	Disturbance of wildlife due to noise and human presence resulting in wildlife avoidance of Project Location.	None.	None – Disturbance to wildlife due to maintenance activities less than existing disturbance due to agricultural activities.
Groundwater	Accidental spills from transformer.	Adverse effects on groundwater quality due to contamination.	Transformer to be placed within an oil containment pit. Spill control kits on site. Spill response procedure implemented in the event of an accident.	None – oil containment at main transformer will prevent releases to the environment in the event of a spill. No adverse effect anticipated.
Surface Water, Aquatic Habitat and Biota	Accidental spills from transformer.	Adverse effects on surface water quality due to contamination.	Transformer to be placed within an oil containment pit. Spill control kits on site. Spill response procedure implemented in the event of an accident.	None – oil containment at main transformer will prevent releases to the environment in the event of a spill. No adverse effect anticipated.
	Erosion due to surface water runoff from the Project area.	Adverse effects on water quality and aquatic habitat in receiving waterbodies.	Dense vegetation cover beneath solar modules and in ditches on the Project Location.	None – provided mitigation is effective in preventing erosion and sedimentation.
	Washing of solar modules during maintenance activities.	Increase in surface water runoff and impact to surface water quality.	Rainfall is expected to be sufficient or water will be brought on site for cleaning purposes. If water from off-site is required, the amount used will be less than that occurring during a normal rainstorm event.	None – mitigation anticipated to be effective in preventing residual negative effects.
	Changes to surface water quality and surface water runoff rate as a result of the Project.	Indirect effect to the aquatic biota and habitat in receiving waterbodies.	Proposed mitigation for surface water quality and surface water runoff is anticipated to be sufficient to prevent adverse effects on aquatic biota and habitat.	None – mitigation anticipated to be effective in preventing residual negative effects.
Sound Levels	Noise emissions from transformer and Inverters.	Disturbances to nearby receptors due to noise emissions.	Installation of noise barrier around transformer if required to meet performance objectives.	Noise emissions will meet provincial requirements at nearest sensitive receptors.
Public and Facility Safety	Installation of the facility.	Installation of the facility will result in a potential risk to the public and facility, should trespassing on site occur.	Public access to the facility will be prevented through the use of fences, gates, and any other necessary security procedures.	Elimination or reduction in risk to public and facility safety.
Change in Visual Landscape	Installation of the facility.	Installation of the facility will result in a change to the local landscape. This may be perceived as a negative environmental effect.	Visual barriers will be considered, if necessary, and will be reviewed based on viability and effectiveness.	Elimination or reduction in visual disturbance of the facility if visual barriers implemented.
Property Values	Installation of the facility.	Installation of the facility has the potential, though unproven, to result in a change in the value of nearby properties based on aesthetic preference of potential landowners. Though subjective, the potential reduction in property values for the purpose of this assessment is considered a potential negative effect.	No mitigation measures are proposed.	Potential reduction in property value.

Blank back

Table 5.2 Environmental Effects Monitoring Plan – Design and Operations

Negative Effect	Mitigation Strategy	Performance Objective	Monitoring Plan				Contingency Measures	
			Methodology	Monitoring Locations	Frequency	Rationale		Reporting Requirements
Increases in surface water runoff from Project Location.	Storm water management measures including enhanced vegetated swales, ditch flow controls and filter strips.	Minimize changes to surface water runoff conditions to receiving waterbodies.	Visual assessment of structural stability of mitigation measures and identification of unintended impacts.	Throughout Project Location.	Twice per year during site inspections.	Visual monitoring will confirm that stormwater management measures remain as designed and allow identification of deficiencies.	Reported in annual operational environmental monitoring report.	Stormwater management measures will be remediated as necessary to ensure that they are functioning as designed.
Erosion and sedimentation resulting in increased turbidity in site runoff.	Vegetation to prevent erosion due to stormwater runoff.	No long-term erosion from site over and above existing conditions.	Visual monitoring of Project area to identify areas of erosion (e.g., rills, gullies).	Throughout Project Location.	Twice per year during site inspections.	Visual monitoring of erosion would identify potential areas of concern.	Reported in annual operational environmental monitoring report.	Erosion remediated as necessary to ensure no long-term erosion issues.
Potential for adverse surface water, groundwater and soil quality due to accidental spills.	Standard mitigation to prevent spills and minimize magnitude of spills that do occur. Installation of secondary containment around transformer.	No long-term environmental effects due to spills.	Visual monitoring of spill prevention/mitigation measures during maintenance activities.	Throughout Project Location where maintenance occurs and at transformer location.	Twice per year during site inspections.	Spill prevent and control measures to be monitored to ensure they are functioning as designed and protocols are being implemented as specified in plans to meet performance objectives.	Reported in annual operational environmental monitoring report.	Spill contingency measures implemented as necessary in the event of a spill. Following spill event, response will be reviewed to determine if additional or altered response protocols are necessary to meet performance objectives.
Noise levels disturbing nearby noise receptors.	Noise mitigation strategies including installation of sound dampening equipment in the enclosures and/or a noise barrier around transformer and separate inverter and transformer locations to minimize cumulative noise emissions.	To minimize noise emissions at nearby noise receptors to the provincial guideline values.	Sound level monitoring as per any requirement documented in the REA issued for the Project.	At the closest sensitive receptors.	As per the frequency documented in the REA issued for the Project.	Auditory monitoring will confirm that noise emissions from the Project meet performance objectives.	Reported in annual operational environmental monitoring report.	If Project components are not meeting performance objectives with respect to noise emissions, noise barriers will be installed as necessary.
Installation of the facility will result in a potential risk to the public and facility, should trespassing on site occur.	Public access to the facility will be prevented through the use of fences, gates, and any other necessary security procedures.	Elimination of risk to public safety.	Site security monitoring will be ongoing to confirm adequacy of security measures.	Throughout the Project location and facility perimeter.	Ongoing.	Site security monitoring will identify any breach in facility security.	Incidents of trespassing or vandalism will be reported to local authorities. Internal reporting to be determined by Northland.	Additional security measures will be implemented as required.
Installation of the Project will result in a change to the local landscape. This may be perceived as a negative environmental effect.	Visual barriers will be implemented as necessary.	Elimination/reduction in visual disturbance.	Concerns and complaints regarding visual disturbance and adequacy of visual barriers will be documented by the proponent.	To be determined.	As required.	Documentation of visual disturbance and adequacy of visual barriers by local residents will result in evaluation of visual barrier necessity or effectiveness.	Internal reporting to be determined by Northland.	Visual barriers will be installed/ upgraded as necessary.

Blank back

6. Emergency Response and Communications Plan

6.1 Emergency Response

The Project Emergency Response Plan will be implemented through all phases of the Project. The purpose of the plan is to establish and maintain emergency procedures required for effectively responding to accidents and other emergency situations, and for minimizing associated losses.

Potential emergency scenarios which could occur during the construction, operation and decommissioning phases include, fire, personal injury and spills incidents. The following provides the emergency response and communications procedures to be used in response to these three potential emergency scenarios.

All Project personnel will be trained in the following emergency response and communications procedures.

Note that during the operation of the Project, Northland will establish a Communication and Emergency Response Plan to react to any Project specific emergencies. In the event of an emergency, Northland will mobilize its resources to the site to respond to the event.

6.1.1 Fire

Fire extinguishers will be located in strategic locations, such as Project vehicles and the substation electrical building. If a fire occurs, Project personnel will attempt to extinguish it, only if it is safe to do so. If there is any risk of personal injury, extinguishing the fire will not be attempted. If a fire cannot be extinguished using the hand held extinguishers, the Project area will be evacuated and Project personnel will immediately call 911 to summons the local fire department (and ambulance if required). Project personnel will notify inhabitants at all adjacent properties, if the fire appears able to move off of the Project Location. All staff on site during the life of the Project will be trained in the procedure to deal with a fire and the use of an extinguisher.

During operations, a visible sign will be erected near the front gate of the facility. The sign will include instructions to call 911 and to call a Project phone number should a passerby notice an emergency. In the event of an emergency, Project personnel at site will contact 911 and the Project Manager.

All incidents will be documented and kept on file. Documentation will include date of incident, date of reporting, name of reporter, description of the incident, cause of the incident, actions taken, communications to outside groups and internal personnel and follow-up required.

6.1.2 Personal Injury

Should a personal injury occur on site that does not require an ambulance, the injured worker will be taken to the local hospital. First aid supplies and maps to the local hospitals will be kept in the Project trailer. A listing of the Project personnel trained in first aid/CPR will also be posted.

Should a personal injury occur on site that does require an ambulance, Project personnel will call 911 and assist the injured worker as required until emergency personnel arrive.

In all cases of personal injury, the Project Manager during the construction and decommissioning phases and the Northland Project Representative during operations will be notified immediately.

All incidents will be documented and kept on file. Documentation will include date of incident, date of reporting, name of reporter, name of injured, description of the incident, cause of the incident, actions taken, communications to outside groups and internal personnel and follow-up required, as required by Health and Safety Regulations.

6.1.3 Spills

The following spills procedures are as outlined in the Ministry of Environment's (MOE) "Spills Reporting – A Guide to Reporting Spills and Discharges" dated May 2007. Spills and the types of spills that require reporting are defined in the *Ontario Environmental Protection Act* and O. Reg. 675/98 Classification and Exemption of Spills and Reporting of Discharges.

Spills are the unintended release/discharge of material to air, land or water. The most likely decommissioning spill scenarios include: the release of sediments to waterbodies, sewage from portable washrooms and hazardous materials (e.g., compressed gases and petroleum hydrocarbons) from containers or vehicles.

Spills prevention measures are documented in the Environmental Impact Studies report completed for the Project. Should a spill occur, the following will be implemented:

1. Evaluate the scene for risks to human health and safety.
2. Stop the spill, if it is safe to do so.
3. If there is immediate danger to human health, contact 911 for assistance, and notify anyone who may be directly impacted or is in harm's way.
4. During the construction and decommissioning phases notify the Project Manager of the incident, and notify the "Project Representative" during the operations phase.
5. Contain and clean-up the spill, using on-site spill kit.
6. If required, contact outside spill response contractor for assistance.
7. Document and report the spill to outside agencies, as required.

A spill kit will be available on-site during the decommissioning phase and will contain equipment necessary for spills response. This will include absorbent pads, absorbent boom, polyethylene bags, neoprene gloves, protective goggles, plastic bin or metal drum, and multi-purpose granular sorbents.

Spills that could potentially occur during the life of the Project, and may need to be reported to the MOE include

- non-approved releases/discharges (including those to land, air and water)
- discharge of fluids greater than 100 L from a vehicle
- mineral oil releases greater than 100 L from an electrical transformer
- discharges (including sediment) to waterbodies.

The MOE Spills Action Centre phone number (1-800-268-6060) will be posted at the Project trailer.

Documentation for all spill incidents will be kept on file and sent to the MOE, as required. Documentation will include date of incident, date of reporting, name of reporter, description of the incident, cause of the incident, type and amount spilled, actions taken, disposal of contaminated material, communications to outside groups and internal personnel and follow-up required.

6.2 Communications Plan for Non-Emergencies

A sign will be erected during all phases of the Project at the gate of the facility which will include a Project phone number and website should the public have any questions, inquiries or complaints. All inquiries will be directed to the Northland Project Representative who will respond to the inquiry accordingly. All questions, inquiries and complaints will be logged electronically with the following information: date of question, inquiry or complaint, name, phone number, email address of the individual, response, date of response, and any follow-up issues.

During all phases of the Project should such conditions arise that the general public requires notification (such as Project changes requiring notifications), the public will be notified through newspaper and direct/general mailout, if required. Should agencies, such as the local municipality or the Ministry of the Environment, require notification, they will be sent the information directly by email, mail or telephone conversation. All communications will be documented and kept on file by Northland.

7. References

Archaeological Research Associates Ltd. (ARA). 2011. Stage 1 and 2 Archaeological Assessment, Martin's Meadows Solar Project. Prepared for Hatch Ltd.

Federal Provincial Territorial Radiation Protection Committee – Canada (FPTRPC). 2005a. Position Statement for the General Public on the Health Effects of Power-Frequency (60 Hz) Electric and Magnetic Fields – Issued on January 20, 2005.

FPTRPC. 2005b. Health Effects and Exposure Guidelines Related to Extremely Low Frequency Electric and Magnetic Fields – an Overview. Prepared by the ELF Working Group. Online at <http://www.labour.gov.sk.ca/adx/asp/adxGetMedia.aspx?DocID=1351,1350,1191,94,88,Document&MediaID=783&Filename=health-effects-and-exposure-guidelines-overview.pdf>. Accessed January 17, 2010. Hatch Ltd. 2012a. Martin's Meadows Solar Project Solar Project – Noise Assessment Study. Prepared for Northland Power Inc.

Hatch Ltd. 2012b. Martin's Meadows Solar Project Solar Project – Natural Heritage Records Review Report. Prepared for Northland Power Inc.

Hatch Ltd. 2012c. Martin's Meadows Solar Project Solar Project – Natural Heritage Site Investigations Report. Prepared for Northland Power Inc.

Hatch Ltd. 2012d. Martin's Meadows Solar Project Solar Project – Natural Heritage Evaluation of Significance Report. Prepared for Northland Power Inc.

Hatch Ltd. 2012e. Martin's Meadows Solar Project Solar Project – Water Body Records Review Report. Prepared for Northland Power Inc.

Hatch Ltd. 2012f. Martin's Meadows Solar Project Solar Project – Water Body Site Investigation Report. Prepared for Northland Power Inc.

Hatch Ltd. 2012g. Martin's Meadows Solar Project Solar Project – Construction Plan Report. Prepared for Northland Power Inc.

Health Canada. 2010. It's Your Health – Electric and Magnetic Fields at Extremely Low Frequencies. Available online at: <http://www.hc-sc.gc.ca/hl-vs/iyh-vsv/environ/magnet-eng.php>. Accessed September 14, 2012.

National Institute of Environmental Health Sciences. 2002. EMF – Electric and Magnetic Fields Associated With the Use of Electric Power. 65pp. Available on line at http://www.niehs.nih.gov/health/assets/docs_p_z/results_of_emf_research_emf_questions_answers_booklet.pdf

World Health Organization (WHO). 2007. Extremely Low Frequency Fields – Environmental Health Criteria Monograph No. 238. Online at http://www.who.int/peh-emf/publications/elf_ehc/en/index.html. Accessed January 23, 2012.







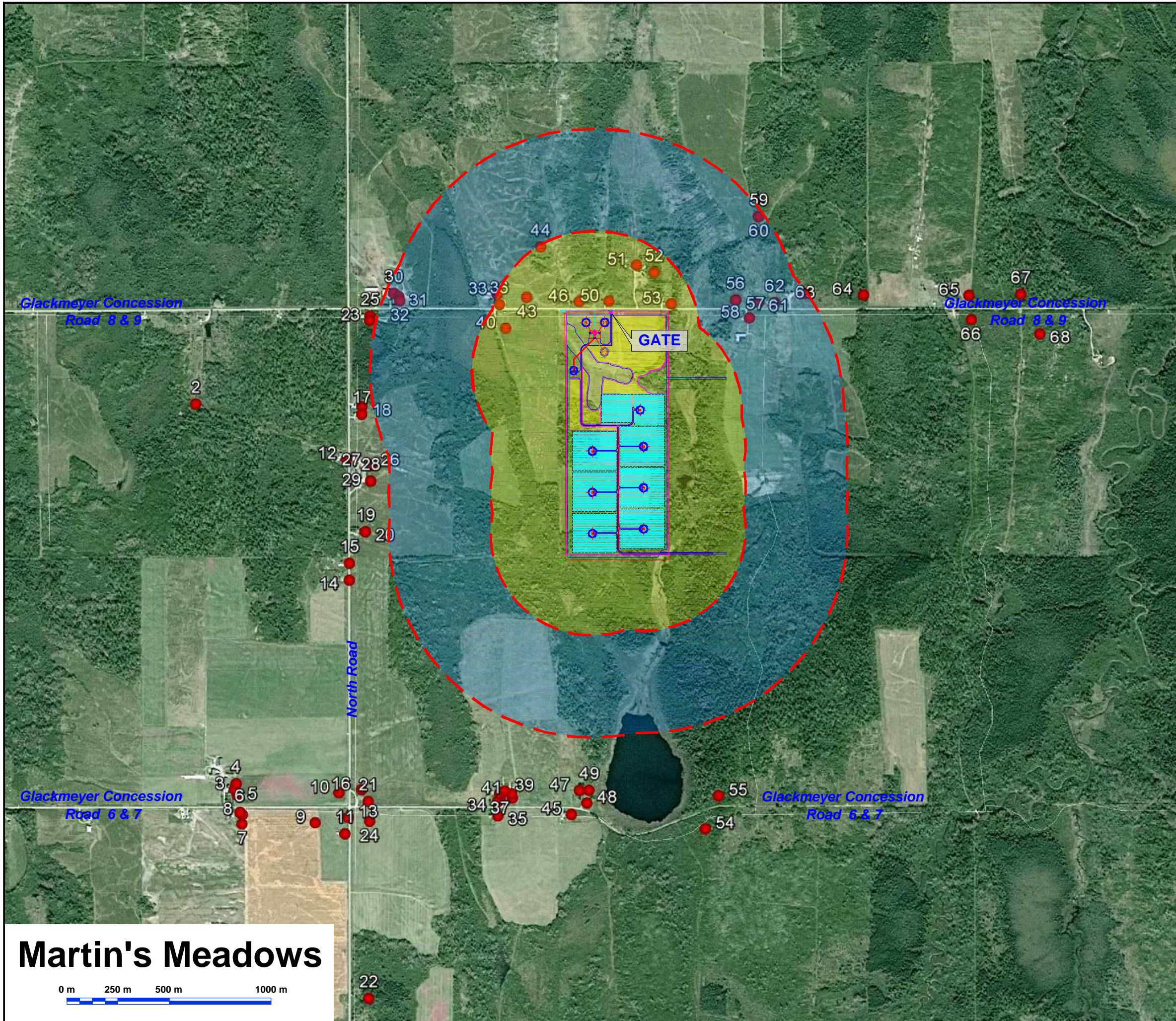



WHO. 1998. Electromagnetic Fields and Public Health: Extremely Low Frequency (ELF). Fact Sheet No. 205. Accessed January 19, 2012.

Appendix A

Preliminary Layout



LEGEND:

-  GRAVEL ACCESS ROAD
-  OVERHEAD 115 kV LINE
-  OVERHEAD 27.6 kV LINE
-  PROPERTY BOUNDARY / FENCE LINE
-  AVAILABLE AREA BOUNDARY
-  CONSTRUCTION LAYDOWN AND POTENTIAL SOLAR MODULES AREA
-  500 m RADIUS FROM NOISE SOURCES
-  1 km RADIUS FROM NOISE SOURCES
-  SOLAR BLOCK
-  NOISE RECEPTOR LOCATION
-  INVERTER'S TRANSFORMER & SUBSTATION'S TRANSFORMER

INVERTER'S TRANSFORMER (UTM Co-ordinate)		
17 U	X (m E)	Y (m N)
P1	501216.50	5443158.16
P2	501234.60	5442978.96
P3	501234.60	5442777.36
P4	501234.60	5442575.76
P5	500983.17	5442553.41
P6	500983.17	5442755.01
P7	500983.17	5442956.56

27.6 kV SUBSTATION'S TRANSFORMER (UTM Co-ordinate)		
17 U	X (m E)	Y (m N)
P8	500891.19	5443116.43

115 kV/SWITCHING SUBSTATION'S TRANSFORMERS (UTM Co-ordinate)		
17 U	X (m E)	Y (m N)
P9	500978.58	5443536.02
P10	500993.60	5443521.00
P11	501008.62	5443536.02



Martin's Meadows



PRELIMINARY LAYOUT
NOT FOR CONSTRUCTION

GOOGLE SATELLITE MAP
IMAGERY DATE: AUG 17, 2003

Appendix B

Technical Specifications

MEMC



DRAFT



MEMC SILVANTIS™ 310W MODULE

MEMC is a recognized authority on silicon technology and manufacturing processes developed through more than 50 years of experience. With our vertically-integrated business model, MEMC delivers best-in-class solar modules by continuously leveraging new technology and manufacturing techniques that maximize efficiency, minimize cost, and extend product lifetime.

Our Solaicx® CCz solar modules address our core strategy to deliver high power energy solutions at the lowest cost per watt.

MEMC Silvantis solar module family continues our tradition of excellence by delivering the highest levels of performance and with over 40 locations worldwide, MEMC is dedicated to providing local, responsive customer service.



HIGH EFFICIENCY – 3 BUSBARS

SILVANTIS 310W modules are built with proprietary Solaicx® p-type CCz process with uniform resistivity and maximum efficiency.



QUALITY

Manufactured in automated, state-of-the-art facilities certified to ISO9001 and ISO14001 for highest industry standards.



1000 V UL

RELIABLE AND ROBUST DESIGN

1000 V UL by CSA, high-quality materials, ARC glass, and high-load capability are part of each module.

KEY FEATURES

- Solaicx CCz p-type Mono-crystalline wafer with high carrier lifetime that enables solar cells to operate at peak efficiency
- Advanced Mono-crystalline cells for higher conversion efficiency
- Textured glass with Anti-Reflective Coating (ARC) for superior energy production
- Positive power tolerance provide increased power output
- Withstands loads up to 5400 Pa as tested to IEC standards
- Non-corroding anodized aluminum frame for ruggedness
- Modules with a range of power output available

MODULE FAMILY

MEMC-M315AIC, MEMC-M310AIC MEMC-M305AIC

QUALITY & SAFETY

- IEC61215 certified by TÜV SÜD to ensure long-term operation in a variety of climates (pending)
- IEC61730 certified by TÜV SÜD to ensure electrical safety (pending)
- Stringent outgoing quality acceptance criteria benchmarked to industry standards
- UL1703 (1000 V) listed by CSA for Canada and USA (pending)
- CE marked and CEC listed (pending)

LINEAR WARRANTY INFORMATION

- 10-year limited warranty for materials and workmanship
- 25-year linear power warranty with coverage for power loss greater than 3.5% in the first year and 0.7% degradation per year thereafter
- Backed by MEMC



For more information about MEMC SILVANTIS Modules, please visit www.memc.com

310W SOLAR MODULE

MEMC



310W SOLAR MODULE DIMENSIONS mm[inch]

Module Dimensions		Cable Length
A – 990 [39.0]	D – 30 [1.2]	H – 1,000 [39.4]
B – 1,976 [77.8]	E – 22 [0.9]	
C – 50 [2.0]		
Mounting Hole Spacing		
F – 950 [37.4]	G – 1,188 [46.8]	

PHYSICAL PARAMETERS

Module Dimensions (mm)	1,976 x 990 x 50
Module Weight (kg)	22.2
Cell-Type	SolaiCx CCz Mono-crystalline
Number of Cells	72
Frame Material	Anodized Aluminum
Glass (mm)	3.2 Tempered ARC glass

TEMPERATURE COEFFICIENTS AND PARAMETERS

Nominal Operating Cell Temperature (NOCT) (°C)	46 ± 2
Temperature Coefficient of P _{max} (%/°C)	-0.45
Temperature Coefficient of V _{oc} (%/°C)	-0.34
Temperature Coefficient of I _{sc} (%/°C)	0.05
Operating Temperature (°C)	-40 to +85
Maximum System Voltage (V)	1000 (UL & IEC)
Limiting Reverse Current (A)	9.10
Maximum Series Fuse Rating (A)	15
Power Range (W)	-0/+5

Temperature coefficients may vary by ±10%

ELECTRICAL CHARACTERISTICS

Model #	MEMC-M305AIC	MEMC-M310AIC	MEMC-M315AIC
Rated Maximum Power P _{max} (W)	305	310	315
Open-Circuit Voltage V _{oc} (V)	45.8	45.9	46.0
Short Circuit Current I _{sc} (A)	9.00	9.02	9.05
Module Efficiency (%)	15.6	15.8	16.1
Maximum Power Point Voltage V _{mpp} (V)	36.8	36.9	37.0
Maximum Power Point Current I _{mpp} (A)	8.29	8.40	8.52

All electrical data at standard test conditions (STC): 1000W/m², AM1.5, 25°C
Electrical characteristics may vary by ±5% and power by -0/+5W

* Listed specifications are subject to change without prior notice.

IV CURVES AT MULTIPLE IRRADIANCES* [25°C]

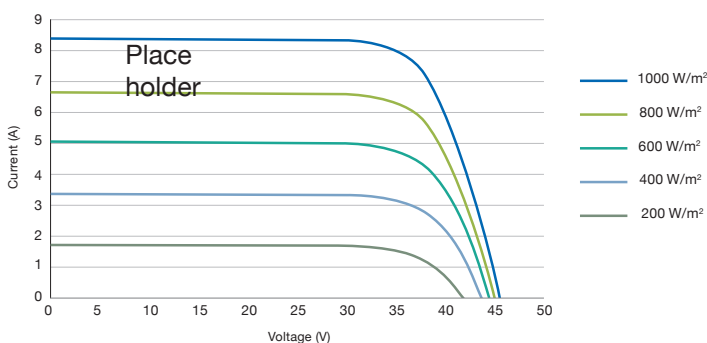

IV CURVES AT MULTIPLE TEMPERATURES* [1000 W/m²]

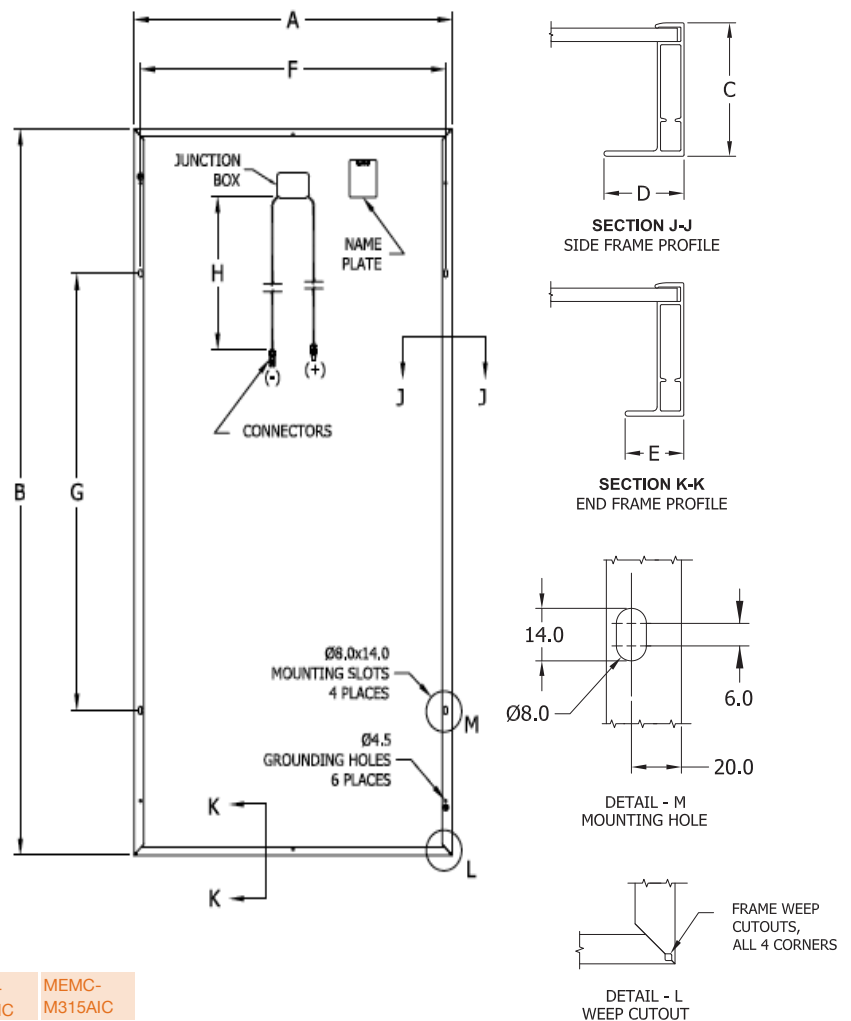
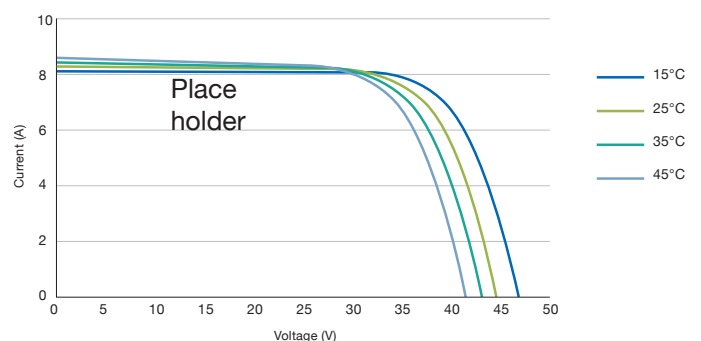



Efficient

- Without low-voltage transformer: greater plant efficiency due to direct connection to the medium-voltage grid

Turnkey Delivery

- With medium-voltage transformer and concrete substation for outdoor installation

Optional

- Medium-voltage switchgear systems for a flexible structure of large solar parks
- AC transfer station with measurement

- Medium-voltage transformers for other grid voltages (deviating from 20 kV)

SUNNY CENTRAL for Direct medium-voltage feed-in 800MV / 1000MV / 1250MV

High-performance medium-voltage station

For even more power: Two powerful Sunny Central HE inverters are components of a medium-voltage station (MV) which feeds directly into a shared medium-voltage transformer. In this way, for example, two Sunny Central 630HE inverters are combined into a powerful Sunny Central 1250MV station. The advantage: By removing the need for the low-voltage transformer, the plant operator realizes greater yields and at the same time lower inverter costs. The Sunny Central MV is delivered as a "turnkey" concrete substation for outside installation. On top of that, the Sunny Central MV actively participates in grid management, and thereby fulfils all requirements of the Medium-Voltage Directive valid as of July 2010.

SUNNY CENTRAL 800MV / 1000MV / 1250MV

Technical data	Sunny Central 800MV	Sunny Central 1000MV	Sunny Central 1250MV
Input data			
Nominal DC power	816 kW	1018 kW	1284 kW
Max. DC power	900 kW ¹⁾	1120 kW ¹⁾	1410 kW ¹⁾
MPP voltage range	450 V - 820 V ⁵⁾	450 V - 820 V ⁵⁾	500 V - 820 V ⁵⁾⁷⁾
Max. DC voltage	1000 V	1000 V	1000 V
Max. DC current	1986 A	2484 A	2844 A
Number of DC inputs	(16 + 16) + 4 DCHV	(16 + 16) + 4 DCHV	(16 + 16) + 4 DCHV
Output data			
Nominal AC power @ 45 °C	800 kVA	1000 kVA	1250 kVA
Continuous AC power @ 25 °C	880 kVA	1100 kVA	1400 kVA
Nominal AC voltage	20000 V	20000 V	20000 V
Nominal AC current	23.2 A	28.8 A	36.1 A
AC grid frequency 50 Hz	●	●	●
AC grid frequency 60 Hz	●	●	●
Power factor (cos φ)	0.9 leading ... 0.9 lagging		
Max. THD	< 3 %	< 3 %	< 3 %
Power consumption			
Internal consumption in operation	< 3000 W ⁴⁾	< 3000 W ⁴⁾	< 3000 W ⁴⁾
Standby consumption	< 180 W + 1100 W	< 180 W + 1100 W	< 180 W + 1350 W
External auxiliary supply voltage	3 x 230 V, 50/60 Hz	3 x 230 V, 50/60 Hz	3 x 230 V, 50/60 Hz
External back-up fuse for auxiliary supply	B 20 A, 3-pole	B 20 A, 3-pole	B 20 A, 3-pole
Dimensions and weight			
Height	3620 mm	3620 mm	3620 mm
Width	5400 mm	5400 mm	5400 mm
Depth	3000 mm	3000 mm	3000 mm
Weight	35000 kg	35000 kg	35000 kg
Efficiency²⁾			
Max. efficiency	97.7 %	97.9 %	97.8 %
Euro-eta	97.3 %	97.5 %	97.4 %
Protection rating and ambient conditions			
Protection rating (as per EN 60529)	IP54	IP54	IP54
Operating temperature range	-20 °C ... +45 °C	-20 °C ... +45 °C	-20 °C ... +45 °C
Rel. humidity	15 % ... 95 %	15 % ... 95 %	15 % ... 95 %
Fresh air consumption	12400 m ³ /h	12400 m ³ /h	12400 m ³ /h
Max. altitude (above sea level)	1000 m	1000 m	1000 m

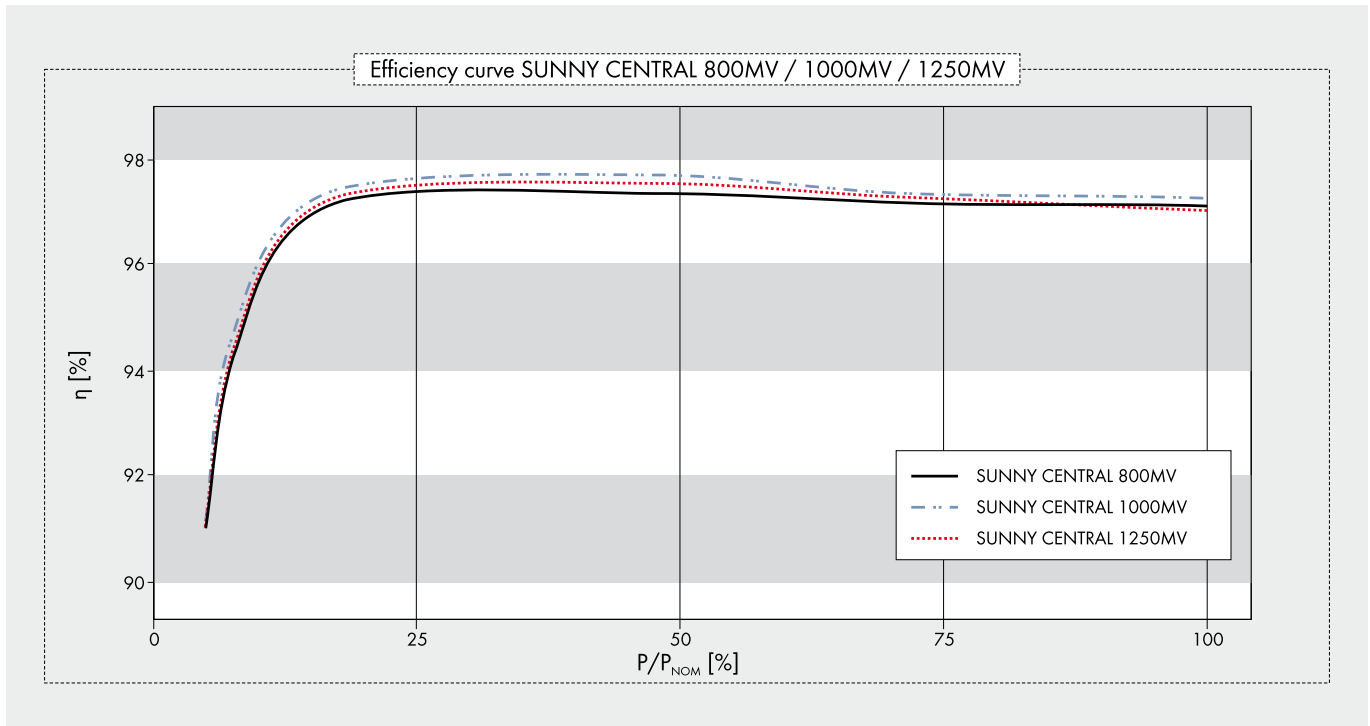

	Sunny Central 800MV	Sunny Central 1000MV	Sunny Central 1250MV
Features			
Display: text line / graphic	●/–	●/–	●/–
Ground fault monitoring	●	●	●
Heating	●	●	●
Emergency stop	●	●	●
Circuit breaker AC side	SI load disconnection switch	SI load disconnection switch	SI load disconnection switch
Circuit breaker DC side	Switch-disconnector with motor	Switch-disconnector with motor	Switch-disconnector with motor
Monitored overvoltage protectors AC / DC	●/●	●/●	●/●
Monitored overvoltage protectors for auxiliary supply	●	●	●
SCC (Sunny Central Control) interfaces			
Communication (NET Piggy-Back, optional)	analog, ISDN, Ethernet	analog, ISDN, Ethernet	analog, ISDN, Ethernet
Analog inputs	10 x A _m ³⁾	10 x A _m ³⁾	10 x A _m ³⁾
Overvoltage protection for analog inputs	○	○	○
Sunny String-Monitor connection (COM1)	RS485	RS485	RS485
PC connection (COM3)	RS232	RS232	RS232
Electrically separated relay (ext. alert signal)	2	2	2
Certificates / listings			
EMC	EN 61000-6-2 EN 61000-6-4		
CE conformity	●	●	●
BDEW-MSRL / FGW / TR8 ⁶⁾	●	●	●
RD 1633 / 2000	●	●	●
Arrêté du 23/04/08	●	●	●
● standard features ○ optional features – not available			
Type designation	SC 800MV-11	SC 1000MV-11	SC 1250MV-11

HE: High Efficiency, inverter without galvanic isolation for connection to a medium-voltage transformer (taking into account the SMA specification for the transformer)

1) Specifications apply to irradiation values below STC

2) Efficiency measured without an internal power supply at $U_{DC} = 500\text{ V}$

3) 2x inputs for the external nominal value specification for active power and reactive power, 1x external alarm input, 1x irradiation sensor, 1x pyranometer

4) Internal consumption at nominal power

5) At $1.05 U_{AC, nom}$ and $\cos \varphi = 1$

6) With limited dynamic grid support

7) At $f_{grid} = 60\text{ Hz}$: 510 V - 820 V

Please note: in certain countries the substations may differ from the substations shown in the images

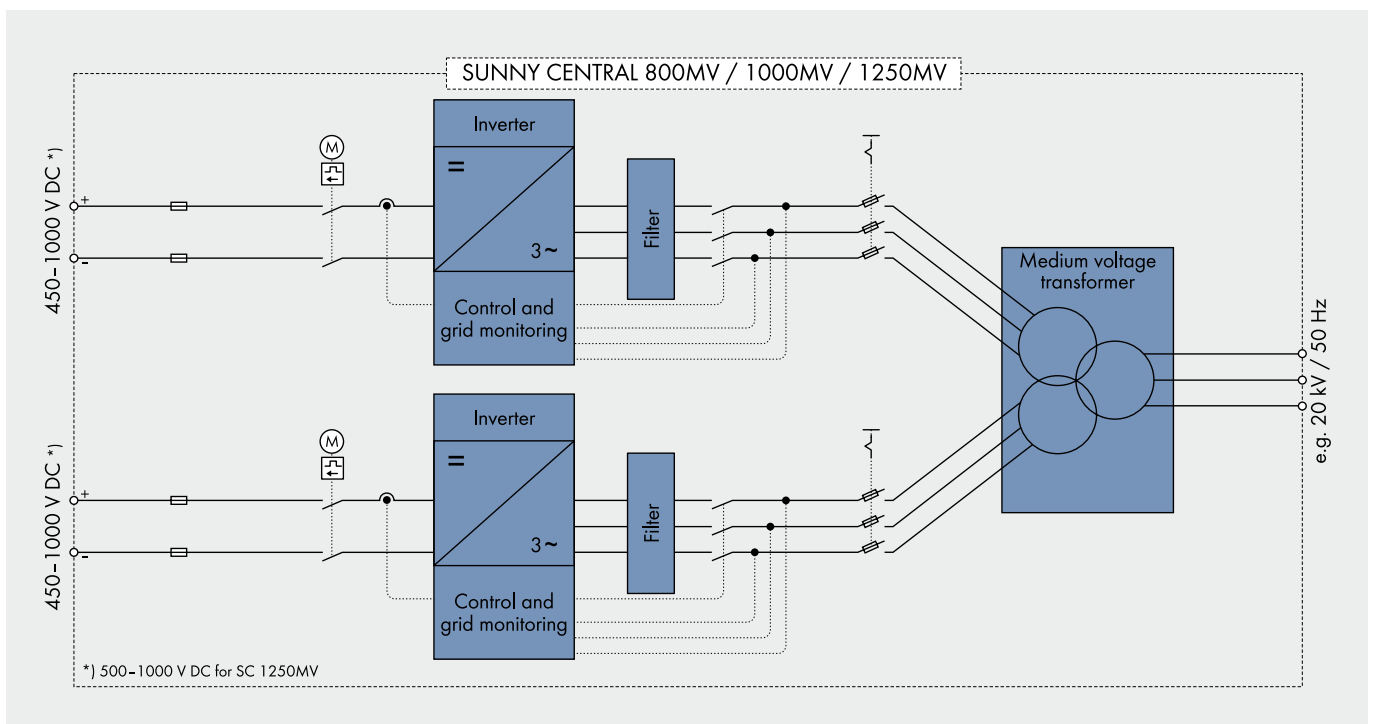

POWERFUL GRID MANAGEMENT FUNCTIONS

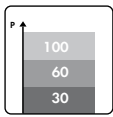

Remote controlled power reduction in case of grid overload

In order to avoid short-term grid overload, the grid operator presets a nominal active power value which the inverter will implement within 60 seconds. The nominal value is transmitted to the inverters via a ripple control receiver in combination with the SMA Power Reducer Box. Typical limit values are 100, 60, 30 or 0 per cent of the nominal power.

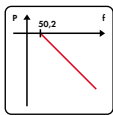

Frequency-dependent control of active power

As of a grid frequency of 50.2 Hz, the inverter automatically reduces the fed-in of active power according to a definable characteristic curve which thereby contributes to the stabilization of the grid frequency.

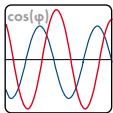

Static voltage support based on reactive power

To stabilize the grid voltage, SMA inverters feed reactive power (leading or lagging) into the grid. Three different modes are available:

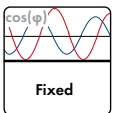

a) Fixed definition of the reactive power by the grid operator

The grid operator defines a fixed reactive power value or a fixed displacement factor between $\cos(\varphi)_{\text{leading}} = 0.90$ and $\cos(\varphi)_{\text{lagging}} = 0.90$.

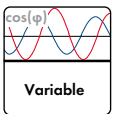

b) Definition of a dynamic setpoint of the reactive power by the utility operator

The grid operator defines a dynamic displacement factor - any value between $\cos(\varphi)_{\text{leading}} = 0.90$ und $\cos(\varphi)_{\text{lagging}} = 0.90$. It is transmitted either through a communication unit the evaluation can e.g. be evaluated and processed by the SMA Power Reducer Box.

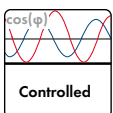

c) Control of the reactive power over a characteristic curve

The reactive power or the phase shift is controlled by a pre-defined characteristic curve - depending on the active power fed into the grid or the grid voltage.

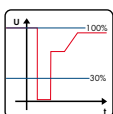

Limited Dynamic Grid Support

The inverter continues to feed to the grid after short term voltage drops - as long as the grid voltage is within a defined voltage window.

**SMA Solar Technologie Umrichteranlage Sunny Central SC 1000MV
Betrieb bei Nennleistung und 50 Hz; 1000 KW**

A - bewerteter Schalleistungspegel LwA re 1 pW [dB(A)]

IPK

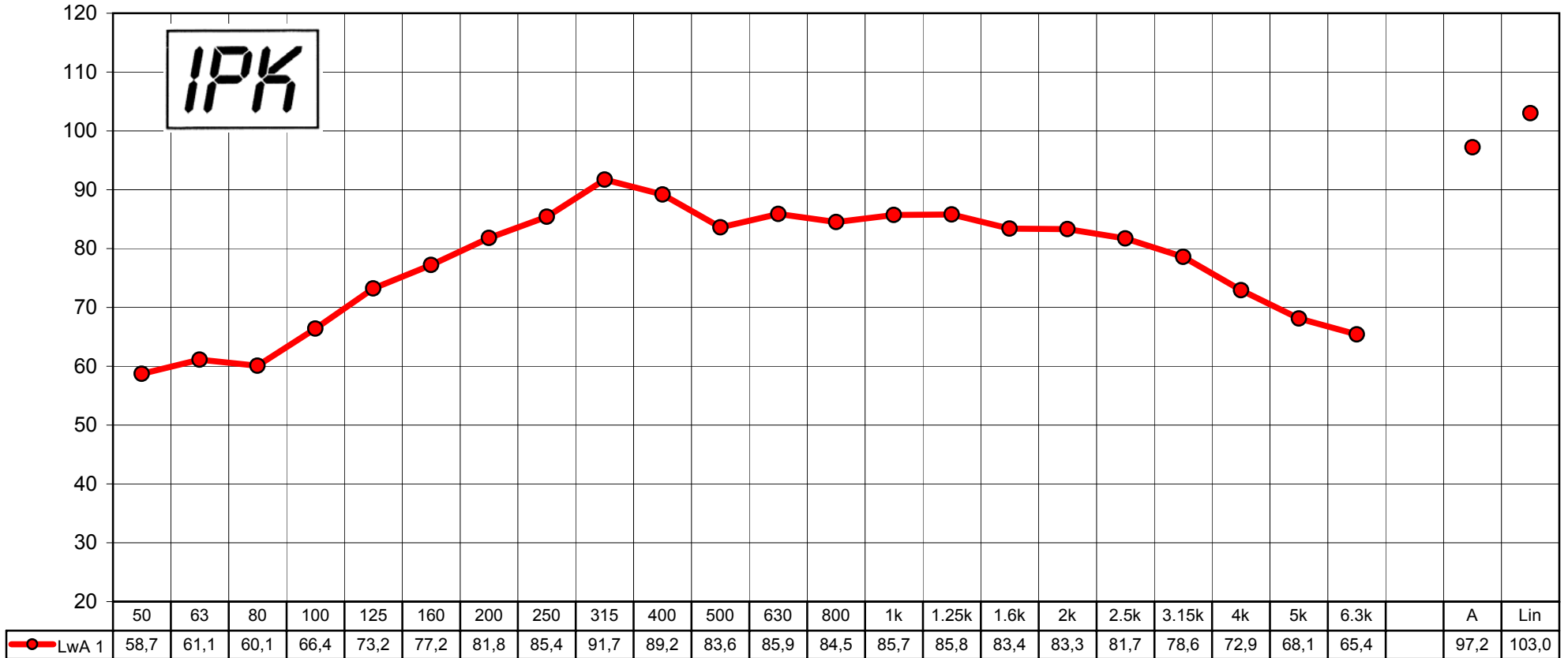

Terz - Mittenfrequenz [Hz]

From: Janos Rajda [mailto:Janos.Rajda@sma-america.com]
Sent: Monday, October 18, 2010 9:38 AM
To: Moran, Joaquin
Cc: Mike Lord; Chris Rytel; Elie Nasr
Subject: RE: Noise Levels - U R G E N T

Hi Joaquin,

Yes it will apply as two (2) 625kW, 60Hz are complete mechanical equivalents to two (2) 500kW, 50Hz or to a 1000kW 2-units system. The slight electrical difference between the two units relate to minimum DC voltage rating and grid frequency the units are connected to with no significant impact on levels of unit parts audio noise generation.

Regards,

Janos

From: Moran, Joaquin [mailto:JMoran@Hatch.ca]
Sent: October-18-10 9:13 AM
To: Janos Rajda
Cc: Mike Lord; Chris Rytel; Elie Nasr
Subject: RE: Noise Levels - U R G E N T

Hi Janos,

Thanks for the information. Just to clarify, the sound power levels provided seem to be for a 1000 kW unit, 50 Hz. Will these apply to the units to be deployed in this case (625 kW, 60 Hz)?

Cheers,

Joaquin

Joaquin E. Moran
Tel. +1 905 374-0701 x 5236

From: Janos Rajda [mailto:Janos.Rajda@sma-america.com]
Sent: Sunday, October 17, 2010 11:22 PM
To: Moran, Joaquin
Cc: Mike Lord; Chris Rytel; Elie Nasr
Subject: RE: Noise Levels - U R G E N T

Hi Joaquin,

Over the weekend we obtained third octave sound power levels for 100% or rated loading case for two SC units as supplied at the time for FirstSolar project in Sarnia.

Thanks again for providing as with sample data, which proved to be helpful in communicating the sound power level format requirement.

Best regards,

Janos

