



**NORTHLAND
POWER**

Abitibi Solar Project

Noise Assessment Study Report

October 18, 2012



Northland Power Inc.
on behalf of
Northland Power Solar
Abitibi L.P.
Toronto, Ontario

Noise Assessment Study Report

Abitibi Solar Project

H334844-0000-07-124-0249

Rev. 1

October 18, 2012

Disclaimer

This report has been prepared by or on behalf of Northland Power Inc. for submission to the Ontario Ministry of the Environment as part of the Renewable Energy Approval process. The content of this report is not intended for the use of, nor is it intended to be relied upon by, any other person. Neither Northland Power Inc. nor any of its directors, officers, employees, agents or consultants has any liability whatsoever for any loss, damage or injury suffered by any third party arising out of, or in connection with, their use of this report.

Executive Summary

This report presents the results of the Noise Assessment Study required for Solar Facilities under O. Reg. 359/09 and 521/10, as part of the Renewable Energy Approval (REA) Process. Northland Power Solar Abitibi L.P. (“Northland”) is proposing to develop a 10-Megawatt (MW) solar photovoltaic (PV) project titled Abitibi Solar Project (the “Project”). The Project will be located on approximately 45 hectares (ha) of land within the Town of Cochrane.

This Noise Assessment Study Report has been prepared based on the document entitled “Basic Comprehensive Certificates of Approval (Air) – User Guide” by the Ontario Ministry of the Environment (MOE, 2004). The sound pressure levels at the points of reception have been estimated using ISO 9613-2, implemented in the CADNA-A computer code. The performance limits used for verification of compliance correspond to the values for rural areas of 40 dBA. The results presented in this report are based on the best available information at this time. It is the intention that, in the detailed engineering phase of the project, certified noise data based on final plans and designs will confirm the conclusions of this noise impact assessment study.

The results obtained in this study show that the sound pressure levels at the Noise Receptors, resulting from the Project operation, will not exceed MOE requirements for rural areas of 40 dBA.

Project Report

October 18, 2012

**Northland Power Inc.
Abitibi Solar Project**

Noise Assessment Study Report

Table of Contents

**Report Disclaimer
Executive Summary**

1. Introduction	1
1.1 Project Description	1
1.2 Renewable Energy Approval Legislative Requirements	1
2. Facility Description	1
2.1 Project Location	2
2.2 Acoustical Environment	2
2.3 Life of Project.....	2
2.4 Operating Hours	2
2.5 Approach to the Study.....	2
3. Noise Sources.....	3
3.1 Substation Transformer.....	3
3.2 Inverter Clusters	4
3.3 Noise Summary Table.....	6
3.4 Adjacent Solar Projects.....	7
4. Noise Receptors and Points of Reception.....	8
5. Mitigation Measures.....	10
6. Impact Assessment	10
6.1 Compliance with Performance Limits.....	11
7. Conclusions and Recommendations	11
8. Signatures.....	15
9. References.....	16
Appendix A	Land Use Zoning Designation Plan and Area Location Plan
Appendix B	Noise Sources
Appendix C	Noise Receptor Coordinates and Noise Maps from CADNA-A
Appendix D	CADNA-A Sample Calculations

List of Tables

Table 2.1	General Project Description	2
Table 3.1	Noise Source Summary for the Project	7
Table 4.1	1.5-m Case – Point of Reception Noise Impact from Individual Noise Sources of Abitibi Solar Project	9
Table 4.2	4.5-m Case – Point of Reception Noise Impact from Individual Noise Sources of Abitibi Solar Project	10
Table 6.1	Performance Limits (One-Hour L_{eq}) by Time of Day for Class 3 Areas	10
Table 6.2	Calculated Sound Pressure Levels at POR used to Mode Noise Receptors within 1 km of Abitibi Solar Project	13

List of Figures

Figure 2.1	CADNA-A Configurations.....	3
Figure 3.1	Schematic Inverter Cluster Layout	5
Figure 3.2	Inverter Cluster CADNA-A Acoustical Model	6

1. Introduction

1.1 Project Description

Northland Power Solar Abitibi L.P. (“Northland”) is proposing to develop a 10-megawatt (MW) solar photovoltaic (PV) project titled Abitibi Solar Project (the “Project”). The Project will be located on approximately 45 ha of land within the Town of Cochrane.

The proposed Project is a renewable energy generation facility which will use solar photovoltaic technology to generate electricity. Electricity generated by solar photovoltaic panels will be converted from Direct Current (DC) to Alternating Current (AC) by inverter clusters which will also step-up the voltage to 27.6 kV. A main transformer, located in the substation, will step up the voltage from the clusters to 115 kV prior to being transmitted to the existing local distribution line.

In order to meet the Ontario Power Authority (OPA)’s Feed-In-Tariff (FIT) Program requirements, a specific percentage of equipment will be manufactured in Ontario.

The construction of the Project will begin once the Renewable Energy Approval (REA) has been obtained and a power purchase agreement is finalized with the OPA. The anticipated operational lifespan of the Project is 30 years.

1.2 Renewable Energy Approval Legislative Requirements

Ontario Regulation (O. Reg.) 359/09 and 521/10, made under the *Environmental Protection Act*, identify the Renewable Energy Approval (REA) requirements for green energy projects in Ontario. As per Section 4 of these regulations, ground mounted solar facilities with a name plate capacity greater than 12 kilowatts (kW) are classified as a Class 3 solar facility and, therefore, require an REA.

Section 13 of the O. Reg. 359/09 requires proponents of Class 3 solar facilities to complete a Noise Study Report in accordance with Appendix A of the publication; “Basic Comprehensive Certificates of Approval (Air) – User Guide, 2004” by the Ministry of the Environment (MOE, 2004).

The Noise Assessment Study Report is to include a general description of the facility, sources and Noise Receptors, Assessment of Compliance, as well as all the supporting information relevant to the Project. A draft of the Noise Assessment Study Report must be made available to the public, the local municipality and identified Aboriginal communities, at least 60 days prior to the final public consultation meeting in accordance with O. Reg. 359/09 and 521/10.

2. Facility Description

The Project will utilize photovoltaic (PV) panels installed on fixed racking structures mounted on the ground. The PV panels generate DC electricity which will be converted to AC electricity by inverters. The Project layout is based on seven inverter clusters each one containing two inverters and one medium-voltage (360-V/27.6-kV/1.6-MVA) transformer, and one 27.6-kV/115-kV/10-MVA substation transformer. The 27.6-kV power, collected from the inverter clusters, will be stepped up to 115 kV by the substation transformer prior to being transmitted to the existing local distribution line.

Since the panels will be ground mounted and the total nameplate capacity is over 12 kW, the Project is considered to be a Class 3 Solar Facility according to the classification presented in O. Reg. 521/10.

Table 2.1 General Project Description

Project Description	Ground-mounted Solar PV, Class 3
System Nameplate Capacity	10 MW AC
Local Distribution Company	N/A

2.1 Project Location

The Project Location¹ will be on privately owned land, zoned as rural and agricultural, totalling approximately 45 ha. Figure A.1 in Appendix A shows the zoning designation plan. Figure A.3 and Figure A.2 present the Project Area Location Plan, as well as the adjacent solar facilities proposed in the vicinity of the Project.

2.2 Acoustical Environment

The Project will be surrounded by forested areas to the west, south and east, and mainly farmland to the north. The background noise levels are expected to be typical of rural areas, classified as a Class 3 based on Publication NPC-232 by the MOE. Some traffic noise is expected from Glackmeyer Concession Road 8 and 9 on the northern boundary of the site, mainly during day hours. The Cochrane Airport is located about 4.5 km southwest of the Project Location. The Town of Cochrane is situated approximately 8 km to the south and the Trans-Canada Highway passes through Cochrane at a distance of about 9 km from the Project Location.

2.3 Life of Project

The expected life of the Project is 30 years. The manufacturer's warranty on the PV modules is 25 years and the expected life of solar power plants of this type is typically 35 to 40 years. At that time (or earlier if the 20-yr power purchase agreement is not extended), the Project will be decommissioned or refurbished depending on market conditions and/or technological changes.

2.4 Operating Hours

Solar PV facilities produce electricity during the day hours, when the sun rays are collected by the panels. After sunset the facility will not receive solar radiation to generate any electricity. Under these conditions the inverters will not produce any noise and the transformers will be energized, but not in operation (no fans in operation).

2.5 Approach to the Study

The sound pressure levels at the points of reception (POR) were predicted using procedures from ISO 9613-2, which is a widely used and generally accepted standard for the evaluation of noise impact in environmental assessments. The sound power level for the inverters was provided by the manufacturer while the sound power level for the transformers was estimated. The software package CADNA-A, which implements ISO-9613-2, was used to predict the noise levels at the POR. This numerical modeling software is able to simulate sound sources as well as sound mitigation measures taking into account atmospheric and ground attenuation. Some of the CADNA-A configurations used in the modeling are shown in Figure 2.1.

Elevation contours were not included in the CADNA-A model. This conservative approach was applied in order to avoid including any barrier effects of ground surface obstacles.

¹ "Project Location" in the context of this study is an area occupied by the Project infrastructure.

For modeling purposes, the vegetation that blocks some of the POR from the sources has not been incorporated.

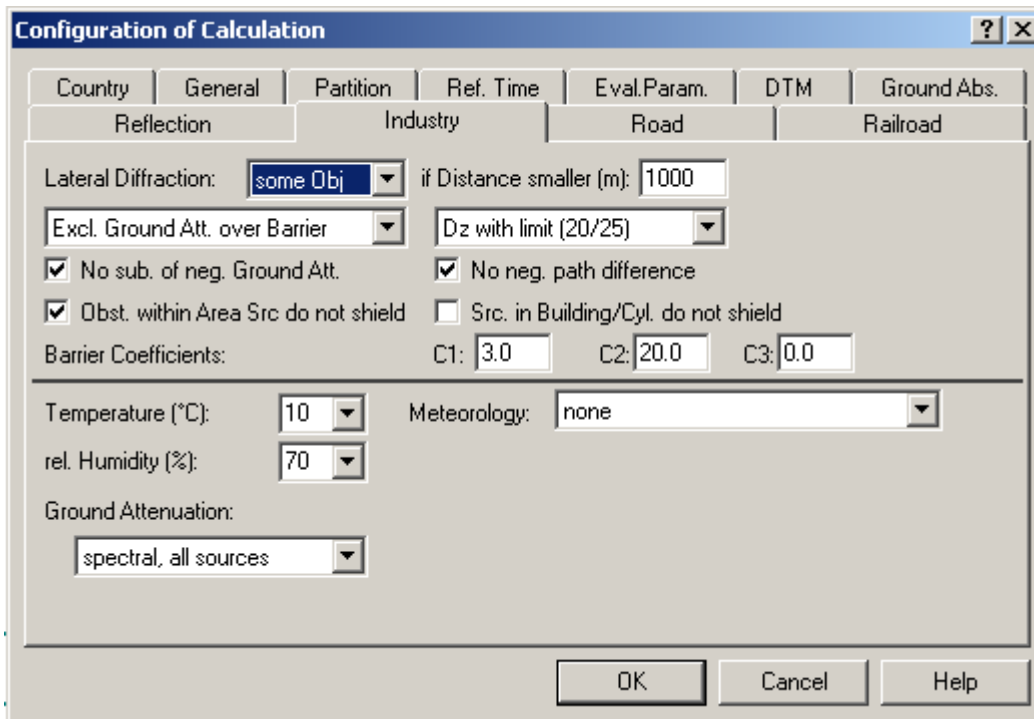

Figure 2.1 CADNA-A Configurations

3. Noise Sources

The main sources of noise from the Project will be seven inverter clusters, each one containing two inverters and one medium-voltage transformer, and a substation containing the main step-up transformer. The Project layout is provided in Figure A.3. The coordinates of each noise source are presented in Table B.1 of Appendix B. It should be noted that the 27.6-kV/115-kV/10-MVA transformer will be located on the Martin's Meadows Project Site and will be positioned in close proximity to the Martin's Meadows and Empire Solar Project 27.6-kV/115-kV/10-MVA transformers. Even though these sources are detailed in their respective project reports, all three projects (Martin's Meadows, Abitibi and Empire) were modelled together to accurately determine the contribution from all noise sources.

All noise sources were modeled as non-directional point sources.

Switchgear and a small step-down transformer used for lighting, located at the substation, do not emit any significant noise and consequently have not been considered as sources of noise.

For the purpose of this study it is assumed that all inverters and transformers will be operating 24 hours at full capacity.

3.1 Substation Transformer

A 10-MVA step-up transformer that will step up the 27.6-kV power to 115 kV, required by the local distribution company, will be located in the substation. Since the transformer make and model has

not been selected at this point (although it is known that the transformer will be of ONAF (oil natural air forced) type), a conservative estimate of sound power level was based on the data from NEMA TRI – 1993 (2000) and 58.7-m² transformer surface area. This standard provides maximum sound level values for transformers, and manufacturers routinely meet this specification. Since the sound power levels derived from NEMA overestimate the actual sound emissions of modern transformers due to the fact that the noise data is based on older and noisier transformers, Northland has committed to procuring a transformer that is at least 5dB less than the NEMA estimate. The NEMA levels were then converted into frequency spectra using empirical correlations for transformer noise (Stevens & Hung). This calculation is available in Figure B.3 of Appendix B. Northland has committed to using a transformer that meets the frequency spectra presented in Table B.3 of Appendix B. The transformer configurations are expected to be similar to those shown in Figure B.2. Noise source height representing the transformer was assumed at 3.6 m above grade.

Power transformers are considered by the MOE to be tonal noise sources. A 5-dB penalty was added to the sound power spectrum, as recommended by Publication NPC-104, “Sound Level Adjustments” for tonality. Table B.3 in Appendix B shows the frequency spectrum used to model the substation transformer.

3.2 Inverter Clusters

Northland is planning to use inverters manufactured by SMA. Seven inverter clusters will be installed as part of the Project. Each cluster comprises of two SMA Sunny Central 800CP inverters and one medium voltage transformer. A schematic layout with approximate dimensions of such cluster is available in Figure 3.1; additional information regarding details of the inverter cluster can be found in Appendix B. The cluster components listed above were modeled as point sources shown in Figure 3.2. *Note that the planned enclosure over the inverters was not taken into account as a mitigation measure in the noise model.*

The installed capacity of each Sunny Central 800CP inverter is 800 kW. SMA provided third-octave noise data for the Sunny Central 800CP inverter (Figure B.1 of Appendix B). The provided third octave spectrum was converted to a full octave spectrum and the contribution from two inverters was combined into a single sound power spectrum for use with CADNA-A model (calculations are available in Figure B.4 of Appendix B). A 5-dBA penalty was added to the frequency spectrum, as stipulated in Publication NPC-104, “Sound Level Adjustments,” to allow for tonality. The frequency spectrum used to model combined noise emission from the two inverters located next to each other within the same cluster is shown in Table B.3 of Appendix B. Table B. 4 of Appendix B contains coordinates of the individual inverters.

A 1.6-MVA transformer used to step-up the 360-V power from the inverters to 27.6 kV will be located in close proximity to the inverters. Since the transformer make and model have not been selected at this point (although it is known that the transformer will be of ONAN (oil natural air natural) type), the sound power levels resulting from the operation of the transformer were evaluated using data from NEMA TR 1-1993 (R2000) and 14.88-m² transformer surface area. The NEMA levels were then converted into frequency spectrum using empirical correlations for transformer noise (Crocker, 2007). This calculation is available in Figure B.5 of Appendix B. Power transformers are considered by the MOE to be tonal noise sources. A 5-dB penalty was added to the sound power spectrum, as recommended by Publication NPC-104, “Sound Level Adjustments” for tonality. Table

B.3 in Appendix B shows the frequency spectrum used to model the transformers located in the clusters.

Although for the modeling purposes it was assumed that the facility will operate 24 h at full capacity, in reality at night the facility will be idle. Under these conditions the inverters do not produce noise. The transformers (at the substation and clusters) are energized and make some magnetostrictive noise at a reduced level, but no cooling fans are in operation.

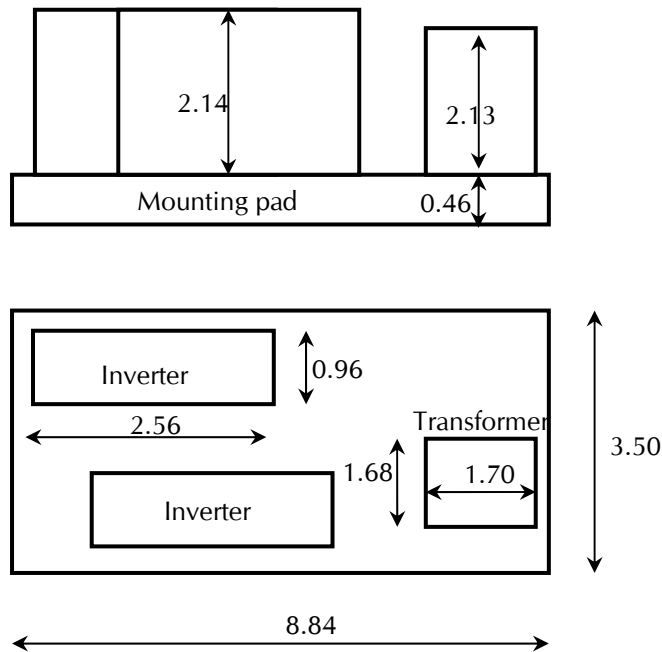

Figure 3.1 Schematic Inverter Cluster Layout
(all dimensions in metres)

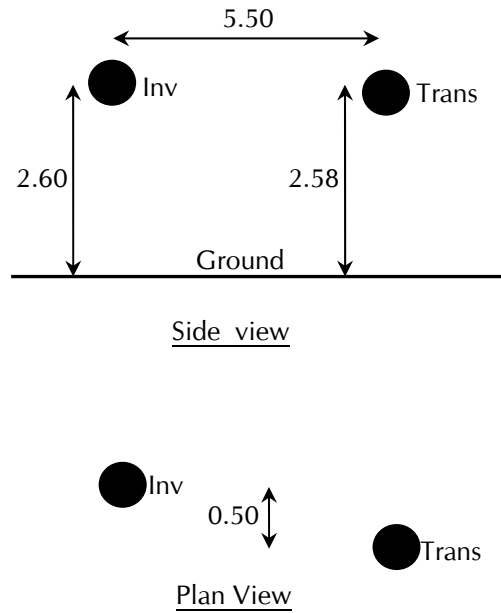

Figure 3.2 Inverter Cluster CADNA-A Acoustical Model

where: Inv = Noise Source Representing Two Sunny Central 800CP Inverters; and Trans = Noise Source Representing 360-V/27.6-kV/1.6-MVA Cluster Transformer (all dimensions in metres).

3.3 Noise Summary Table

A summary of the sound sources described above, including sound power level, characteristics and proposed noise control measures, is presented in Table 3.1.

Table 3.1 Noise Source Summary for the Project

Source ID	Description	Total Sound Power Level (dBA)	Source Location	Sound Characteristics	Noise Control Measures
AB_Sub115	27.6-kV/115-kV/10-MVA substation transformer	87.9	O	S-T	U
AB_Inv1	Two Sunny Central 800CP inverters at Cluster 1	91.3	O	S-T	U
AB_Inv2	Two Sunny Central 800CP inverters at Cluster 2	91.3	O	S-T	U
AB_Inv3	Two Sunny Central 800CP inverters at Cluster 3	91.3	O	S-T	U
AB_Inv4	Two Sunny Central 800CP inverters at Cluster 4	91.3	O	S-T	U
AB_Inv5	Two Sunny Central 800CP inverters at Cluster 5	91.3	O	S-T	U
AB_Inv6	Two Sunny Central 800CP inverters at Cluster 6	91.3	O	S-T	U
AB_Inv7	Two Sunny Central 800CP inverters at Cluster 7	91.3	O	S-T	U
AB_Trans1	360-V/27.6-kV/1.6-MVA cluster transformer at Cluster 1	80.1	O	S-T	U
AB_Trans2	360-V/27.6-kV/1.6-MVA cluster transformer at Cluster 2	80.1	O	S-T	U
AB_Trans3	360-V/27.6-kV/1.6-MVA cluster transformer at Cluster 3	80.1	O	S-T	U
AB_Trans4	360-V/27.6-kV/1.6-MVA cluster transformer at Cluster 4	80.1	O	S-T	U
AB_Trans5	360-V/27.6-kV/1.6-MVA cluster transformer at Cluster 5	80.1	O	S-T	U
AB_Trans6	360-V/27.6-kV/1.6-MVA cluster transformer at Cluster 6	80.1	O	S-T	U
AB_Trans7	360-V/27.6-kV/1.6-MVA cluster transformer at Cluster 7	80.1	O	S-T	U

Notes:

1. A 5-dBA penalty is included in this table.
2. Location: Inside building (I), Outside building (O).
3. Sound Characteristics: Steady (S), Tonal (T), Impulsive (I), Quasi-Steady Impulsive (QSI).
4. Noise Control: Silencer (S), Acoustic lining (A), Barrier (B), Lagging (L), Enclosure (E), Other (O), Uncontrolled (U).

3.4 Adjacent Solar Projects

To identify the adjacent solar projects Hatch's internal database of solar projects and MOE records available in http://www.ene.gov.on.ca/environment/en/subject/renewable_energy/projects/index.htm were searched (August 10, 2012).

There are two solar projects, Martin's Meadows and Empire, located in the proximity of the Project. Noise sources from these two projects were taken into account in the study. Both projects, owned by Northland with 10-MW capacity each, are similar to the Project. Coordinates for the inverter clusters

and substation transformers were provided by Northland. All noise sources from these two project were assumed unmitigated and their coordinates as well as sound power levels used for modeling are included in Appendix B.

4. Noise Receptors and Points of Reception

The Noise Receptors used in this study were identified from the OBM and Google Earth Pro aerial imagery (August 2003) within 1-km distance from the Project Site² boundary and substation transformer, and also from visual observations of the Project Site surroundings conducted in Summer 2010. The Noise Receptors were identified in accordance with O. Reg. 359/09, and its amendment (O. Reg. 521/10).

The Noise Receptors corresponding to the vacant lots were added based on parcel information provided by First Base Solutions (Teranet Data) and located according to the requirements outlined in O. Reg. 359/09, and its amendment (O. Reg. 521/10).

The total number of Noise Receptors within a 1-km distance from the Project Site of the Abitibi Solar Project is 21, including the vacant lots. Noise Receptors were represented in the CADNA-A computer model by Points of Reception (POR) according to the following rules:

- 1) existing Noise Receptors located in the immediate proximity to the Abitibi Solar Project Site were represented by building footprints with a POR located at the point on the façade where sound pressure level is maximum at 4.5-m above ground height
- 2) existing Noise Receptors located in the immediate proximity to the Abitibi Solar Project Site were also represented by envelopes extended 30 m from the building footprints and trimmed by property lines with a POR located at the point on the envelope where sound pressure level is maximum at 1.5-m above ground height
- 3) existing and vacant lot Noise Receptors located further away from the Abitibi Solar Project Site were represented by a POR placed at the center of building footprint elevated 4.5 m above ground
- 4) existing and vacant lot Noise Receptors located further away from the Abitibi Solar Project Site were also represented by a POR located within 30-m distance measured from the POR position as defined in Item 3) where sound pressure level is max at 1.5 m above ground height.

Six of the POR, identified in Table 4.1 and Table 4.2, were chosen as representative POR for evaluating the noise contribution from each individual source. These POR were chosen in order to represent sound pressure level contributions on different areas around the Project Location. The complete set of results for all POR used to model 21 Noise Receptors is provided in Table 7.1 while a list containing coordinates of building footprint centers for all 50 Noise Receptors located within 1 km from any of the considered solar projects is available in Table C.1 of Appendix C.

²“Project Site” in the context of this study is the complete area designated for the Project, but not necessarily occupied with the project infrastructure. Project Location is always contained within Project Site.

Table 4.1 1.5-m Case – Point of Reception Noise Impact from Individual Noise Sources of Abitibi Solar Project

Source ID	Noise Receptor ID					
	R36		R42		R47	
	Dist [m]	Sound Pressure Contribution [dBA]	Dist [m]	Sound Pressure Contribution [dBA]	Dist [m]	Sound Pressure Contribution [dBA]
Ab_Sub115	125.5	33.2	806.1	15.2	1184.6	10.9
Ab_Inv1	1255.9	13.1	896.8	16.8	1064.9	14.9
Ab_Inv2	1119.6	14.4	717.6	19.2	899.3	16.8
Ab_Inv3	996.8	15.7	538.4	22.2	740.0	18.9
Ab_Inv4	893.5	16.9	359.2	26.2	592.1	21.2
Ab_Inv5	1423.6	11.6	803.9	18.0	787.1	18.2
Ab_Inv6	1328.7	12.4	649.3	20.3	597.2	21.1
Ab_Inv7	1255.0	13.1	517.9	22.6	405.7	25.0
Ab_Trans1	1259.7	2.1	897.3	6.0	1063.5	4.1
Ab_Trans2	1123.7	3.5	718.1	8.5	897.4	6.0
Ab_Trans3	1001.4	4.8	538.9	11.5	737.7	8.2
Ab_Trans4	898.5	6.0	359.8	15.6	589.1	10.6
Ab_Trans5	1418.7	0.7	800.6	7.3	786.3	7.5
Ab_Trans6	1323.5	1.6	645.4	9.6	596.3	10.4
Ab_Trans7	1249.6	2.2	513.2	12.0	404.6	14.4

Table 4.2 4.5-m Case – Point of Reception Noise Impact from Individual Noise Sources of Abitibi Solar Project

Source ID	Noise Receptor ID					
	R36		R42		R47	
	Dist [m]	Sound Pressure Contribution [dBA]	Dist [m]	Sound Pressure Contribution [dBA]	Dist [m]	Sound Pressure Contribution [dBA]
Ab Sub115	154.7	33.1	785.4	17.8	1198.2	13.2
Ab Inv1	1267.0	15.5	927.3	18.9	1094.9	17.1
Ab Inv2	1128.0	16.8	748.1	21.1	929.2	18.9
Ab Inv3	1001.7	18.1	569.0	23.8	769.6	20.8
Ab Inv4	893.8	19.3	390.0	27.4	620.6	23.0
Ab Inv5	1425.1	14.2	841.2	19.9	814.7	20.2
Ab Inv6	1326.6	15.0	686.7	22.0	624.5	22.9
Ab Inv7	1248.8	15.7	553.7	24.1	432.6	26.4
Ab Trans1	1270.7	4.3	927.9	7.8	1093.5	6.0
Ab Trans2	1132.0	5.6	748.8	10.1	927.4	7.8
Ab Trans3	1006.1	6.9	569.7	12.8	767.3	9.8
Ab Trans4	898.7	8.1	390.8	16.5	617.6	12.0
Ab Trans5	1420.3	3.1	837.9	8.9	813.9	9.2
Ab Trans6	1321.5	3.9	682.7	11.0	623.7	11.9
Ab Trans7	1243.5	4.6	549.0	13.2	431.7	15.5

5. Mitigation Measures

The analysis indicates that no mitigation measures are necessary to meet the MOE requirement of 40 dBA for all POR.

6. Impact Assessment

The purpose of the acoustic Assessment report is to demonstrate that the facility is in compliance with the noise performance limits. The Project will be located in a Class 3 Area, based on the classification defined in Publication NPC-232 by the MOE. Class 3 area indicates a rural area with an acoustical environment that is dominated by natural sounds, with little or no traffic noise.

Table 6.1 shows the performance limits set by the MOE for Class 3 Areas, according to Publication NPC-232.

Table 6.1 Performance Limits (One-Hour L_{eq}) by Time of Day for Class 3 Areas

Time of Day	One Hour L_{eq} (dBA) Class 3 Area
07:00 to 19:00	45.0
19:00 to 23:00	40.0
23:00 to 07:00	40.0

The solar facility will be operating during the daylight hours, that is, between 07:00 and 19:00 during most days of the year. However, in the summer months the sun may shine before 07:00 or until past 19:00. As such, during the summer the facility will be operating at the time when the applicable performance limit changes from 45 dBA to 40 dBA. Also, the transformers remain energized at night. In order to account for this, the study assumes that the facility will be operating 24 hours and compares the impact from the facility with the 40-dBA limit. In reality, the cooling fans will not be in operation at night.

For this study, the overall ground attenuation coefficient was estimated to be 0.7. Appendix D includes a list of all the parameters used in the CADNA-A model to predict the sound pressure levels at the POR.

6.1 Compliance with Performance Limits

Table 7.1 presents the predicted sound pressure levels for the POR used to model the Noise Receptors located within 1 km from the Project Site and 115-kV substation transformer. Sound pressure contours at 4.5 m and 1.5 m are available in Figure C.1 and Figure C.2. Appendix D includes a detailed calculation log for the representative POR.

The results of this study show that all Noise Receptors are compliant with MOE guidelines based on the 40-dBA performance limit.

7. Conclusions and Recommendations

For the Abitibi Solar Project, the sound pressure levels at the POR have been estimated using the CADNA-A model, based on ISO 9613-2. It has been determined that no mitigation measures are needed for the Project operation.

Based on the results obtained in this study, it is concluded that the sound pressure levels at the Noise Receptors, resulting from the Project operation, will be below MOE requirements for Class 3 areas of 40 dBA at all time.

Blank back

Table 7.1 Calculated Sound Pressure Levels at POR used to Mode Noise Receptors within 1 km of Abitibi Solar Project

Shaded rows correspond to representative POR
Existing = Existing dwelling, Vacant = Vacant Lot.
The performance limit is 40.0 dBA.

Noise Receptor ID	Description	Point of Reception at 4.5 m								Point of Reception at 1.5 m							
		UTM Coordinates NAD 83 Zone 17 [m]		Sound Pressure [dBA]				Nearest Project Source		UTM Coordinates NAD 83 Zone 17 [m]		Sound Pressure [dBA]				Nearest Project Source	
		X	Y	Abitibi	Empire	Martins Meadow	Total	Dist[m]	ID	X	Y	Abitibi	Empire	Martins Meadow	Total	Dist[m]	ID
R24	Existing	500035.9	5443709.6	20.3	22.6	23.9	27.3	988.0	Ab_Sub115	500055.0	5443686.4	17.9	20.2	21.6	25.0	965.4	Ab_Sub115
R25	Existing	500039.9	5443690.6	20.3	22.7	24.0	27.4	980.9	Ab_Sub115	500063.6	5443672.1	18.0	20.4	21.7	25.1	954.7	Ab_Sub115
R26	Existing	500518.9	5443721.6	24.7	25.2	27.6	30.8	523.6	Ab_Sub115	500542.3	5443702.7	22.8	23.3	25.7	28.9	495.2	Ab_Sub115
R28	Existing	500530.9	5443671.6	25.0	25.7	28.1	31.3	496.5	Ab_Sub115	500558.1	5443658.8	23.2	23.8	26.2	29.4	466.9	Ab_Sub115
R31	Vacant	500805.8	5443536.2	31.4	32.6	33.7	37.4	202.8	Ab_Sub115	500835.7	5443533.9	30.8	32.2	32.7	36.8	172.9	Ab_Sub115
R32	Vacant	500808.9	5443692.3	29.7	30.1	31.4	35.2	253.5	Ab_Sub115	500830.9	5443672.0	28.8	29.4	30.2	34.3	223.6	Ab_Sub115
R34	Existing	500929.5	5443682.8	33.0	33.4	33.7	38.2	166.5	Ab_Sub115	500943.7	5443656.4	32.8	33.4	33.1	37.9	136.5	Ab_Sub115
R36	Existing	501060.4	5443682.1	33.8	32.7	33.8	38.2	154.7	Ab_Sub115	501045.0	5443656.4	33.6	32.5	33.1	37.9	125.5	Ab_Sub115
R37	Existing	501203.6	5443864.8	28.1	25.9	28.9	32.6	382.0	Ab_Sub115	501193.6	5443836.5	26.3	24.3	27.2	30.9	352.6	Ab_Sub115
R38	Existing	501289.8	5443828.6	28.3	25.4	29.0	32.6	405.6	Ab_Sub115	501278.3	5443800.9	26.4	23.8	27.2	30.8	377.8	Ab_Sub115
R39	Existing	501366.3	5443669.3	29.7	25.9	30.5	33.9	381.6	Ab_Sub115	501355.2	5443656.5	27.7	24.0	28.5	31.9	366.9	Ab_Sub115
R42	Existing	501792.2	5443590.3	32.3	22.0	27.7	33.9	390.0	Ab_Inv4	501814.4	5443560.1	30.7	19.4	25.3	32.1	359.2	Ab_Inv4
R43	Vacant	501802.8	5444102.2	26.2	19.4	23.8	28.7	901.4	Ab_Inv4	501788.7	5444075.7	24.0	17.0	21.6	26.5	875.2	Ab_Inv4
R44	Existing	501802.9	5443682.6	30.9	21.6	26.9	32.7	481.8	Ab_Inv4	501804.0	5443652.6	29.2	19.2	24.7	30.8	451.8	Ab_Inv4
R45	Existing	501884.1	5443682.5	31.1	21.1	26.3	32.7	486.5	Ab_Trans4	501868.4	5443657.0	29.3	18.7	24.2	30.7	459.3	Ab_Trans4
R46	Existing	502024.7	5443712.9	30.9	20.0	25.1	32.2	498.6	Ab_Trans7	502017.6	5443683.8	29.1	17.7	22.8	30.3	475.3	Ab_Trans7

Noise Receptor ID	Description	Point of Reception at 4.5 m								Point of Reception at 1.5 m							
		UTM Coordinates NAD 83 Zone 17 [m]		Sound Pressure [dBA]				Nearest Project Source		UTM Coordinates NAD 83 Zone 17 [m]		Sound Pressure [dBA]				Nearest Project Source	
		X	Y	Abitibi	Empire	Martins Meadow	Total	Dist[m]	ID	X	Y	Abitibi	Empire	Martins Meadow	Total	Dist[m]	ID
R47	Vacant	502197.1	5443688.8	31.1	19.2	24.0	32.1	431.7	Ab_Trans7	502186.7	5443660.7	29.5	16.7	21.7	30.3	404.6	Ab_Trans7
R48	Existing	502836.4	5443716.6	26.5	15.0	19.8	27.6	756.4	Ab_Inv7	502811.0	5443700.7	24.4	12.5	17.4	25.4	726.6	Ab_Inv7
R49	Existing	502847.7	5443597.3	27.2	15.7	20.1	28.2	700.5	Ab_Inv7	502819.7	5443586.5	25.2	13.5	17.6	26.2	670.8	Ab_Inv7
R50	Vacant	503091.1	5443721.9	24.5	11.9	18.4	25.6	973.8	Ab_Inv7	503062.9	5443711.6	22.2	9.3	15.9	23.3	944.1	Ab_Inv7
R51	Vacant	503184.9	5443528.5	24.5	11.8	18.3	25.6	987.7	Ab_Inv7	503156.6	5443518.6	22.3	9.3	15.7	23.4	957.8	Ab_Inv7

8. Signatures

Report Prepared By



Aret Basson, MEng, EIT

E-mail: abasson@hatch.ca; phone: 905-374-0701x5311

Report Reviewed and Approved By

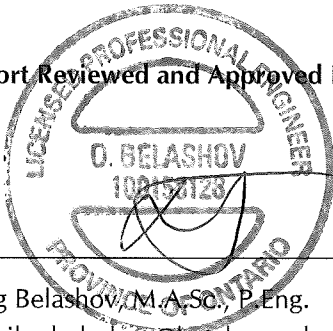

Oct 17, 2012

Oleg Belashov, M.A.Sc., P.Eng.

E-mail: obelashov@hatch.ca; phone: 905-374-0701x5269

9. References

- O. Reg. 359/09. Environmental Protection Act. Renewable Energy Approvals Under Part V.0.1 of the Act.
- O. Reg. 521/10 made under Environmental Protection Act amending O. Reg. 359/09.
- Ministry of the Environment (MOE). 2004. Basic Comprehensive Certificates of Approval (Air) – User Guide (Appendix A). Environmental Assessment and Approvals Branch.
- Robert D. Stevens; Chris Hung; TOWARD A REALISTIC ESTIMATE OF OCTAVE BAND SOUND LEVELS FOR ELECTRIC TRANSFORMERS
- Handbook of Noise and Vibration Control; Malcolm J. Crocker, 2007.
- Ministry of the Environment (MOE). 1997. Noise Assessment Criteria in Land Use Planning. Publication LU-131. Ontario Ministry of the Environment. 12 pp + Annex.
- MOE. 1995. Sound Level Limits for Stationary Sources in Class 1 & 2 Areas (Urban). Publication NPC-205. Ontario Ministry of the Environment. 6 pp + Annex.
- MOE. 1995. Sound Level Limits for Stationary Sources in Class 3 Areas (Rural). Publication NPC-232. Ontario Ministry of the Environment. 8 pp + Annex.
- NEMA. 2000. Standards Publication No. TR 1-1993 (R2000): Transformers, Regulators and Reactors. National Electrical Manufacturers Association.
- International Organization for Standardization (ISO). Standard 1996-1: Description, Measurement and Assessment of Environmental Noise – Part 1: Basic Quantities and Assessment Procedures.
- International Organization for Standardization (ISO). Standard 1913-2: Acoustics – Attenuation of sound during propagation outdoors – Part 2: General Method of Calculation.

Appendix A

**Land Use Zoning Designation Plan and
Area Location Plans**

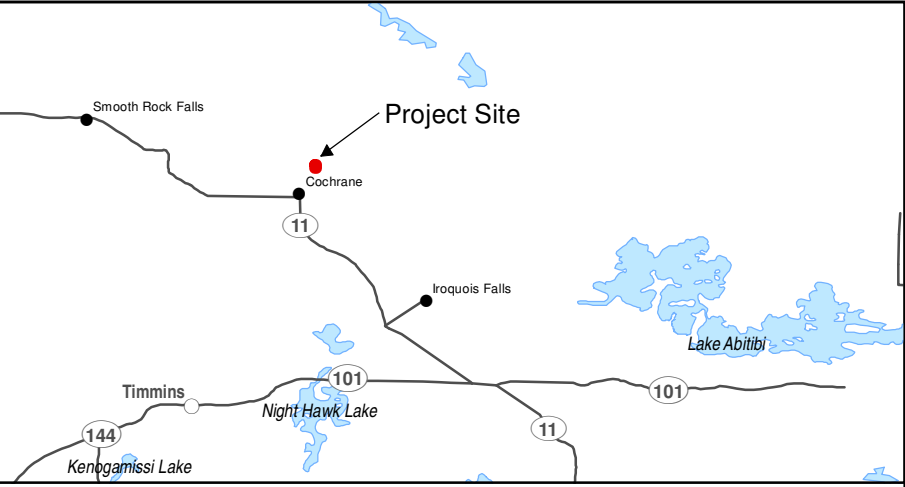
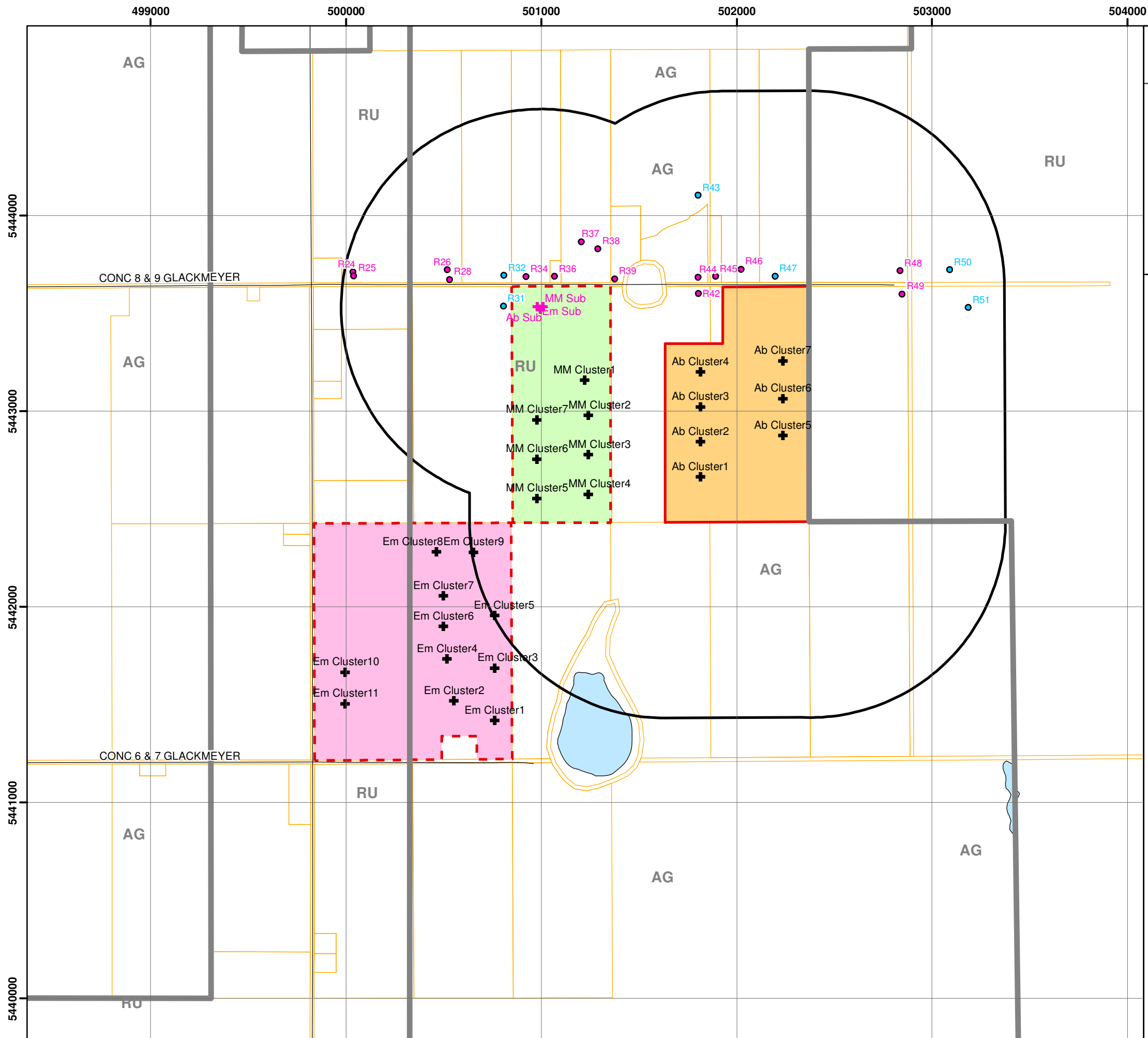

LEGEND

- Cluster#
- + Inverter Cluster
- SUB
- + Substation Transformer
- #
- # Noise Receptor - Existing
- # Noise Receptor - Vacant
- Road
- Abitibi Project Site
- Empire Project Site
- Martins Meadow Project Site
- 1000 m from Project Site
- Water Body
- Parcel
- Zoning
- AG Agricultural Area
- RU Rural Area

Notes:
 1. Produced by Hatch under licence from Ontario Ministry of Natural Resources, Copyright (c) Queens Printer 2011.
 2. Spatial referencing UTM NAD 83.



Figure A.1
 Northland Power Solar
 Abitibi L.P.
**Abitibi Solar Project
 Zoning Designation Plan**



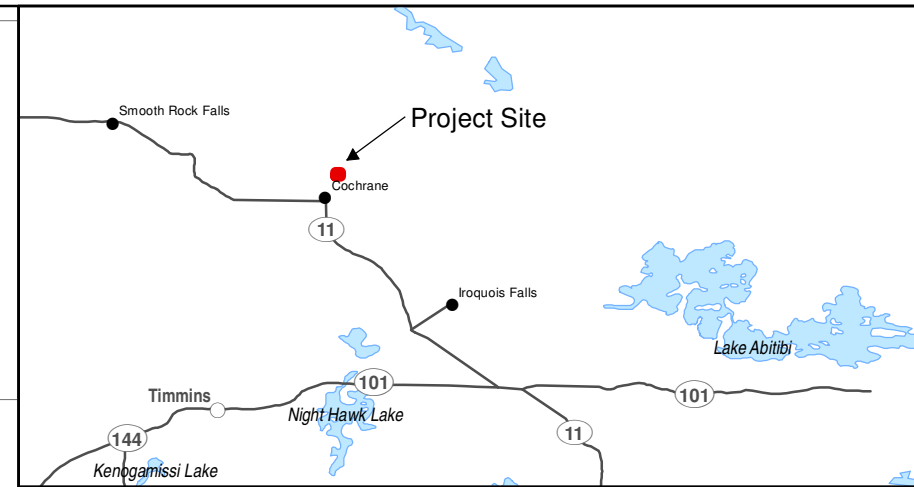
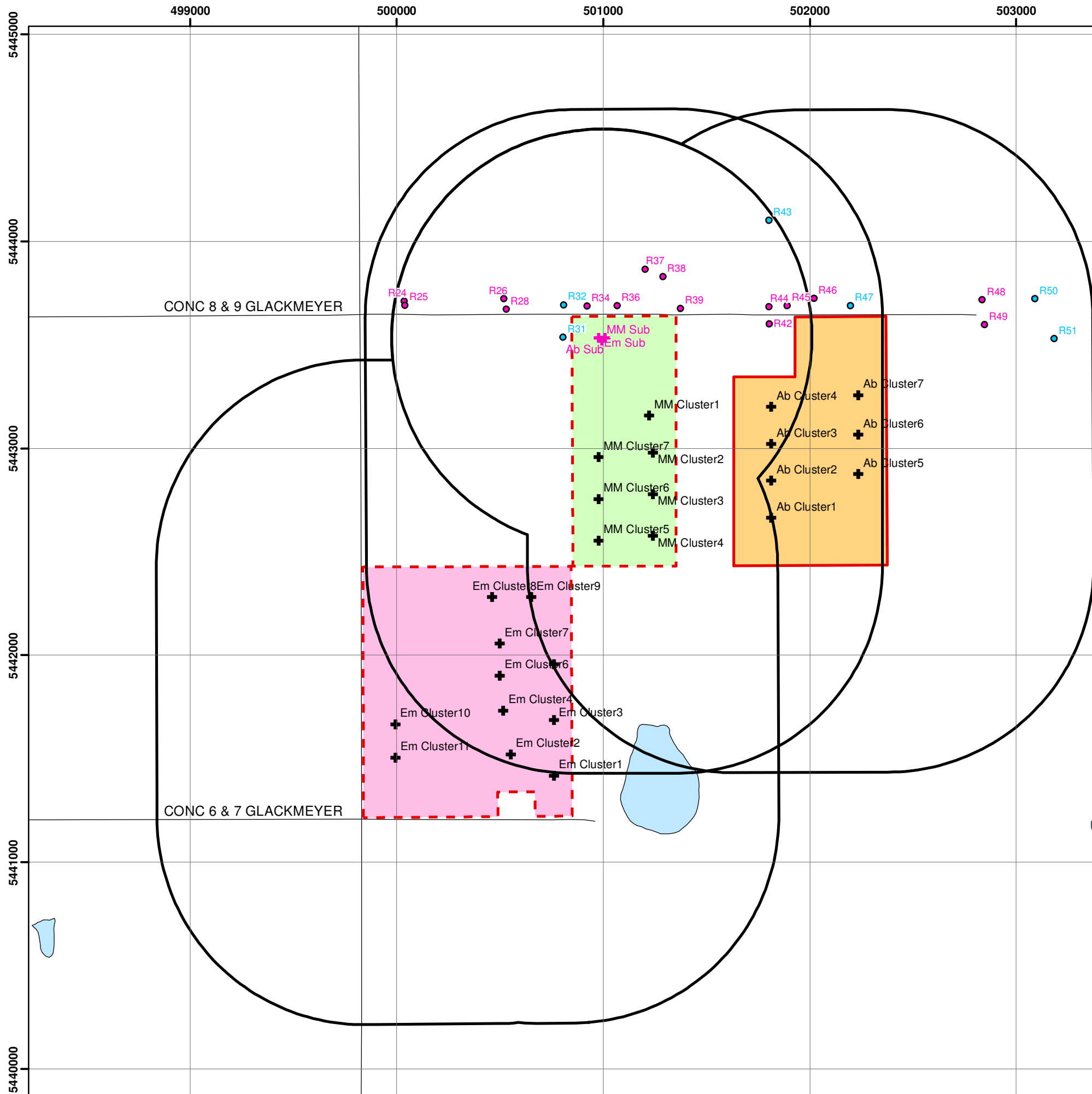

LEGEND

- Cluster #
- + Inverter Cluster
- SUB Substation Transformer
- # Noise Receptor - Existing
- # Noise Receptor - Vacant
- Road
- Abitibi Project Site
- Empire Project Site
- Martin's Meadows Project Site
- 1000 m from Project Site
- Water Body

Notes:
 1. Produced by Hatch under licence from Ontario Ministry of Natural Resources, Copyright (c) Queens Printer 2011.
 2. Spatial referencing UTM NAD 83.



Figure A.2
 Northland Power Solar
 Abitibi L.P.
Abitibi Solar Project
Scaled Area Location Plan
- Adjacent Projects



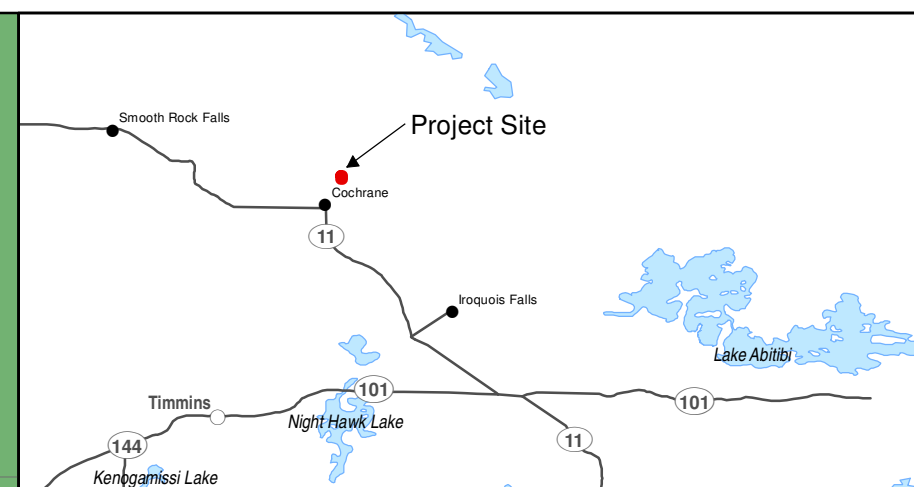
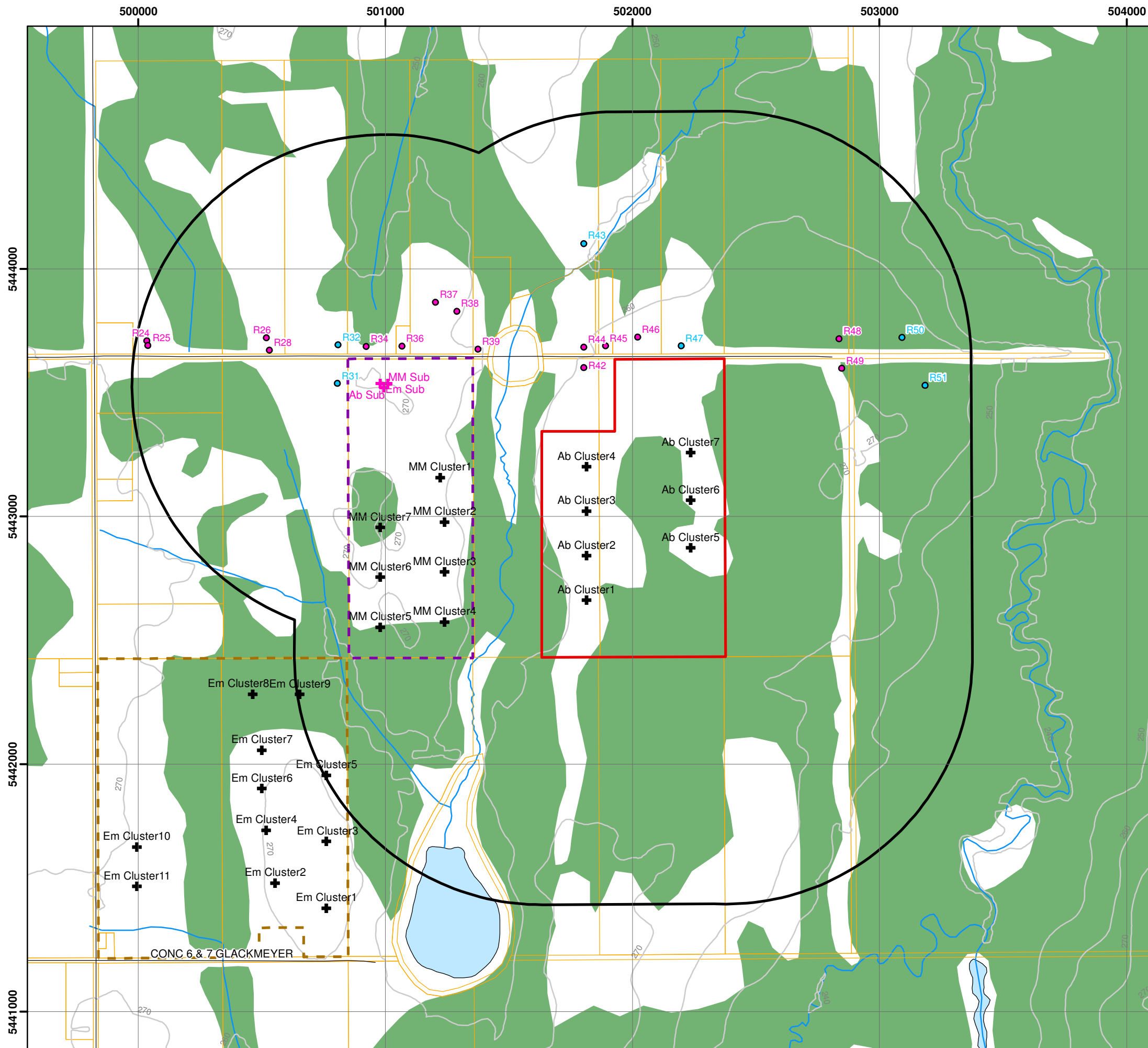

LEGEND

- Cluster#
- Cluster# + Inverter Cluster
- Cluster# + SUB Substation Transformer
- Cluster# Noise Receptor - Existing
- Cluster# Noise Receptor - Vacant
- Road
- Topographic Contour (5m interval)
- Watercourse
- Water Body
- Wooded Area
- Ab Cluster# Abitibi Project Site
- Em Cluster# Empire Project Site
- MM Cluster# Martins Meadow Project Site
- Parcel

Notes:
 1. Produced by Hatch under licence from Ontario Ministry of Natural Resources, Copyright (c) Queens Printer 2012.
 2. Spatial referencing UTM NAD 83.

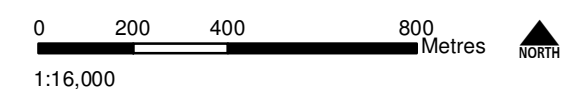

Figure A.3
 Northland Power Solar
 Abitibi L.P.
Abitibi Solar Project
Scaled Area Location Plan



Appendix B

Noise Sources

Table B.1 Point Sources from the Abitibi Solar Project Used in CADNA-A, Includes Tonality Penalty of 5.0-dBA

Source ID	Description	Spectra ID	Total sound power level (dBA)	Correction (dBA)	Height (m)	Coordinates, UTM NAD 83 Zone 17 (m)	
						X	Y
AB_Sub115	27.6-kV/115-kV/10-MVA substation transformer	T115kV_10MVA	87.9	5	3.6	501008.6	5443536.3
AB_Inv1	Two Sunny Central 800CP inverters at Cluster 1	SMA_SC800CPX2	91.3	5	2.6	501813.7	5442663.2
AB_Inv2	Two Sunny Central 800CP inverters at Cluster 2	SMA_SC800CPX2	91.3	5	2.6	501813.7	5442842.4
AB_Inv3	Two Sunny Central 800CP inverters at Cluster 3	SMA_SC800CPX2	91.3	5	2.6	501813.6	5443021.6
AB_Inv4	Two Sunny Central 800CP inverters at Cluster 4	SMA_SC800CPX2	91.3	5	2.6	501813.7	5443200.8
AB_Inv5	Two Sunny Central 800CP inverters at Cluster 5	SMA_SC800CPX2	91.3	5	2.6	502235.0	5442875.0
AB_Inv6	Two Sunny Central 800CP inverters at Cluster 6	SMA_SC800CPX2	91.3	5	2.6	502235.0	5443065.4
AB_Inv7	Two Sunny Central 800CP inverters at Cluster 7	SMA_SC800CPX2	91.3	5	2.6	502235.0	5443257.8
AB_Trans1	360-V/27.6-kV/1.6-MVA cluster transformer at Cluster 1	T27.6kV_1.6MVA	80.1	5	2.58	501819.2	5442662.7
AB_Trans2	360-V/27.6-kV/1.6-MVA cluster transformer at Cluster 2	T27.6kV_1.6MVA	80.1	5	2.58	501819.2	5442841.9
AB_Trans3	360-V/27.6-kV/1.6-MVA cluster transformer at Cluster 3	T27.6kV_1.6MVA	80.1	5	2.58	501819.1	5443021.1
AB_Trans4	360-V/27.6-kV/1.6-MVA cluster transformer at Cluster 4	T27.6kV_1.6MVA	80.1	5	2.58	501819.2	5443200.3
AB_Trans5	360-V/27.6-kV/1.6-MVA cluster transformer at Cluster 5	T27.6kV_1.6MVA	80.1	5	2.58	502229.5	5442875.5
AB_Trans6	360-V/27.6-kV/1.6-MVA cluster transformer at Cluster 6	T27.6kV_1.6MVA	80.1	5	2.58	502229.5	5443065.9
AB_Trans7	360-V/27.6-kV/1.6-MVA cluster transformer at Cluster 7	T27.6kV_1.6MVA	80.1	5	2.58	502229.5	5443258.3

Table B.2 Point Sources from Martin’s Meadows and Empire Solar Projects Used in CADNA-A, Includes Tonality Penalty of 5.0-dBA

Source ID	Description	Spectra ID	Total sound power level (dBA)	Correction (dB)	Height (m)	Coordinates, UTM NAD 83 Zone 17 (m)	
						X	Y
Em_Sub115	27.6-kV/115-kV/10-MVA substation transformer	T115kV_10MVA	87.9	5	3.6	500978.6	5443536.3
Em_Inv1	Two Sunny Central 800CP inverters at Cluster 1	SMA_SC800CPX2	91.3	5	2.6	500760.5	5441418.4
Em_Inv2	Two Sunny Central 800CP inverters at Cluster 2	SMA_SC800CPX2	91.3	5	2.6	500552.4	5441520.2
Em_Inv3	Two Sunny Central 800CP inverters at Cluster 3	SMA_SC800CPX2	91.3	5	2.6	500760.5	5441687.2
Em_Inv4	Two Sunny Central 800CP inverters at Cluster 4	SMA_SC800CPX2	91.3	5	2.6	500516.2	5441733.0
Em_Inv5	Two Sunny Central 800CP inverters at Cluster 5	SMA_SC800CPX2	91.3	5	2.6	500760.5	5441956.0
Em_Inv6	Two Sunny Central 800CP inverters at Cluster 6	SMA_SC800CPX2	91.3	5	2.6	500498.1	5441901.0
Em_Inv7	Two Sunny Central 800CP inverters at Cluster 7	SMA_SC800CPX2	91.3	5	2.6	500498.1	5442057.8
Em_Inv8	Two Sunny Central 800CP inverters at Cluster 8	SMA_SC800CPX2	91.3	5	2.6	500461.9	5442281.8
Em_Inv9	Two Sunny Central 800CP inverters at Cluster 9	SMA_SC800CPX2	91.3	5	2.6	500651.9	5442280.8
Em_Inv10	Two Sunny Central 800CP inverters at Cluster 10	SMA_SC800CPX2	91.3	5	2.6	499992.7	5441665.8
Em_Inv11	Two Sunny Central 800CP inverters at Cluster 11	SMA_SC800CPX2	91.3	5	2.6	499992.7	5441505.7
Em_Trans1	360-V/27.6-kV/1.6-MVA cluster transformer at Cluster 1	T27.6kV_1.6MVA	80.1	5	2.58	500755.0	5441418.9
Em_Trans2	360-V/27.6-kV/1.6-MVA cluster transformer at Cluster 2	T27.6kV_1.6MVA	80.1	5	2.58	500557.9	5441519.7
Em_Trans3	360-V/27.6-kV/1.6-MVA cluster transformer at Cluster 3	T27.6kV_1.6MVA	80.1	5	2.58	500755.0	5441687.7
Em_Trans4	360-V/27.6-kV/1.6-MVA cluster transformer at Cluster 4	T27.6kV_1.6MVA	80.1	5	2.58	500521.7	5441732.5
Em_Trans5	360-V/27.6-kV/1.6-MVA cluster transformer at Cluster 5	T27.6kV_1.6MVA	80.1	5	2.58	500755.0	5441956.5
Em_Trans6	360-V/27.6-kV/1.6-MVA cluster transformer at Cluster 6	T27.6kV_1.6MVA	80.1	5	2.58	500503.6	5441900.5
Em_Trans7	360-V/27.6-kV/1.6-MVA cluster transformer at Cluster 7	T27.6kV_1.6MVA	80.1	5	2.58	500503.6	5442057.3
Em_Trans8	360-V/27.6-kV/1.6-MVA cluster transformer at Cluster 8	T27.6kV_1.6MVA	80.1	5	2.58	500467.4	5442281.3
Em_Trans9	360-V/27.6-kV/1.6-MVA cluster transformer at Cluster 9	T27.6kV_1.6MVA	80.1	5	2.58	500646.4	5442281.3
Em_Trans10	360-V/27.6-kV/1.6-MVA cluster transformer at Cluster 10	T27.6kV_1.6MVA	80.1	5	2.58	499998.2	5441665.3
Em_Trans11	360-V/27.6-kV/1.6-MVA cluster transformer at Cluster 11	T27.6kV_1.6MVA	80.1	5	2.58	499998.2	5441505.2

MM_Sub115	27.6-kV/115-kV/10-MVA substation transformer	T115kV_10MVA	87.9	5	3.6	500993.6	5443521.3
MM_Inv1	Two Sunny Central 800CP inverters at Cluster 1	SMA_SC800CPX2	91.3	5	2.6	501222.0	5443157.7
MM_Inv2	Two Sunny Central 800CP inverters at Cluster 2	SMA_SC800CPX2	91.3	5	2.6	501240.1	5442978.5
MM_Inv3	Two Sunny Central 800CP inverters at Cluster 3	SMA_SC800CPX2	91.3	5	2.6	501240.1	5442776.9
MM_Inv4	Two Sunny Central 800CP inverters at Cluster 4	SMA_SC800CPX2	91.3	5	2.6	501240.1	5442575.3
MM_Inv5	Two Sunny Central 800CP inverters at Cluster 5	SMA_SC800CPX2	91.3	5	2.6	500977.7	5442553.9
MM_Inv6	Two Sunny Central 800CP inverters at Cluster 6	SMA_SC800CPX2	91.3	5	2.6	500977.7	5442755.5
MM_Inv7	Two Sunny Central 800CP inverters at Cluster 7	SMA_SC800CPX2	91.3	5	2.6	500977.7	5442957.1
MM_Trans1	360-V/27.6-kV/1.6-MVA cluster transformer at Cluster 1	T27.6kV_1.6MVA	80.1	5	2.58	501216.5	5443158.2
MM_Trans2	360-V/27.6-kV/1.6-MVA cluster transformer at Cluster 2	T27.6kV_1.6MVA	80.1	5	2.58	501234.6	5442979.0
MM_Trans3	360-V/27.6-kV/1.6-MVA cluster transformer at Cluster 3	T27.6kV_1.6MVA	80.1	5	2.58	501234.6	5442777.4
MM_Trans4	360-V/27.6-kV/1.6-MVA cluster transformer at Cluster 4	T27.6kV_1.6MVA	80.1	5	2.58	501234.6	5442575.8
MM_Trans5	360-V/27.6-kV/1.6-MVA cluster transformer at Cluster 5	T27.6kV_1.6MVA	80.1	5	2.58	500983.2	5442553.4
MM_Trans6	360-V/27.6-kV/1.6-MVA cluster transformer at Cluster 6	T27.6kV_1.6MVA	80.1	5	2.58	500983.2	5442755.0
MM_Trans7	360-V/27.6-kV/1.6-MVA cluster transformer at Cluster 7	T27.6kV_1.6MVA	80.1	5	2.58	500983.2	5442956.6

Table B.3 Frequency Spectra Used for Modelling the Noise Sources, Not Including Tonality Penalty

Spectra ID	Octave Spectrum (dBA)										
	31.5	63	125	250	500	1000	2000	4000	8000	A	lin
SMA_SC800CPX2		63.1	73.9	80.5	82.3	78.7	74.1	65.0	72.7	86.3	95.0
T27.6kV_1.6MVA	32.3	51.5	63.6	66.1	71.5	68.7	64.9	59.7	50.6	75.1	83.7
T115kV_10MVA*	38.3	55.5	68.6	74.1	79.5	76.7	72.9	67.7	57.6	82.9	89.7

*5dB was subtracted from each estimated frequency of NEMA based calculation available in Figure B.3. Northland is committed to obtain a transformer that will not exceed sound power level provided in this table.

Table B. 4 Individual Inverter Coordinates for Abitibi Solar Project

Note: Modeled noise source representing inverter cluster uses a central location of the cluster.
This table provides central points of individual inverters found within the same cluster.

Inverter ID	Description	Sound Power Level (dBA)	UTM Coordinates NAD 83 Zone 17 [m]	
			X	Y
Ab_Inv1.1	Sunny Central 800CP inverter at Cluster 1	83.3	501812.88	5442664.36
Ab_Inv1.2	Sunny Central 800CP inverter at Cluster 1	83.3	501814.48	5442662.12
Ab_Inv2.1	Sunny Central 800CP inverter at Cluster 2	83.3	501812.88	5442843.56
Ab_Inv2.2	Sunny Central 800CP inverter at Cluster 2	83.3	501814.48	5442841.32
Ab_Inv3.1	Sunny Central 800CP inverter at Cluster 3	83.3	501812.78	5443022.76
Ab_Inv3.2	Sunny Central 800CP inverter at Cluster 3	83.3	501814.38	5443020.52
Ab_Inv4.1	Sunny Central 800CP inverter at Cluster 4	83.3	501812.88	5443201.96
Ab_Inv4.2	Sunny Central 800CP inverter at Cluster 4	83.3	501814.48	5443199.72
Ab_Inv5.1	Sunny Central 800CP inverter at Cluster 5	83.3	502235.81	5442873.92
Ab_Inv5.2	Sunny Central 800CP inverter at Cluster 5	83.3	502234.21	5442876.16
Ab_Inv6.1	Sunny Central 800CP inverter at Cluster 6	83.3	502235.81	5443064.32
Ab_Inv6.2	Sunny Central 800CP inverter at Cluster 6	83.3	502234.21	5443066.56
Ab_Inv7.1	Sunny Central 800CP inverter at Cluster 7	83.3	502235.81	5443256.72
Ab_Inv7.2	Sunny Central 800CP inverter at Cluster 7	83.3	502234.21	5443258.96

SUNNY CENTRAL 720CP / 760CP / 800CP

SC 720CP-10 / SC 760CP-10 / SC 800CP-10



Economic

- Direct deployment in the field due to outdoor enclosure
- Simplified shipping without concrete substation

Efficient

- Full nominal power at ambient temperatures up to 50 °C
- 10 % additional power for constant operation at ambient temperatures up to 25 °C

Flexible

- Powerful grid management functions (including LVRT)
- DC voltage range configurable

Reliable

- Easy and safe installation due to a separate connection area
- Optional: extended input voltage range up to 1,100 V

SUNNY CENTRAL 720CP / 760CP / 800CP

High performance as standard

The completely new design of the Sunny Central CP series saves you real money. The compact and weatherproof enclosure is easy to load and transport and can be installed almost anywhere – there is no need for heavy protective concrete substations any longer. The innovative cooling concept OptiCool allows it to operate at full nominal power with ambient temperatures up to 50 °C. With the powerful grid management functions you are perfectly prepared for today's utility requirements as well as those still to come. The intelligent power management is the most important feature: in continuous operation, the Sunny Central 800CP can feed 880 kVA to the grid at ambient temperatures of up to 25 °C – that's 10 % more than the rated nominal power.

Technical data	Sunny Central 720CP	Sunny Central 760CP	Sunny Central 800CP
Input Data			
MPP voltage range	515 V – 820 V ^{3) 5)}	545 V – 820 V ^{3) 5)}	570 V – 820 V ^{3) 5)}
Max. DC voltage	1000 V / 1100 V ¹⁾ Optional		
Max. DC current	1400 A	1400 A	1400 A
Number of DC inputs	9 fused inputs		
Output Values			
Nominal AC output @ 50 °C	720 kVA	760 kVA	800 kVA
Continuous AC power @ 25 °C	792 kVA	836 kVA	880 kVA
Max. AC current	1411 A	1411 A	1411 A
Nominal AC-current	1283 A	1283 A	1283 A
Nominal AC-voltage ±10 %	324 V	342 V	360 V
AC grid frequency 50 Hz	●	●	●
AC grid frequency 60 Hz	●	●	●
Power factor (cos φ)	0.9 leading ... 0.9 lagging		
Max. THD	< 3 %	< 3 %	< 3 %
Power consumption			
Internal consumption in operation	< 1500 W ⁴⁾	< 1500 W ⁴⁾	< 1500 W ⁴⁾
Standby consumption	< 100 W	< 100 W	< 100 W
External auxiliary voltage	3 x 230 V, 50 / 60 Hz	3 x 230 V, 50 / 60 Hz	3 x 230 V, 50 / 60 Hz
Dimensions and Weight			
Dimensions (W / H / D) in mm	2562 / 2279 / 956	2562 / 2279 / 956	2562 / 2279 / 956
Weight	1800 kg	1800 kg	1800 kg
Efficiency ²⁾			
Max. efficiency	98.6 %	98.6 %	98.6 %
Euro ETA	98.4 %	98.4 %	98.4 %
CEC-eta	98.4 %	98.4 %	98.4 %
Protection Rating and Ambient Conditions			
Protection rating (as per IEC 60529)	IP54	IP54	IP54
Protection rating (as per IEC 60721-3-3)	<ul style="list-style-type: none"> • Classification of chemically active substances: 3C2 • Classification of mechanically active substances: 3S2 		
Ambient conditions: fixed location, with protection against wind and weather			
Operation temperature range	-20 °C ... +50 °C	-20 °C ... +50 °C	-20 °C ... +50 °C
Rel. humidity	15 % ... 95 %	15 % ... 95 %	15 % ... 95 %
Fresh air consumption	3000 m ³ /h	3000 m ³ /h	3000 m ³ /h
Max. altitude above sea level	2000 m	2000 m	2000 m

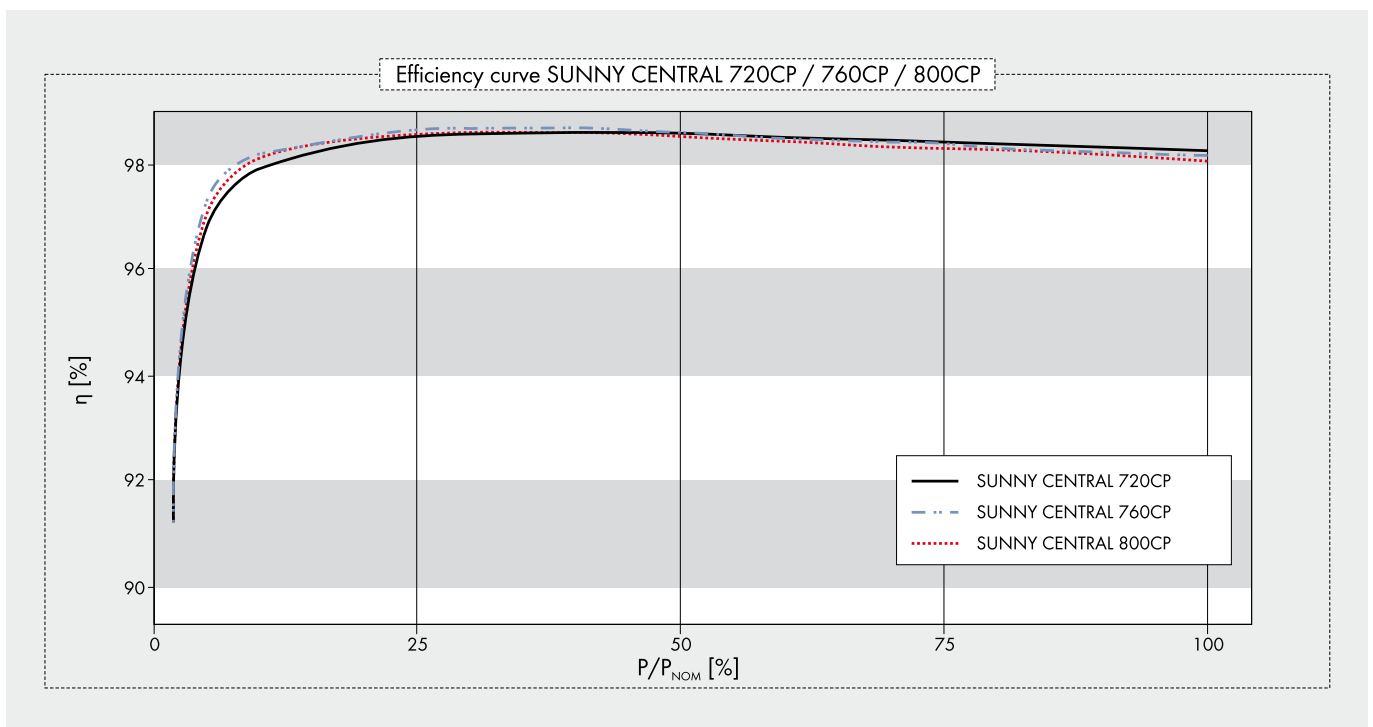

	Sunny Central 720CP	Sunny Central 760CP	Sunny Central 800CP
Features			
Sunny WebBox	●	●	●
Communication	Ethernet (optical fiber optional)	Ethernet (optical fiber optional)	Ethernet (optical fiber optional)
Communication with Sunny String-Monitor	RS485	RS485	RS485
LCD graphic display	●	●	●
Enclosure color	RAL 9016	RAL 9016	RAL 9016
Color of base	RAL 7005	RAL 7005	RAL 7005
Color of roof	RAL 7004	RAL 7004	RAL 7004
Ground fault monitoring / insulation monitoring	●	●	●
Circuit breaker AC side	●	●	●
Motor driven load disconnection switch on DC side	●	●	●
AC overvoltage protector	●	●	●
DC overvoltage protector	●	●	●
Overvoltage protectors for auxiliary supply	●	●	●
Certificates / Listings			
EMC		EN 61000-6-2 EN 61000-6-4	
CE conformity	●	●	●
BDEW-MSRL / FGW / TR8 ⁶⁾	●	●	●
RD 1633 / 2000	●	●	●
Arrêté du 23 / 04 / 08	●	●	●
● Standard features ○ Optional features – Not available			
Type name	SC 720CP-10	SC 760CP-10	SC 800CP-10

- 1) Startup at DC voltage < 1000 V
- 2) Efficiency measured without internal power supply
- 3) Further AC voltages, DC voltages and power classes can be configured (For detailed information see Technical Information „Innovations_CP“ at www.SMA.de)
- 4) Internal consumption at nominal power
- 5) At $1.05 U_{AC,nom}$ and $\cos \varphi = 1$
- 6) With complete dynamic grid support

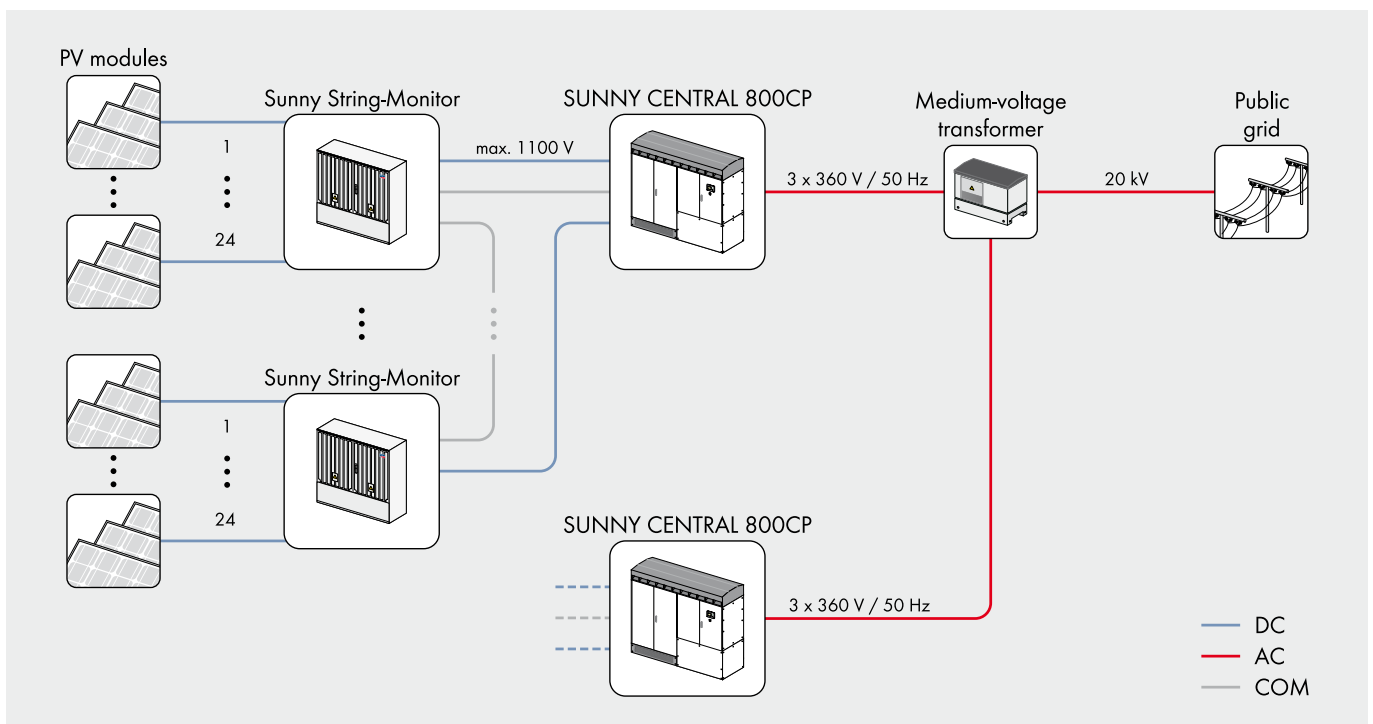

POWERFUL GRID MANAGEMENT FUNCTIONS

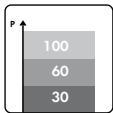

Remote controlled power reduction in case of grid overload

In order to avoid short-term grid overload, the grid operator presets a nominal active power value which the inverter will implement within 60 seconds. The nominal value is transmitted to the inverters via a ripple control receiver in combination with the SMA Power Reducer Box. Typical limit values are 100, 60, 30 or 0 per cent of the nominal power.

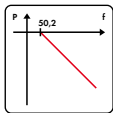

Frequency-dependent control of active power

As of a grid frequency of 50.2 Hz, the inverter automatically reduces the fed-in of active power according to a definable characteristic curve which thereby contributes to the stabilization of the grid frequency.

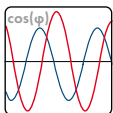

Static voltage support based on reactive power

To stabilize the grid voltage, SMA inverters feed reactive power (leading or lagging) into the grid. Three different modes are available:

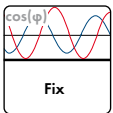

a) Fixed definition of the reactive power by the grid operator

The grid operator defines a fixed reactive power value or a fixed displacement factor between $\cos(\varphi)_{\text{leading}} = 0.90$ and $\cos(\varphi)_{\text{lagging}} = 0.90$.

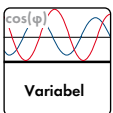

b) Definition of a dynamic setpoint of the reactive power by the utility operator

The grid operator defines a dynamic displacement factor - any value between $\cos(\varphi)_{\text{leading}} = 0.90$ und $\cos(\varphi)_{\text{lagging}} = 0.90$. It is transmitted either through a communication unit the evaluation can e.g. be evaluated and processed by the SMA Power Reducer Box.

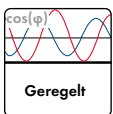

c) Control of the reactive power over a characteristic curve

The reactive power or the phase shift is controlled by a pre-defined characteristic curve - depending on the active power fed into the grid or the grid voltage.

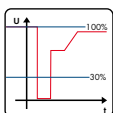

Limited Dynamic Grid Support

The inverter continues to feed to the grid after short term voltage drops - as long as the grid voltage is within a defined voltage window.

Dynamic Grid Support

LVRT (Low-Voltage Ride Through): The inverter stays connected to the grid during voltage drops and supports the grid by feeding reactive power.

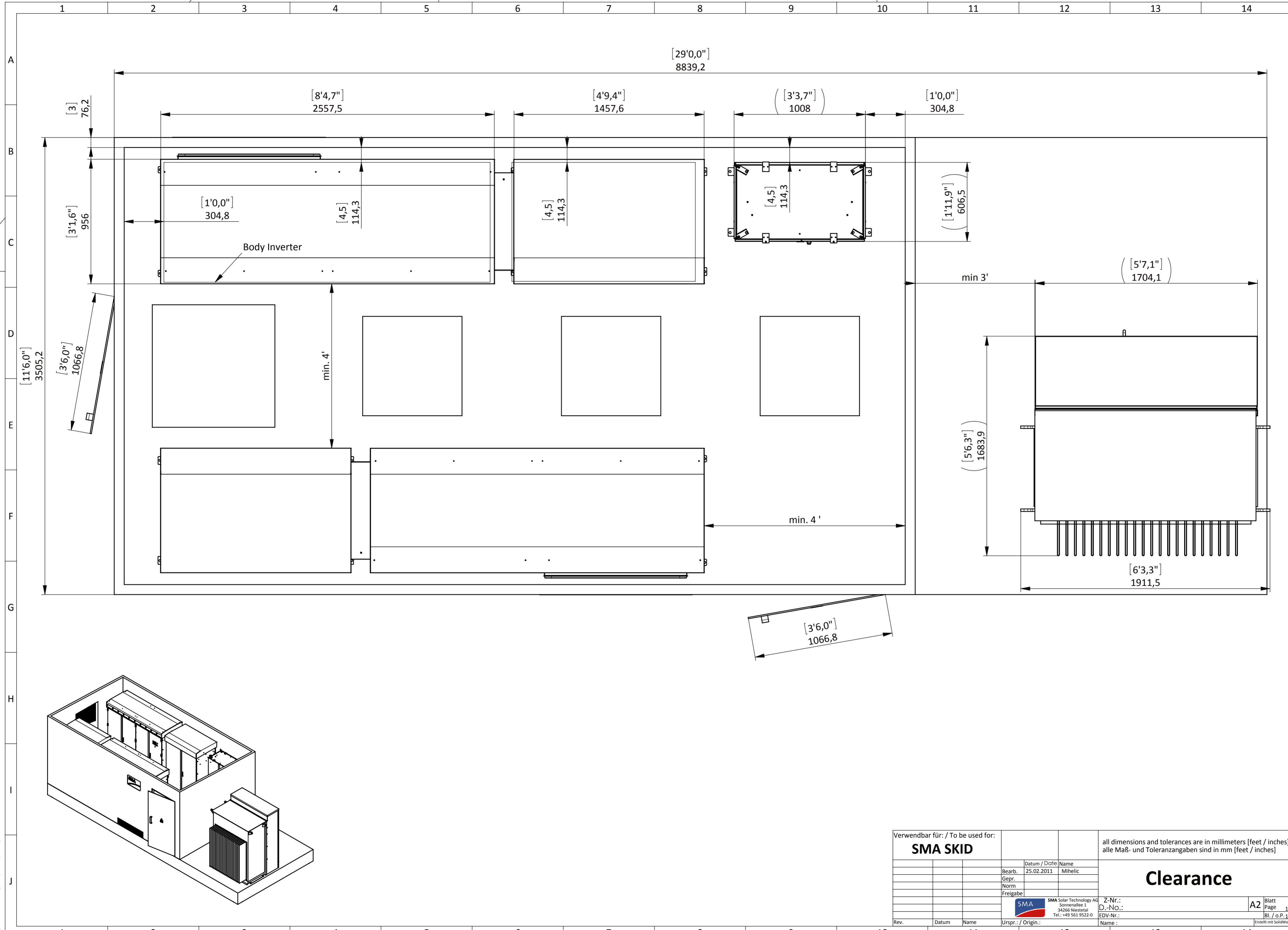

Weitergabe sowie Vervielfältigung dieses Urteils, die
 sowie auch auszudrücken, ist ausdrücklich untersagt und kann strafbar sein.
 Alle Rechte für den Fall der Patentierung oder Gebrauchsmarkeneintragung vorbehalten.
 This document may not be copied, reproduced, disseminated or otherwise used in any way without the express permission of SMA Solar Technology AG.
 Any use without the express permission of SMA Solar Technology AG is prohibited.
 All rights reserved in case of patent or patent registration.

Verwendbar für: / To be used for:			all dimensions and tolerances are in millimeters [feet / inches] alle Maß- und Toleranzangaben sind in mm [feet / inches]				
SMA SKID			<h1>Clearance</h1>				
Rev.	Datum	Name				Datum / Date	Name
						25.02.2011	Mihelic
						Gepr.	
						Norm	
			Freigabe				
			SMA Solar Technology AG Sonnenallee 1 34266 Niestetal Tel.: +49 561 9522-0		Z-Nr.: D.-No.: EDV-Nr.:		
			Urspr.: / Origin.:	Name:	A2 Blatt Page 1 Bl. / o.P. 1 <small>Erstellt mit SolidWorks</small>		

Terz-middle-frequency [kHz]	Soundpower-level L_{xpA} [dB _A]500kW	Soundpower-level L_{xpA} [dB _A]640kW	Soundpower-level L_{xpA} [dB _A]720kW	Soundpower-level L_{xpA} [dB _A]760kW	Soundpower-level L_{xpA} [dB _A]800kW
0,05	63,30	55,30	57,70	67,00	56,50
0,063	60,80	53,10	56,80	63,20	54,00
0,08	63,90	56,30	56,50	59,50	55,20
0,1	64,10	66,20	65,00	66,50	68,10
0,125	65,70	64,50	60,60	65,20	62,00
0,16	72,30	65,80	65,50	63,20	66,40
0,2	67,30	64,60	66,80	64,90	67,80
0,25	66,10	76,20	77,50	70,80	72,40
0,315	78,40	79,80	77,70	82,20	75,10
0,4	73,70	73,90	73,90	72,80	66,70
0,5	77,80	78,70	77,70	77,40	74,70
0,63	78,90	78,90	74,60	77,40	77,00
0,8	70,60	72,50	74,10	70,60	72,00
1	72,20	71,00	70,00	68,90	67,90
1,25	72,40	72,00	71,50	70,80	71,80
1,6	67,30	68,30	76,70	68,60	68,50
2	69,30	66,30	66,50	67,20	65,30
2,5	65,10	66,80	64,60	64,80	63,90
3,15	62,60	64,30	65,00	63,20	61,00
4,0	53,50	54,20	54,70	52,30	53,80
5,0	51,30	49,50	50,50	51,20	49,80
6,3	68,90	72,60	73,50	73,50	69,70

SC800CP at nominal power of 800 kW at 60 Hz

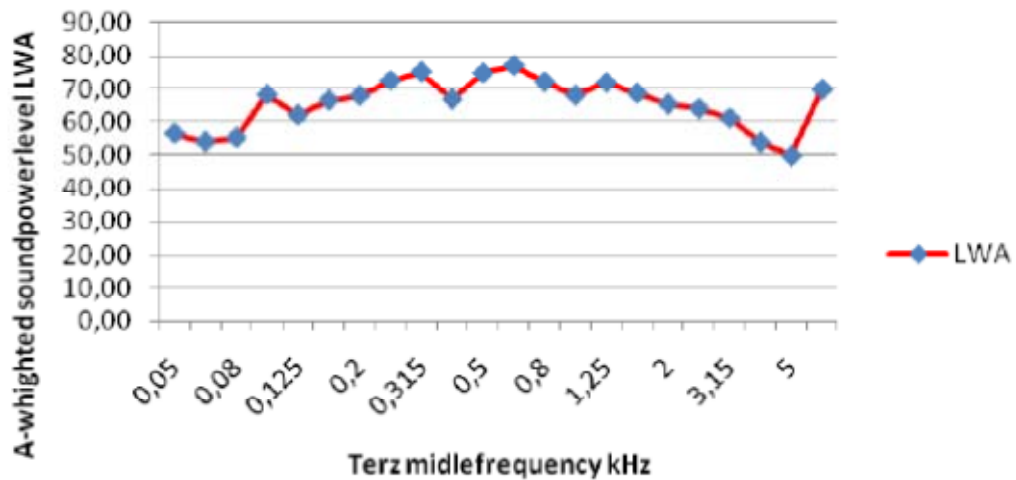

Figure B.1 SC800CP Inverter Sound Power Level as Provided by SMA. Note that the Header in the Table above Represents Various Inverter Models of CS###CP Series.

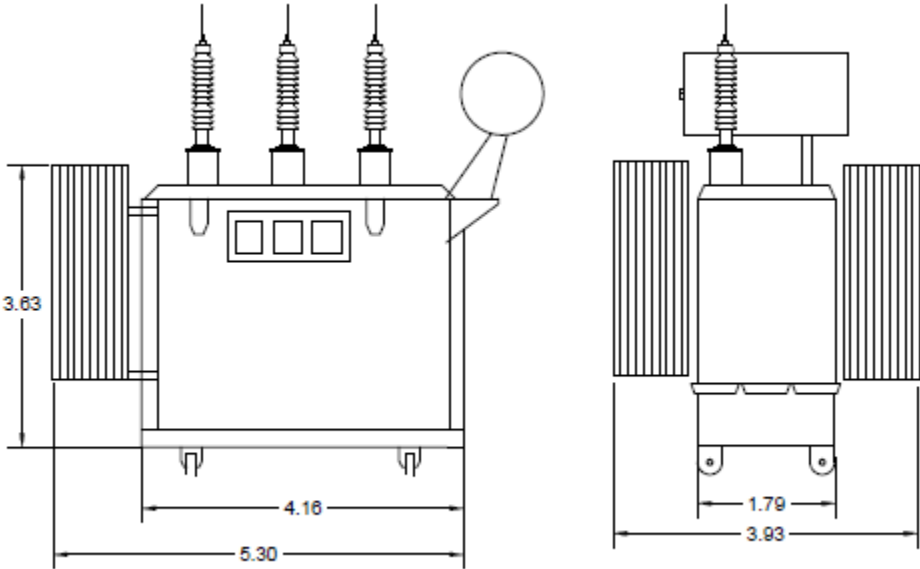

Figure B.2 115-kVA/10-MVA Substation Transformer Catalogue Dimensions (metres).

Estimated Frequency Spectra for Transformers

27.6kV/115kV/10MVA - Liquid immersed transformer

From Robert D. Stevens and Chris Hung, "Toward a realistic estimate of octave band sound levels for electrical transformers" paper

Average LpA 70.0 dBA Based on NEMA TR1-1993 (R2000), Table 0-2, immersed power transformers
 Estimated surface area 58.7 m² Estimated based on similar transformer dimensions

Correction factors to be used with meters²

Freq. [Hz]	31	63	125	250	500	1000	2000	4000	8000
Correction [dB]	-5.0	-1.0	2.0	0.0	0.0	-6.0	-11.0	-16.0	-24.0

Sound Power Level calculated as $L_w = \text{Average LpA} + 10 \cdot \log(\text{Estimated surface area in m}^2) + C$

Freq. [Hz]	31	63	125	250	500	1000	2000	4000	8000	Combined [dB]
Sound Power, Lw [dB]	82.7	86.7	89.7	87.7	87.7	81.7	76.7	71.7	63.7	94.7

Resulting A-weighted sound power level, LwA

Freq. [Hz]	31	63	125	250	500	1000	2000	4000	8000	Combined [dBA]
A-Weight [dB]	-39.4	-26.2	-16.1	-8.6	-3.2	0.0	1.2	1.0	-1.1	-
Sound Power, LwA [dBA]	43.3	60.5	73.6	79.1	84.5	81.7	77.9	72.7	62.6	87.9

Figure B.3 Sound Power Level Calculation for 27.6-kV/115-kV/10-MVA Substation Transformer.

Sound Power Level Calculation for SMA Sunny Central 800CP, 100% LOAD

Third octave, as provided		
Freq #	Freq (Hz)	LwA (dBA)
1	25	
2	31.5	
3	40	
4	50	56.5
5	63	54.0
6	80	55.2
7	100	68.1
8	125	62.0
9	160	66.4
10	200	67.8
11	250	72.4
12	315	75.1
13	400	66.7
14	500	74.7
15	630	77.0
16	800	72.0
17	1000	67.9
18	1250	71.8
19	1600	68.5
20	2000	65.3
21	2500	63.9
22	3150	61.0
23	4000	53.8
24	5000	49.8
25	6300	69.7
26	8000	
27	10000	
Total LwA		83.3

Full octave, as used in CADNA-A model			
Freq #	Freq (Hz)	LwA 1 inverter (dBA)	LwA 2 inverters (dBA)
	31.5		
5	63	60.1	63.1
8	125	70.9	73.9
11	250	77.5	80.5
14	500	79.3	82.3
17	1000	75.7	78.7
20	2000	71.1	74.1
23	4000	62.0	65.0
26	8000	69.7	72.7
Total LwA		83.3	86.3

$$10 \log \left(10^{\frac{56.5}{10}} + 10^{\frac{54.0}{10}} + 10^{\frac{55.2}{10}} \right) = 60.1 \text{ dBA}$$

$$10 \log \left(10^{\frac{60.1}{10}} + 10^{\frac{60.1}{10}} \right) = 63.1 \text{ dBA}$$

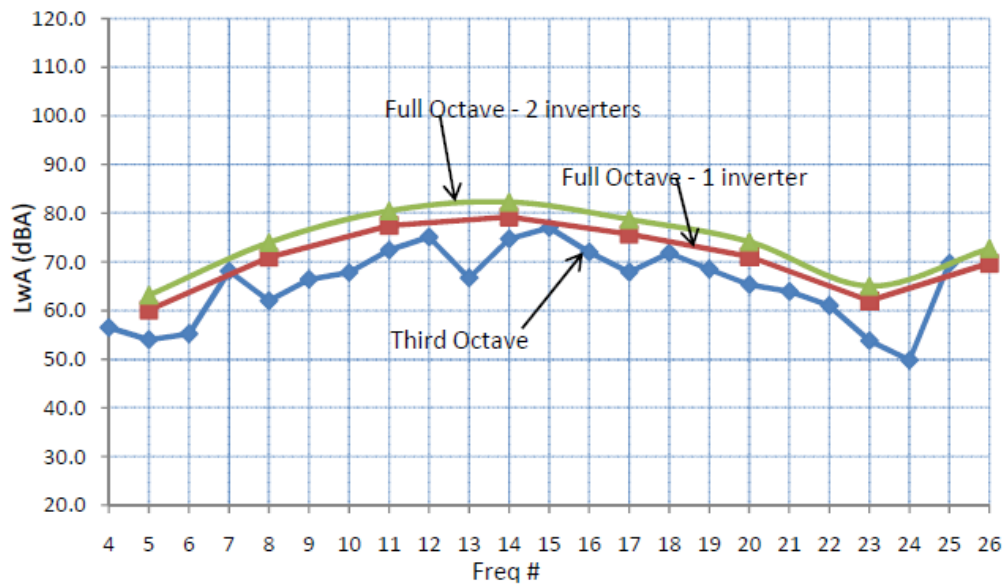

Figure B.4 Sound Power Level Calculation for SMA Sunny Central 800CP, 100% LOAD

Estimated Frequency Spectra for Transformers

Transformer - 27.6kV/1.6MVA

From Handbook of Noise and Vibration Control (Crocker, 2007, page 1335-1336, Eq. 18 and Table 20)

Average LpA 61 dBA Based on NEMA TR1-1993 (R2000), Table 0-2
 Estimated surface area 14.872 m² Estimated based on client transformer drawings

Correction factors are in dB

Freq. (Hz)	31	63	125	250	500	1000	2000	4000	8000	Notes
C1	-11.0	-5.0	-3.0	-8.0	-8.0	-14.0	-19.0	-24.0	-31.0	Outdoors, indoors in mechanical room over 140 m ³
C2	-11	-2	3	-2	-2	-11	-19	-24	-31	Indoors
C3	-11	-2	3	2	2	-4	-9	-14	-21	Serious Noise Problems

Sound Power Level calculated as $L_w = \text{Average LpA} + 10 \cdot \log(\text{Estimated surface area}) + C + 10$

Freq. (Hz)	31	63	125	250	500	1000	2000	4000	8000	Combined [dB]
C1 based [dB]	71.7	77.7	79.7	74.7	74.7	68.7	63.7	58.7	51.7	83.8
C2 based [dB]	71.7	80.7	85.7	80.7	80.7	71.7	63.7	58.7	51.7	88.8
C3 based [dB]	71.7	80.7	85.7	84.7	84.7	78.7	73.7	68.7	61.7	90.8

Resulting A-weighted sound power level

Freq. (Hz)	A-Weight	C1 based [dBA]	C2 based [dBA]	C2 based [dBA]
31	-39.4	32.3	41.3	46.3
63	-26.2	51.5	54.5	54.5
125	-16.1	63.6	69.6	69.6
250	-8.6	66.1	72.1	76.1
500	-3.2	71.5	77.5	81.5
1000	0	68.7	71.7	78.7
2000	1.2	64.9	64.9	74.9
4000	1	59.7	59.7	69.7
8000	-1.1	50.6	50.6	60.6
LwA [dBA]		75.1	80.1	84.9

 Used in the study

Figure B.5 Sound Power Level Calculation for 360-V/27.6-kV/1.6-MVA Cluster Transformer.

Appendix C

**Noise Receptor Coordinates and Noise Maps
from CADNA-A**

Table C.1 List of Building Footprint Center Coordinates for the All Noise Receptors Considered in the Study

Noise Receptor ID	Description	Coordinates, UTM NAD 83 Zone 17 (m)	
		X	Y
R01	Existing	499023.9	5441174.5
R03	Existing	499228.9	5441297.5
R04	Existing	499242.9	5441269.5
R05	Existing	499255.9	5441184.5
R06	Existing	499267.9	5441173.5
R07	Vacant	499944.9	5443685.8
R08	Vacant	499625.6	5441134.8
R09	Vacant	499742.2	5441281.4
R10	Existing	499779.4	5442915.7
R11	Existing	499787.9	5441161.5
R12	Existing	499792.9	5442321.5
R13	Existing	499792.9	5442404.5
R14	Vacant	499852.9	5441296.4
R15	Existing	499853.9	5443134.5
R16	Existing	499854.9	5443170.6
R17	Existing	499871.9	5442559.6
R18	Vacant	499886.1	5441238.3
R19	Vacant	499888.2	5440274.6
R20	Vacant	499893.4	5441141.6
R21	Existing	499893.9	5443614.6
R22	Existing	499897.2	5442882.6
R23	Existing	499897.7	5442807.0
R24	Existing	500035.9	5443709.6
R25	Existing	500039.9	5443690.6
R26	Existing	500518.9	5443721.6
R27	Existing	500522.9	5441169.5
R28	Existing	500530.9	5443671.6
R29	Existing	500556.9	5441290.5
R30	Existing	500593.9	5441256.5
R31	Vacant	500805.8	5443536.2
R32	Vacant	500808.9	5443692.3
R33	Existing	500883.9	5441175.5
R34	Existing	500922.0	5443686.3
R35	Existing	500970.9	5441293.5

Noise Receptor ID	Description	Coordinates, UTM NAD 83 Zone 17 (m)	
		X	Y
R36	Existing	501067.9	5443687.6
R37	Existing	501203.6	5443864.8
R38	Existing	501289.8	5443828.6
R39	Existing	501374.9	5443675.2
R40	Vacant	501542.2	5441105.6
R41	Vacant	501606.5	5441266.7
R42	Existing	501803.8	5443600.2
R43	Vacant	501802.8	5444102.2
R44	Existing	501802.9	5443682.6
R45	Existing	501891.4	5443688.0
R46	Existing	502021.5	5443723.9
R47	Vacant	502197.1	5443688.8
R48	Existing	502836.4	5443716.6
R49	Existing	502847.7	5443597.3
R50	Vacant	503091.1	5443721.9
R51	Vacant	503184.9	5443528.5

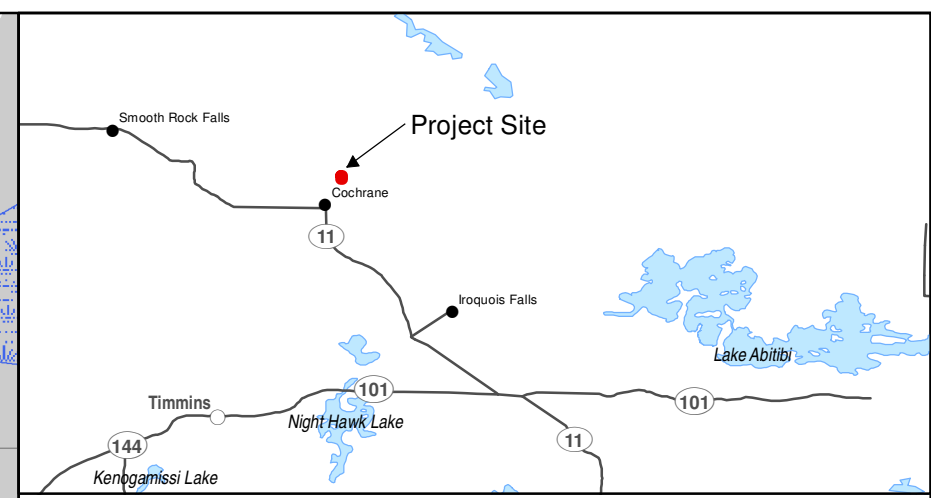

- LEGEND**
- Cluster#
 - + Inverter Cluster
 - SUB + Substation Transformer
 - # Noise Receptor - Existing
 - # Noise Receptor - Vacant
 - Road
 - ▭ Abitibi Project Site
 - ▭ Empire Project Site
 - ▭ Martins Meadow Project Site
 - ▭ Parcel
 - ▭ Water Body
 - ▭ Wetland
 - ▭ Wooded Area

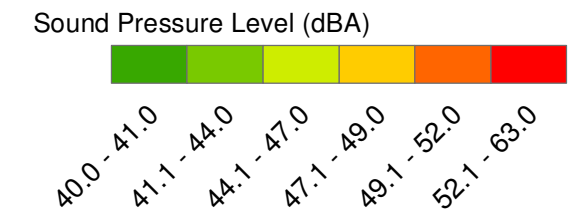

Notes:
 1. Produced by Hatch under licence from Ontario Ministry of Natural Resources, Copyright (c) Queens Printer 2011.
 2. Spatial referencing UTM NAD 83.

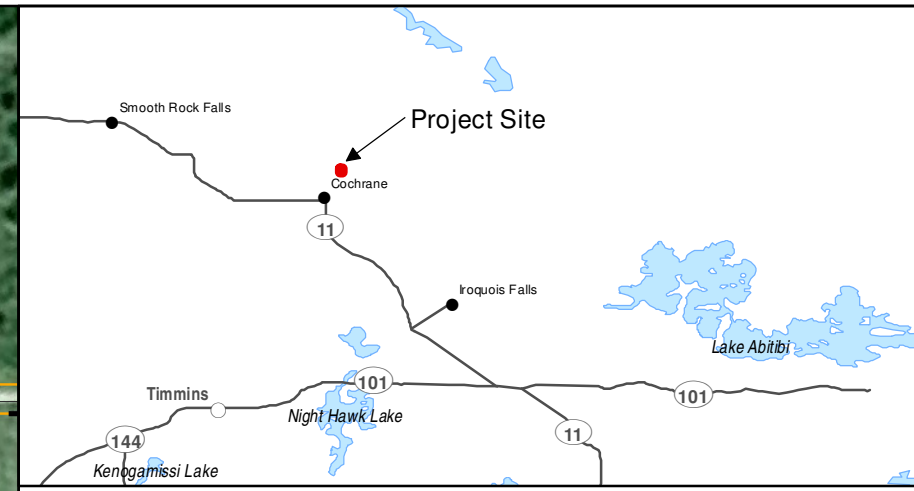
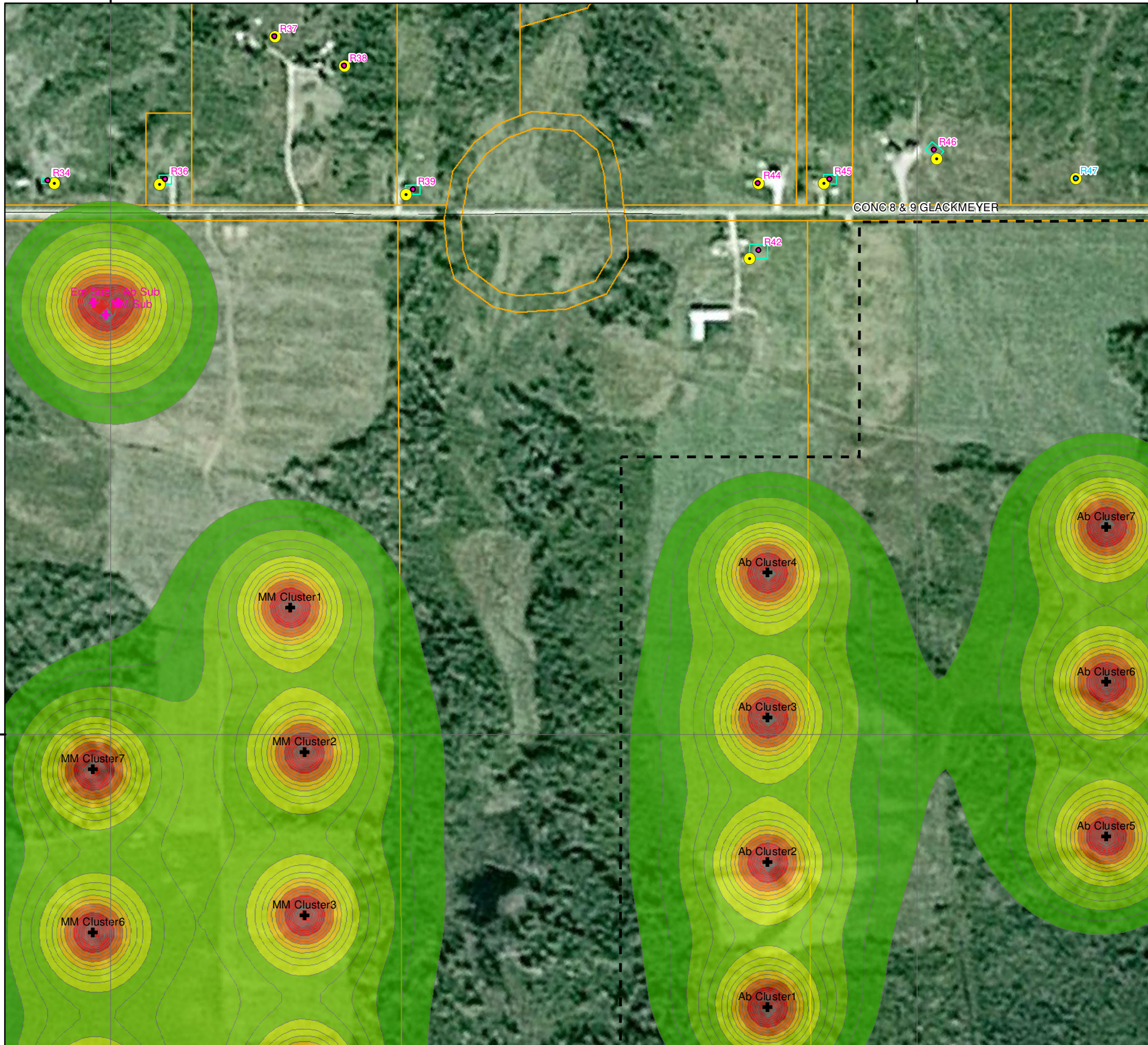

Figure C.1.1
 Northland Power Solar
 Abitibi L.P.
**Abitibi Solar Project
 Noise Contours at 4.5 m**



501000

502000



LEGEND

- Cluster#
- + Inverter Cluster
- SUB + Substation Transformer
- Noise Receptor - Existing
- # Noise Receptor - Vacant
- # Point of Reception
- Road
- Noise Receptor Footprint
- - - Abitibi Project Site
- ▭ Parcel

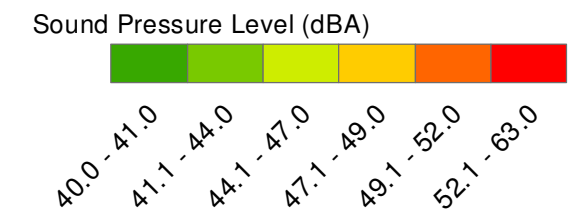

Notes:
 1. Produced by Hatch under licence from Ontario Ministry of Natural Resources, Copyright (c) Queens Printer 2011.
 2. Spatial referencing UTM NAD 83.
 3. Imagery from Google Earth Pro, dated August 2003.



Figure C.1.2
 Northland Power Solar
 Abitibi L.P.
**Abitibi Solar Project
 Noise Contours at 4.5 m**



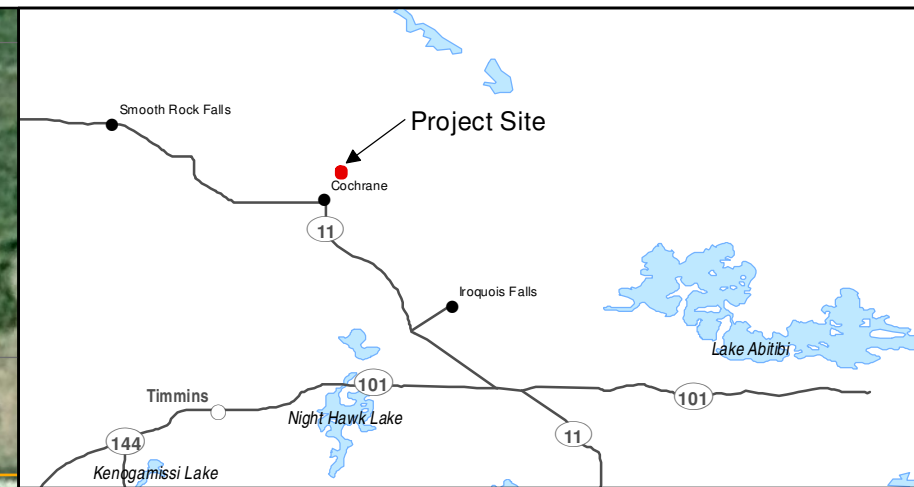
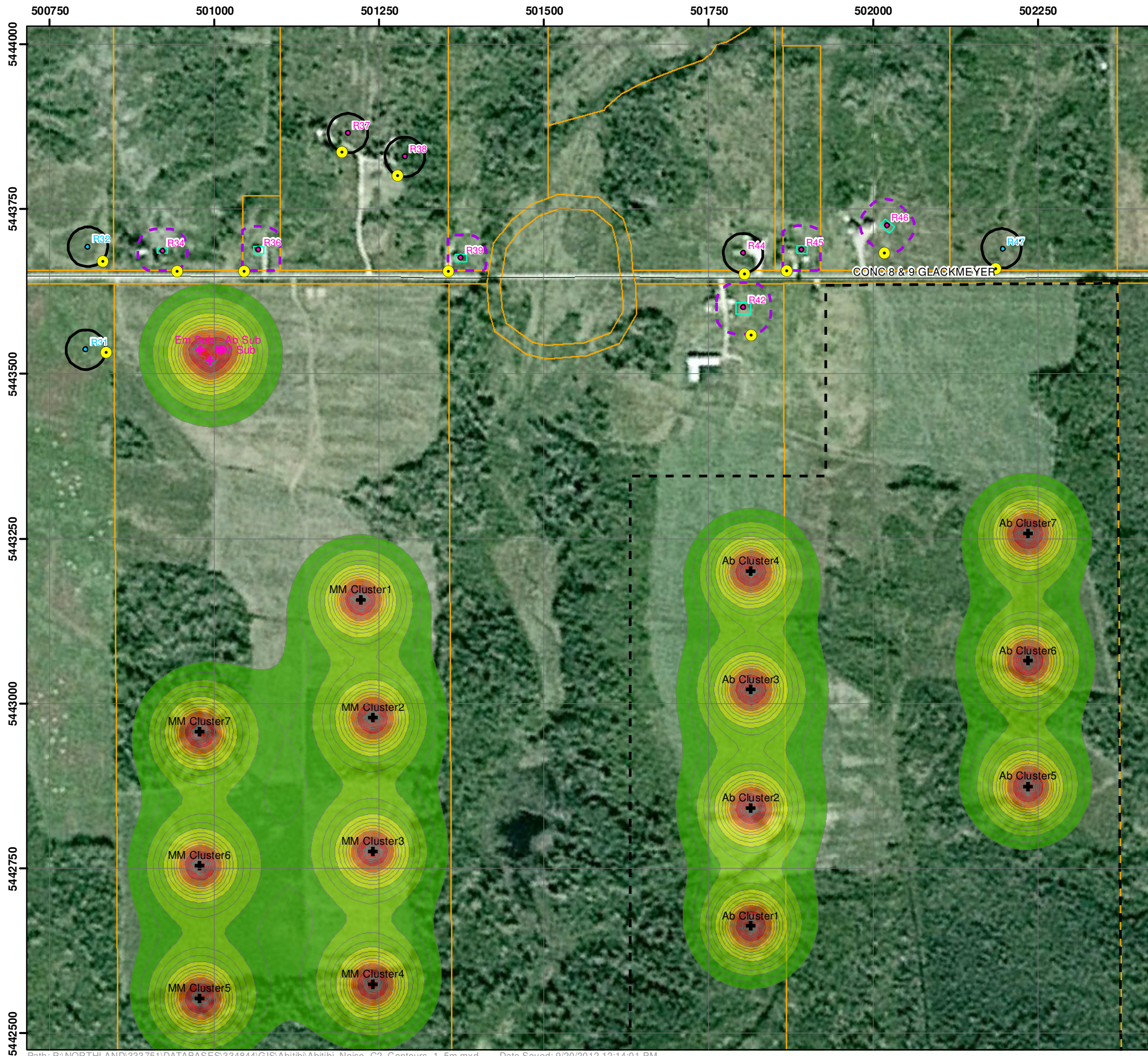

LEGEND

- Cluster#
- ⊕ Inverter Cluster
- SUB Substation Transformer
- Point of Reception
- Noise Receptor - Existing
- Noise Receptor - Vacant
- Road
- Noise Receptor Footprint
- - - 30 m from Noise Receptor Footprint
- - - Abitibi Project Site
- 30 m from Noise Receptor Centre
- Parcel

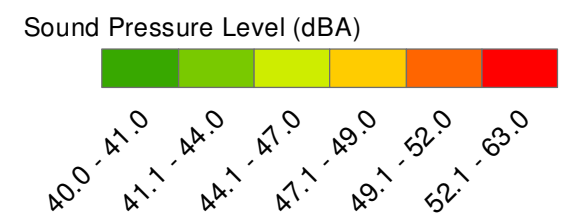

Notes:
 1. Produced by Hatch under licence from Ontario Ministry of Natural Resources, Copyright (c) Queens Printer 2011.
 2. Spatial referencing UTM NAD 83.



Figure C.2
 Northland Power Solar
 Abitibi L.P.
**Abitibi Solar Project
 Noise Contours at 1.5 m**



Appendix D

CADNA-A Sample Calculations

Configuration	
Parameter	Value
General	
Country	(user defined)
Max. Error (dB)	0.00
Max. Search Radius (m)	3000.00
Min. Dist Src to Rcvr	0.00
Partition	
Raster Factor	0.50
Max. Length of Section (m)	1000.00
Min. Length of Section (m)	1.00
Min. Length of Section (%)	0.00
Proj. Line Sources	On
Proj. Area Sources	On
Ref. Time	
Reference Time Day (min)	960.00
Reference Time Night (min)	480.00
Daytime Penalty (dB)	0.00
Recr. Time Penalty (dB)	0.00
Night-time Penalty (dB)	0.00
DTM	
Standard Height (m)	0.00
Model of Terrain	Triangulation
Reflection	
max. Order of Reflection	1
Search Radius Src	100.00
Search Radius Rcvr	100.00
Max. Distance Source - Rcvr	1000.00 1000.00
Min. Distance Rcvr - Reflector	1.00 1.00
Min. Distance Source - Reflector	0.10
Industrial (ISO 9613)	
Lateral Diffraction	some Obj
Obst. within Area Src do not shield	On
Screening	
	Excl. Ground Att. over Barrier
	Dz with limit (20/25)
Barrier Coefficients C1,2,3	3.0 20.0 0.0
Temperature (°C)	10
rel. Humidity (%)	70
Ground Absorption G	0.70
Wind Speed for Dir. (m/s)	3.0
Roads (RLS-90)	
Strictly acc. to RLS-90	
Railways (Schall 03)	
Strictly acc. to Schall 03 / Schall-Transrapid	
Aircraft (???)	
Strictly acc. to AzB	

Receiver

Name: 15_R36

ID: 15_R36

X: 501045.02

Y: 5443656.43

Z: 1.50

Point Source, ISO 9613, Name: "Ab_Sub115", ID: "Ab_Sub115"

Nr.	X (m)	Y (m)	Z (m)	Refl.	Freq. (Hz)	LxT dB(A)	LxN dB(A)	K0 (dB)	Dc (dB)	Adiv (dB)	Aatm (dB)	Agr (dB)	Afol (dB)	Ahouus (dB)	Abar (dB)	Cmet (dB)	RL (dB)	LrT dB(A)	LrN dB(A)
1	501008.63	5443536.29	3.60	0	32	43.3	43.3	0.0	0.0	53.0	0.0	-3.0	0.0	0.0	0.0	0.0	-0.0	-6.7	-6.7
2	501008.63	5443536.29	3.60	0	63	60.5	60.5	0.0	0.0	53.0	0.0	-3.0	0.0	0.0	0.0	0.0	-0.0	10.5	10.5
3	501008.63	5443536.29	3.60	0	125	73.6	73.6	0.0	0.0	53.0	0.1	1.3	0.0	0.0	0.0	0.0	-0.0	19.3	19.3
4	501008.63	5443536.29	3.60	0	250	79.1	79.1	0.0	0.0	53.0	0.1	5.3	0.0	0.0	0.0	0.0	-0.0	20.7	20.7
5	501008.63	5443536.29	3.60	0	500	84.5	84.5	0.0	0.0	53.0	0.2	2.3	0.0	0.0	0.0	0.0	-0.0	29.0	29.0
6	501008.63	5443536.29	3.60	0	1000	81.7	81.7	0.0	0.0	53.0	0.5	-0.5	0.0	0.0	0.0	0.0	-0.0	28.7	28.7
7	501008.63	5443536.29	3.60	0	2000	77.9	77.9	0.0	0.0	53.0	1.2	-0.9	0.0	0.0	0.0	0.0	-0.0	24.6	24.6
8	501008.63	5443536.29	3.60	0	4000	72.7	72.7	0.0	0.0	53.0	4.1	-0.9	0.0	0.0	0.0	0.0	-0.0	16.5	16.5
9	501008.63	5443536.29	3.60	0	8000	62.6	62.6	0.0	0.0	53.0	14.7	-0.9	0.0	0.0	0.0	0.0	-0.0	-4.1	-4.1

Point Source, ISO 9613, Name: "Ab_Inv1", ID: "Ab_Inv1"

Nr.	X (m)	Y (m)	Z (m)	Refl.	Freq. (Hz)	LxT dB(A)	LxN dB(A)	K0 (dB)	Dc (dB)	Adiv (dB)	Aatm (dB)	Agr (dB)	Afol (dB)	Ahouus (dB)	Abar (dB)	Cmet (dB)	RL (dB)	LrT dB(A)	LrN dB(A)
1	501813.68	5442663.24	2.60	0	63	68.1	68.1	0.0	0.0	73.0	0.2	-5.7	0.0	0.0	0.0	0.0	-0.0	0.7	0.7
2	501813.68	5442663.24	2.60	0	125	78.9	78.9	0.0	0.0	73.0	0.5	5.2	0.0	0.0	0.0	0.0	-0.0	0.2	0.2
3	501813.68	5442663.24	2.60	0	250	85.5	85.5	0.0	0.0	73.0	1.3	6.5	0.0	0.0	0.0	0.0	-0.0	4.7	4.7
4	501813.68	5442663.24	2.60	0	500	87.3	87.3	0.0	0.0	73.0	2.4	2.2	0.0	0.0	0.0	0.0	-0.0	9.7	9.7
5	501813.68	5442663.24	2.60	0	1000	83.7	83.7	0.0	0.0	73.0	4.6	-1.2	0.0	0.0	0.0	0.0	-0.0	7.4	7.4
6	501813.68	5442663.24	2.60	0	2000	79.1	79.1	0.0	0.0	73.0	12.1	-1.7	0.0	0.0	0.0	0.0	-0.0	-4.3	-4.3
7	501813.68	5442663.24	2.60	0	4000	70.0	70.0	0.0	0.0	73.0	41.2	-1.7	0.0	0.0	0.0	0.0	-0.0	-42.4	-42.4
8	501813.68	5442663.24	2.60	0	8000	77.7	77.7	0.0	0.0	73.0	146.8	-1.7	0.0	0.0	0.0	0.0	-0.0	-140.4	-140.4

Point Source, ISO 9613, Name: "Ab_Inv2", ID: "Ab_Inv2"

Nr.	X (m)	Y (m)	Z (m)	Refl.	Freq. (Hz)	LxT dB(A)	LxN dB(A)	K0 (dB)	Dc (dB)	Adiv (dB)	Aatm (dB)	Agr (dB)	Afol (dB)	Ahouus (dB)	Abar (dB)	Cmet (dB)	RL (dB)	LrT dB(A)	LrN dB(A)
1	501813.68	5442842.44	2.60	0	63	68.1	68.1	0.0	0.0	72.0	0.1	-5.7	0.0	0.0	0.0	0.0	-0.0	1.7	1.7
2	501813.68	5442842.44	2.60	0	125	78.9	78.9	0.0	0.0	72.0	0.5	5.1	0.0	0.0	0.0	0.0	-0.0	1.4	1.4
3	501813.68	5442842.44	2.60	0	250	85.5	85.5	0.0	0.0	72.0	1.2	6.5	0.0	0.0	0.0	0.0	-0.0	5.9	5.9
4	501813.68	5442842.44	2.60	0	500	87.3	87.3	0.0	0.0	72.0	2.2	2.2	0.0	0.0	0.0	0.0	-0.0	10.9	10.9
5	501813.68	5442842.44	2.60	0	1000	83.7	83.7	0.0	0.0	72.0	4.1	-1.2	0.0	0.0	0.0	0.0	-0.0	8.9	8.9
6	501813.68	5442842.44	2.60	0	2000	79.1	79.1	0.0	0.0	72.0	10.8	-1.7	0.0	0.0	0.0	0.0	-0.0	-2.0	-2.0
7	501813.68	5442842.44	2.60	0	4000	70.0	70.0	0.0	0.0	72.0	36.7	-1.7	0.0	0.0	0.0	0.0	-0.0	-37.0	-37.0
8	501813.68	5442842.44	2.60	0	8000	77.7	77.7	0.0	0.0	72.0	130.9	-1.7	0.0	0.0	0.0	0.0	-0.0	-123.4	-123.4

Point Source, ISO 9613, Name: "Ab_Inv3", ID: "Ab_Inv3"

Nr.	X (m)	Y (m)	Z (m)	Refl.	Freq. (Hz)	LxT dB(A)	LxN dB(A)	K0 (dB)	Dc (dB)	Adiv (dB)	Aatm (dB)	Agr (dB)	Afol (dB)	Ahouus (dB)	Abar (dB)	Cmet (dB)	RL (dB)	LrT dB(A)	LrN dB(A)
1	501813.58	5443021.64	2.60	0	63	68.1	68.1	0.0	0.0	71.0	0.1	-5.6	0.0	0.0	0.0	0.0	-0.0	2.6	2.6
2	501813.58	5443021.64	2.60	0	125	78.9	78.9	0.0	0.0	71.0	0.4	4.9	0.0	0.0	0.0	0.0	-0.0	2.6	2.6
3	501813.58	5443021.64	2.60	0	250	85.5	85.5	0.0	0.0	71.0	1.0	6.5	0.0	0.0	0.0	0.0	-0.0	7.0	7.0
4	501813.58	5443021.64	2.60	0	500	87.3	87.3	0.0	0.0	71.0	1.9	2.2	0.0	0.0	0.0	0.0	-0.0	12.2	12.2
5	501813.58	5443021.64	2.60	0	1000	83.7	83.7	0.0	0.0	71.0	3.6	-1.2	0.0	0.0	0.0	0.0	-0.0	10.3	10.3
6	501813.58	5443021.64	2.60	0	2000	79.1	79.1	0.0	0.0	71.0	9.6	-1.7	0.0	0.0	0.0	0.0	-0.0	0.2	0.2
7	501813.58	5443021.64	2.60	0	4000	70.0	70.0	0.0	0.0	71.0	32.7	-1.7	0.0	0.0	0.0	0.0	-0.0	-31.9	-31.9
8	501813.58	5443021.64	2.60	0	8000	77.7	77.7	0.0	0.0	71.0	116.5	-1.7	0.0	0.0	0.0	0.0	-0.0	-108.1	-108.1

Point Source, ISO 9613, Name: "Ab_Inv4", ID: "Ab_Inv4"

Nr.	X (m)	Y (m)	Z (m)	Refl.	Freq. (Hz)	LxT dB(A)	LxN dB(A)	K0 (dB)	Dc (dB)	Adiv (dB)	Aatm (dB)	Agr (dB)	Afol (dB)	Ahouus (dB)	Abar (dB)	Cmet (dB)	RL (dB)	LrT dB(A)	LrN dB(A)
1	501813.68	5443200.84	2.60	0	63	68.1	68.1	0.0	0.0	70.0	0.1	-5.6	0.0	0.0	0.0	0.0	-0.0	3.6	3.6
2	501813.68	5443200.84	2.60	0	125	78.9	78.9	0.0	0.0	70.0	0.4	4.7	0.0	0.0	0.0	0.0	-0.0	3.8	3.8
3	501813.68	5443200.84	2.60	0	250	85.5	85.5	0.0	0.0	70.0	0.9	6.5	0.0	0.0	0.0	0.0	-0.0	8.0	8.0
4	501813.68	5443200.84	2.60	0	500	87.3	87.3	0.0	0.0	70.0	1.7	2.2	0.0	0.0	0.0	0.0	-0.0	13.3	13.3

Point Source, ISO 9613, Name: "Ab_Inv4", ID: "Ab_Inv4"																			
Nr.	X	Y	Z	Refl.	Freq.	LxT	LxN	K0	Dc	Adiv	Aatm	Agr	Afol	Ahous	Abar	Cmet	RL	LrT	LrN
	(m)	(m)	(m)		(Hz)	dB(A)	dB(A)	(dB)	(dB)	(dB)	(dB)	(dB)	(dB)	(dB)	(dB)	(dB)	(dB)	dB(A)	dB(A)
5	501813.68	5443200.84	2.60	0	1000	83.7	83.7	0.0	0.0	70.0	3.3	-1.2	0.0	0.0	0.0	0.0	-0.0	11.6	11.6
6	501813.68	5443200.84	2.60	0	2000	79.1	79.1	0.0	0.0	70.0	8.6	-1.7	0.0	0.0	0.0	0.0	-0.0	2.1	2.1
7	501813.68	5443200.84	2.60	0	4000	70.0	70.0	0.0	0.0	70.0	29.3	-1.7	0.0	0.0	0.0	0.0	-0.0	-27.6	-27.6
8	501813.68	5443200.84	2.60	0	8000	77.7	77.7	0.0	0.0	70.0	104.4	-1.7	0.0	0.0	0.0	0.0	-0.0	-95.1	-95.1

Point Source, ISO 9613, Name: "Ab_Inv5", ID: "Ab_Inv5"																			
Nr.	X	Y	Z	Refl.	Freq.	LxT	LxN	K0	Dc	Adiv	Aatm	Agr	Afol	Ahous	Abar	Cmet	RL	LrT	LrN
	(m)	(m)	(m)		(Hz)	dB(A)	dB(A)	(dB)	(dB)	(dB)	(dB)	(dB)	(dB)	(dB)	(dB)	(dB)	(dB)	dB(A)	dB(A)
1	502235.01	5442875.04	2.60	0	63	68.1	68.1	0.0	0.0	74.1	0.2	-5.7	0.0	0.0	0.0	0.0	-0.0	-0.4	-0.4
2	502235.01	5442875.04	2.60	0	125	78.9	78.9	0.0	0.0	74.1	0.6	5.2	0.0	0.0	0.0	0.0	-0.0	-1.0	-1.0
3	502235.01	5442875.04	2.60	0	250	85.5	85.5	0.0	0.0	74.1	1.5	6.5	0.0	0.0	0.0	0.0	-0.0	3.5	3.5
4	502235.01	5442875.04	2.60	0	500	87.3	87.3	0.0	0.0	74.1	2.7	2.2	0.0	0.0	0.0	0.0	-0.0	8.3	8.3
5	502235.01	5442875.04	2.60	0	1000	83.7	83.7	0.0	0.0	74.1	5.2	-1.3	0.0	0.0	0.0	0.0	-0.0	5.7	5.7
6	502235.01	5442875.04	2.60	0	2000	79.1	79.1	0.0	0.0	74.1	13.8	-1.7	0.0	0.0	0.0	0.0	-0.0	-7.0	-7.0
7	502235.01	5442875.04	2.60	0	4000	70.0	70.0	0.0	0.0	74.1	46.6	-1.7	0.0	0.0	0.0	0.0	-0.0	-49.0	-49.0
8	502235.01	5442875.04	2.60	0	8000	77.7	77.7	0.0	0.0	74.1	166.4	-1.7	0.0	0.0	0.0	0.0	-0.0	-161.0	-161.0

Point Source, ISO 9613, Name: "Ab_Inv6", ID: "Ab_Inv6"																			
Nr.	X	Y	Z	Refl.	Freq.	LxT	LxN	K0	Dc	Adiv	Aatm	Agr	Afol	Ahous	Abar	Cmet	RL	LrT	LrN
	(m)	(m)	(m)		(Hz)	dB(A)	dB(A)	(dB)	(dB)	(dB)	(dB)	(dB)	(dB)	(dB)	(dB)	(dB)	(dB)	dB(A)	dB(A)
1	502235.01	5443065.44	2.60	0	63	68.1	68.1	0.0	0.0	73.5	0.2	-5.7	0.0	0.0	0.0	0.0	-0.0	0.2	0.2
2	502235.01	5443065.44	2.60	0	125	78.9	78.9	0.0	0.0	73.5	0.6	5.2	0.0	0.0	0.0	0.0	-0.0	-0.3	-0.3
3	502235.01	5443065.44	2.60	0	250	85.5	85.5	0.0	0.0	73.5	1.4	6.5	0.0	0.0	0.0	0.0	-0.0	4.2	4.2
4	502235.01	5443065.44	2.60	0	500	87.3	87.3	0.0	0.0	73.5	2.6	2.2	0.0	0.0	0.0	0.0	-0.0	9.1	9.1
5	502235.01	5443065.44	2.60	0	1000	83.7	83.7	0.0	0.0	73.5	4.9	-1.3	0.0	0.0	0.0	0.0	-0.0	6.6	6.6
6	502235.01	5443065.44	2.60	0	2000	79.1	79.1	0.0	0.0	73.5	12.8	-1.7	0.0	0.0	0.0	0.0	-0.0	-5.5	-5.5
7	502235.01	5443065.44	2.60	0	4000	70.0	70.0	0.0	0.0	73.5	43.5	-1.7	0.0	0.0	0.0	0.0	-0.0	-45.3	-45.3
8	502235.01	5443065.44	2.60	0	8000	77.7	77.7	0.0	0.0	73.5	155.3	-1.7	0.0	0.0	0.0	0.0	-0.0	-149.4	-149.4

Point Source, ISO 9613, Name: "Ab_Inv7", ID: "Ab_Inv7"																			
Nr.	X	Y	Z	Refl.	Freq.	LxT	LxN	K0	Dc	Adiv	Aatm	Agr	Afol	Ahous	Abar	Cmet	RL	LrT	LrN
	(m)	(m)	(m)		(Hz)	dB(A)	dB(A)	(dB)	(dB)	(dB)	(dB)	(dB)	(dB)	(dB)	(dB)	(dB)	(dB)	dB(A)	dB(A)
1	502235.01	5443257.84	2.60	0	63	68.1	68.1	0.0	0.0	73.0	0.2	-5.7	0.0	0.0	0.0	0.0	-0.0	0.7	0.7
2	502235.01	5443257.84	2.60	0	125	78.9	78.9	0.0	0.0	73.0	0.5	5.2	0.0	0.0	0.0	0.0	-0.0	0.2	0.2
3	502235.01	5443257.84	2.60	0	250	85.5	85.5	0.0	0.0	73.0	1.3	6.5	0.0	0.0	0.0	0.0	-0.0	4.7	4.7
4	502235.01	5443257.84	2.60	0	500	87.3	87.3	0.0	0.0	73.0	2.4	2.2	0.0	0.0	0.0	0.0	-0.0	9.7	9.7
5	502235.01	5443257.84	2.60	0	1000	83.7	83.7	0.0	0.0	73.0	4.6	-1.2	0.0	0.0	0.0	0.0	-0.0	7.4	7.4
6	502235.01	5443257.84	2.60	0	2000	79.1	79.1	0.0	0.0	73.0	12.1	-1.7	0.0	0.0	0.0	0.0	-0.0	-4.3	-4.3
7	502235.01	5443257.84	2.60	0	4000	70.0	70.0	0.0	0.0	73.0	41.1	-1.7	0.0	0.0	0.0	0.0	-0.0	-42.4	-42.4
8	502235.01	5443257.84	2.60	0	8000	77.7	77.7	0.0	0.0	73.0	146.7	-1.7	0.0	0.0	0.0	0.0	-0.0	-140.2	-140.2

Point Source, ISO 9613, Name: "Ab_Trans1", ID: "Ab_Trans1"																			
Nr.	X	Y	Z	Refl.	Freq.	LxT	LxN	K0	Dc	Adiv	Aatm	Agr	Afol	Ahous	Abar	Cmet	RL	LrT	LrN
	(m)	(m)	(m)		(Hz)	dB(A)	dB(A)	(dB)	(dB)	(dB)	(dB)	(dB)	(dB)	(dB)	(dB)	(dB)	(dB)	dB(A)	dB(A)
1	501819.18	5442662.74	2.58	0	32	37.3	37.3	0.0	0.0	73.0	0.0	-5.7	0.0	0.0	0.0	0.0	-0.0	-30.0	-30.0
2	501819.18	5442662.74	2.58	0	63	56.5	56.5	0.0	0.0	73.0	0.2	-5.7	0.0	0.0	0.0	0.0	-0.0	-11.0	-11.0
3	501819.18	5442662.74	2.58	0	125	68.6	68.6	0.0	0.0	73.0	0.5	5.2	0.0	0.0	0.0	0.0	-0.0	-10.1	-10.1
4	501819.18	5442662.74	2.58	0	250	71.1	71.1	0.0	0.0	73.0	1.3	6.5	0.0	0.0	0.0	0.0	-0.0	-9.7	-9.7
5	501819.18	5442662.74	2.58	0	500	76.5	76.5	0.0	0.0	73.0	2.4	2.2	0.0	0.0	0.0	0.0	-0.0	-1.2	-1.2
6	501819.18	5442662.74	2.58	0	1000	73.7	73.7	0.0	0.0	73.0	4.6	-1.2	0.0	0.0	0.0	0.0	-0.0	-2.7	-2.7
7	501819.18	5442662.74	2.58	0	2000	69.9	69.9	0.0	0.0	73.0	12.2	-1.7	0.0	0.0	0.0	0.0	-0.0	-13.6	-13.6
8	501819.18	5442662.74	2.58	0	4000	64.7	64.7	0.0	0.0	73.0	41.3	-1.7	0.0	0.0	0.0	0.0	-0.0	-47.9	-47.9
9	501819.18	5442662.74	2.58	0	8000	55.6	55.6	0.0	0.0	73.0	147.2	-1.7	0.0	0.0	0.0	0.0	-0.0	-162.9	-162.9

Point Source, ISO 9613, Name: "Ab_Trans2", ID: "Ab_Trans2"																			
Nr.	X	Y	Z	Refl.	Freq.	LxT	LxN	K0	Dc	Adiv	Aatm	Agr	Afol	Ahous	Abar	Cmet	RL	LrT	LrN
	(m)	(m)	(m)		(Hz)	dB(A)	dB(A)	(dB)	(dB)	(dB)	(dB)	(dB)	(dB)	(dB)	(dB)	(dB)	(dB)	dB(A)	dB(A)
1	501819.18	5442841.94	2.58	0	32	37.3	37.3	0.0	0.0	72.0	0.0	-5.7	0.0	0.0	0.0	0.0	-0.0	-29.1	-29.1
2	501819.18	5442841.94	2.58	0	63	56.5	56.5	0.0	0.0	72.0	0.1	-5.7	0.0	0.0	0.0	0.0	-0.0	-10.0	-10.0
3	501819.18	5442841.94	2.58	0	125	68.6	68.6	0.0	0.0	72.0	0.5	5.1	0.0	0.0	0.0	0.0	-0.0	-9.0	-9.0
4	501819.18	5442841.94	2.58	0	250	71.1	71.1	0.0	0.0	72.0	1.2	6.5	0.0	0.0	0.0	0.0	-0.0	-8.6	-8.6
5	501819.18	5442841.94	2.58	0	500	76.5	76.5	0.0	0.0	72.0	2.2	2.2	0.0	0.0	0.0	0.0	-0.0	0.1	0.1
6	501819.18	5442841.94	2.58	0	1000	73.7	73.7	0.0	0.0	72.0	4.1	-1.2	0.0	0.0	0.0	0.0	-0.0	-1.2	-1.2

Point Source, ISO 9613, Name: "Ab_Trans2", ID: "Ab_Trans2"																			
Nr.	X	Y	Z	Refl.	Freq.	LxT	LxN	K0	Dc	Adiv	Aatm	Agr	Afol	Ahous	Abar	Cmet	RL	LrT	LrN
	(m)	(m)	(m)		(Hz)	dB(A)	dB(A)	(dB)	(dB)	(dB)	(dB)	(dB)	(dB)	(dB)	(dB)	(dB)	(dB)	dB(A)	dB(A)
7	501819.18	5442841.94	2.58	0	2000	69.9	69.9	0.0	0.0	72.0	10.9	-1.7	0.0	0.0	0.0	0.0	-0.0	-11.3	-11.3
8	501819.18	5442841.94	2.58	0	4000	64.7	64.7	0.0	0.0	72.0	36.8	-1.7	0.0	0.0	0.0	0.0	-0.0	-42.4	-42.4
9	501819.18	5442841.94	2.58	0	8000	55.6	55.6	0.0	0.0	72.0	131.3	-1.7	0.0	0.0	0.0	0.0	-0.0	-146.1	-146.1

Point Source, ISO 9613, Name: "Ab_Trans3", ID: "Ab_Trans3"																			
Nr.	X	Y	Z	Refl.	Freq.	LxT	LxN	K0	Dc	Adiv	Aatm	Agr	Afol	Ahous	Abar	Cmet	RL	LrT	LrN
	(m)	(m)	(m)		(Hz)	dB(A)	dB(A)	(dB)	(dB)	(dB)	(dB)	(dB)	(dB)	(dB)	(dB)	(dB)	(dB)	dB(A)	dB(A)
1	501819.08	5443021.14	2.58	0	32	37.3	37.3	0.0	0.0	71.0	0.0	-5.6	0.0	0.0	0.0	0.0	-0.0	-28.1	-28.1
2	501819.08	5443021.14	2.58	0	63	56.5	56.5	0.0	0.0	71.0	0.1	-5.6	0.0	0.0	0.0	0.0	-0.0	-9.0	-9.0
3	501819.08	5443021.14	2.58	0	125	68.6	68.6	0.0	0.0	71.0	0.4	5.0	0.0	0.0	0.0	0.0	-0.0	-7.8	-7.8
4	501819.08	5443021.14	2.58	0	250	71.1	71.1	0.0	0.0	71.0	1.0	6.5	0.0	0.0	0.0	0.0	-0.0	-7.5	-7.5
5	501819.08	5443021.14	2.58	0	500	76.5	76.5	0.0	0.0	71.0	1.9	2.3	0.0	0.0	0.0	0.0	-0.0	1.3	1.3
6	501819.08	5443021.14	2.58	0	1000	73.7	73.7	0.0	0.0	71.0	3.7	-1.2	0.0	0.0	0.0	0.0	-0.0	0.2	0.2
7	501819.08	5443021.14	2.58	0	2000	69.9	69.9	0.0	0.0	71.0	9.7	-1.7	0.0	0.0	0.0	0.0	-0.0	-9.1	-9.1
8	501819.08	5443021.14	2.58	0	4000	64.7	64.7	0.0	0.0	71.0	32.8	-1.7	0.0	0.0	0.0	0.0	-0.0	-37.4	-37.4
9	501819.08	5443021.14	2.58	0	8000	55.6	55.6	0.0	0.0	71.0	117.0	-1.7	0.0	0.0	0.0	0.0	-0.0	-130.8	-130.8

Point Source, ISO 9613, Name: "Ab_Trans4", ID: "Ab_Trans4"																			
Nr.	X	Y	Z	Refl.	Freq.	LxT	LxN	K0	Dc	Adiv	Aatm	Agr	Afol	Ahous	Abar	Cmet	RL	LrT	LrN
	(m)	(m)	(m)		(Hz)	dB(A)	dB(A)	(dB)	(dB)	(dB)	(dB)	(dB)	(dB)	(dB)	(dB)	(dB)	(dB)	dB(A)	dB(A)
1	501819.18	5443200.34	2.58	0	32	37.3	37.3	0.0	0.0	70.1	0.0	-5.6	0.0	0.0	0.0	0.0	-0.0	-27.2	-27.2
2	501819.18	5443200.34	2.58	0	63	56.5	56.5	0.0	0.0	70.1	0.1	-5.6	0.0	0.0	0.0	0.0	-0.0	-8.1	-8.1
3	501819.18	5443200.34	2.58	0	125	68.6	68.6	0.0	0.0	70.1	0.4	4.7	0.0	0.0	0.0	0.0	-0.0	-6.6	-6.6
4	501819.18	5443200.34	2.58	0	250	71.1	71.1	0.0	0.0	70.1	0.9	6.5	0.0	0.0	0.0	0.0	-0.0	-6.5	-6.5
5	501819.18	5443200.34	2.58	0	500	76.5	76.5	0.0	0.0	70.1	1.7	2.3	0.0	0.0	0.0	0.0	-0.0	2.4	2.4
6	501819.18	5443200.34	2.58	0	1000	73.7	73.7	0.0	0.0	70.1	3.3	-1.2	0.0	0.0	0.0	0.0	-0.0	1.6	1.6
7	501819.18	5443200.34	2.58	0	2000	69.9	69.9	0.0	0.0	70.1	8.7	-1.7	0.0	0.0	0.0	0.0	-0.0	-7.2	-7.2
8	501819.18	5443200.34	2.58	0	4000	64.7	64.7	0.0	0.0	70.1	29.4	-1.7	0.0	0.0	0.0	0.0	-0.0	-33.1	-33.1
9	501819.18	5443200.34	2.58	0	8000	55.6	55.6	0.0	0.0	70.1	105.0	-1.7	0.0	0.0	0.0	0.0	-0.0	-117.8	-117.8

Point Source, ISO 9613, Name: "Ab_Trans5", ID: "Ab_Trans5"																			
Nr.	X	Y	Z	Refl.	Freq.	LxT	LxN	K0	Dc	Adiv	Aatm	Agr	Afol	Ahous	Abar	Cmet	RL	LrT	LrN
	(m)	(m)	(m)		(Hz)	dB(A)	dB(A)	(dB)	(dB)	(dB)	(dB)	(dB)	(dB)	(dB)	(dB)	(dB)	(dB)	dB(A)	dB(A)
1	502229.51	5442875.54	2.58	0	32	37.3	37.3	0.0	0.0	74.0	0.1	-5.7	0.0	0.0	0.0	0.0	-0.0	-31.0	-31.0
2	502229.51	5442875.54	2.58	0	63	56.5	56.5	0.0	0.0	74.0	0.2	-5.7	0.0	0.0	0.0	0.0	-0.0	-12.0	-12.0
3	502229.51	5442875.54	2.58	0	125	68.6	68.6	0.0	0.0	74.0	0.6	5.2	0.0	0.0	0.0	0.0	-0.0	-11.3	-11.3
4	502229.51	5442875.54	2.58	0	250	71.1	71.1	0.0	0.0	74.0	1.5	6.5	0.0	0.0	0.0	0.0	-0.0	-10.9	-10.9
5	502229.51	5442875.54	2.58	0	500	76.5	76.5	0.0	0.0	74.0	2.7	2.2	0.0	0.0	0.0	0.0	-0.0	-2.5	-2.5
6	502229.51	5442875.54	2.58	0	1000	73.7	73.7	0.0	0.0	74.0	5.2	-1.3	0.0	0.0	0.0	0.0	-0.0	-4.3	-4.3
7	502229.51	5442875.54	2.58	0	2000	69.9	69.9	0.0	0.0	74.0	13.7	-1.7	0.0	0.0	0.0	0.0	-0.0	-16.1	-16.1
8	502229.51	5442875.54	2.58	0	4000	64.7	64.7	0.0	0.0	74.0	46.5	-1.7	0.0	0.0	0.0	0.0	-0.0	-54.1	-54.1
9	502229.51	5442875.54	2.58	0	8000	55.6	55.6	0.0	0.0	74.0	165.8	-1.7	0.0	0.0	0.0	0.0	-0.0	-182.5	-182.5

Point Source, ISO 9613, Name: "Ab_Trans6", ID: "Ab_Trans6"																			
Nr.	X	Y	Z	Refl.	Freq.	LxT	LxN	K0	Dc	Adiv	Aatm	Agr	Afol	Ahous	Abar	Cmet	RL	LrT	LrN
	(m)	(m)	(m)		(Hz)	dB(A)	dB(A)	(dB)	(dB)	(dB)	(dB)	(dB)	(dB)	(dB)	(dB)	(dB)	(dB)	dB(A)	dB(A)
1	502229.51	5443065.94	2.58	0	32	37.3	37.3	0.0	0.0	73.4	0.0	-5.7	0.0	0.0	0.0	0.0	-0.0	-30.4	-30.4
2	502229.51	5443065.94	2.58	0	63	56.5	56.5	0.0	0.0	73.4	0.2	-5.7	0.0	0.0	0.0	0.0	-0.0	-11.4	-11.4
3	502229.51	5443065.94	2.58	0	125	68.6	68.6	0.0	0.0	73.4	0.5	5.2	0.0	0.0	0.0	0.0	-0.0	-10.6	-10.6
4	502229.51	5443065.94	2.58	0	250	71.1	71.1	0.0	0.0	73.4	1.4	6.5	0.0	0.0	0.0	0.0	-0.0	-10.2	-10.2
5	502229.51	5443065.94	2.58	0	500	76.5	76.5	0.0	0.0	73.4	2.5	2.2	0.0	0.0	0.0	0.0	-0.0	-1.7	-1.7
6	502229.51	5443065.94	2.58	0	1000	73.7	73.7	0.0	0.0	73.4	4.8	-1.3	0.0	0.0	0.0	0.0	-0.0	-3.3	-3.3
7	502229.51	5443065.94	2.58	0	2000	69.9	69.9	0.0	0.0	73.4	12.8	-1.7	0.0	0.0	0.0	0.0	-0.0	-14.6	-14.6
8	502229.51	5443065.94	2.58	0	4000	64.7	64.7	0.0	0.0	73.4	43.4	-1.7	0.0	0.0	0.0	0.0	-0.0	-50.4	-50.4
9	502229.51	5443065.94	2.58	0	8000	55.6	55.6	0.0	0.0	73.4	154.7	-1.7	0.0	0.0	0.0	0.0	-0.0	-170.8	-170.8

Point Source, ISO 9613, Name: "Ab_Trans7", ID: "Ab_Trans7"																			
Nr.	X	Y	Z	Refl.	Freq.	LxT	LxN	K0	Dc	Adiv	Aatm	Agr	Afol	Ahous	Abar	Cmet	RL	LrT	LrN
	(m)	(m)	(m)		(Hz)	dB(A)	dB(A)	(dB)	(dB)	(dB)	(dB)	(dB)	(dB)	(dB)	(dB)	(dB)	(dB)	dB(A)	dB(A)
1	502229.51	5443258.34	2.58	0	32	37.3	37.3	0.0	0.0	72.9	0.0	-5.7	0.0	0.0	0.0	0.0	-0.0	-30.0	-30.0
2	502229.51	5443258.34	2.58	0	63	56.5	56.5	0.0	0.0	72.9	0.2	-5.7	0.0	0.0	0.0	0.0	-0.0	-10.9	-10.9
3	502229.51	5443258.34	2.58	0	125	68.6	68.6	0.0	0.0	72.9	0.5	5.2	0.0	0.0	0.0	0.0	-0.0	-10.0	-10.0
4	502229.51	5443258.34	2.58	0	250	71.1	71.1	0.0	0.0	72.9	1.3	6.5	0.0	0.0	0.0	0.0	-0.0	-9.7	-9.7

Point Source, ISO 9613, Name: "Ab_Trans7", ID: "Ab_Trans7"																			
Nr.	X	Y	Z	Ref.	Freq.	LxT	LxN	K0	Dc	Adiv	Aatm	Agr	Afol	Ahous	Abar	Cmet	RL	LrT	LrN
	(m)	(m)	(m)		(Hz)	dB(A)	dB(A)	(dB)	(dB)	(dB)	(dB)	(dB)	(dB)	(dB)	(dB)	(dB)	(dB)	dB(A)	dB(A)
5	502229.51	5443258.34	2.58	0	500	76.5	76.5	0.0	0.0	72.9	2.4	2.2	0.0	0.0	0.0	0.0	-0.0	-1.1	-1.1
6	502229.51	5443258.34	2.58	0	1000	73.7	73.7	0.0	0.0	72.9	4.6	-1.2	0.0	0.0	0.0	0.0	-0.0	-2.6	-2.6
7	502229.51	5443258.34	2.58	0	2000	69.9	69.9	0.0	0.0	72.9	12.1	-1.7	0.0	0.0	0.0	0.0	-0.0	-13.4	-13.4
8	502229.51	5443258.34	2.58	0	4000	64.7	64.7	0.0	0.0	72.9	40.9	-1.7	0.0	0.0	0.0	0.0	-0.0	-47.5	-47.5
9	502229.51	5443258.34	2.58	0	8000	55.6	55.6	0.0	0.0	72.9	146.1	-1.7	0.0	0.0	0.0	0.0	-0.0	-161.7	-161.7

Point Source, ISO 9613, Name: "Em_Sub115", ID: "Em_Sub115"																			
Nr.	X	Y	Z	Ref.	Freq.	LxT	LxN	K0	Dc	Adiv	Aatm	Agr	Afol	Ahous	Abar	Cmet	RL	LrT	LrN
	(m)	(m)	(m)		(Hz)	dB(A)	dB(A)	(dB)	(dB)	(dB)	(dB)	(dB)	(dB)	(dB)	(dB)	(dB)	(dB)	dB(A)	dB(A)
1	500978.58	5443536.29	3.60	0	32	43.3	43.3	0.0	0.0	53.8	0.0	-3.0	0.0	0.0	0.0	0.0	-0.0	-7.5	-7.5
2	500978.58	5443536.29	3.60	0	63	60.5	60.5	0.0	0.0	53.8	0.0	-3.0	0.0	0.0	0.0	0.0	-0.0	9.7	9.7
3	500978.58	5443536.29	3.60	0	125	73.6	73.6	0.0	0.0	53.8	0.1	1.3	0.0	0.0	0.0	0.0	-0.0	18.4	18.4
4	500978.58	5443536.29	3.60	0	250	79.1	79.1	0.0	0.0	53.8	0.1	5.5	0.0	0.0	0.0	0.0	-0.0	19.8	19.8
5	500978.58	5443536.29	3.60	0	500	84.5	84.5	0.0	0.0	53.8	0.3	2.4	0.0	0.0	0.0	0.0	-0.0	28.1	28.1
6	500978.58	5443536.29	3.60	0	1000	81.7	81.7	0.0	0.0	53.8	0.5	-0.5	0.0	0.0	0.0	0.0	-0.0	27.9	27.9
7	500978.58	5443536.29	3.60	0	2000	77.9	77.9	0.0	0.0	53.8	1.3	-0.9	0.0	0.0	0.0	0.0	-0.0	23.7	23.7
8	500978.58	5443536.29	3.60	0	4000	72.7	72.7	0.0	0.0	53.8	4.5	-0.9	0.0	0.0	0.0	0.0	-0.0	15.4	15.4
9	500978.58	5443536.29	3.60	0	8000	62.6	62.6	0.0	0.0	53.8	16.1	-0.9	0.0	0.0	0.0	0.0	-0.0	-6.3	-6.3

Point Source, ISO 9613, Name: "Em_Inv1", ID: "Em_Inv1"																			
Nr.	X	Y	Z	Ref.	Freq.	LxT	LxN	K0	Dc	Adiv	Aatm	Agr	Afol	Ahous	Abar	Cmet	RL	LrT	LrN
	(m)	(m)	(m)		(Hz)	dB(A)	dB(A)	(dB)	(dB)	(dB)	(dB)	(dB)	(dB)	(dB)	(dB)	(dB)	(dB)	dB(A)	dB(A)
1	500760.53	5441418.41	2.60	0	63	68.1	68.1	0.0	0.0	78.1	0.3	-5.8	0.0	0.0	0.0	0.0	-0.0	-4.4	-4.4
2	500760.53	5441418.41	2.60	0	125	78.9	78.9	0.0	0.0	78.1	0.9	5.2	0.0	0.0	0.0	0.0	-0.0	-5.3	-5.3
3	500760.53	5441418.41	2.60	0	250	85.5	85.5	0.0	0.0	78.1	2.3	6.4	0.0	0.0	0.0	0.0	-0.0	-1.4	-1.4
4	500760.53	5441418.41	2.60	0	500	87.3	87.3	0.0	0.0	78.1	4.3	2.2	0.0	0.0	0.0	0.0	-0.0	2.7	2.7
5	500760.53	5441418.41	2.60	0	1000	83.7	83.7	0.0	0.0	78.1	8.3	-1.3	0.0	0.0	0.0	0.0	-0.0	-1.3	-1.3
6	500760.53	5441418.41	2.60	0	2000	79.1	79.1	0.0	0.0	78.1	21.8	-1.8	0.0	0.0	0.0	0.0	-0.0	-19.0	-19.0
7	500760.53	5441418.41	2.60	0	4000	70.0	70.0	0.0	0.0	78.1	73.9	-1.8	0.0	0.0	0.0	0.0	-0.0	-80.3	-80.3
8	500760.53	5441418.41	2.60	0	8000	77.7	77.7	0.0	0.0	78.1	263.7	-1.8	0.0	0.0	0.0	0.0	-0.0	-262.3	-262.3

Point Source, ISO 9613, Name: "Em_Inv2", ID: "Em_Inv2"																			
Nr.	X	Y	Z	Ref.	Freq.	LxT	LxN	K0	Dc	Adiv	Aatm	Agr	Afol	Ahous	Abar	Cmet	RL	LrT	LrN
	(m)	(m)	(m)		(Hz)	dB(A)	dB(A)	(dB)	(dB)	(dB)	(dB)	(dB)	(dB)	(dB)	(dB)	(dB)	(dB)	dB(A)	dB(A)
1	500552.40	5441520.21	2.60	0	63	68.1	68.1	0.0	0.0	77.8	0.3	-5.8	0.0	0.0	0.0	0.0	-0.0	-4.1	-4.1
2	500552.40	5441520.21	2.60	0	125	78.9	78.9	0.0	0.0	77.8	0.9	5.2	0.0	0.0	0.0	0.0	-0.0	-5.0	-5.0
3	500552.40	5441520.21	2.60	0	250	85.5	85.5	0.0	0.0	77.8	2.3	6.4	0.0	0.0	0.0	0.0	-0.0	-1.1	-1.1
4	500552.40	5441520.21	2.60	0	500	87.3	87.3	0.0	0.0	77.8	4.2	2.2	0.0	0.0	0.0	0.0	-0.0	3.1	3.1
5	500552.40	5441520.21	2.60	0	1000	83.7	83.7	0.0	0.0	77.8	8.0	-1.3	0.0	0.0	0.0	0.0	-0.0	-0.9	-0.9
6	500552.40	5441520.21	2.60	0	2000	79.1	79.1	0.0	0.0	77.8	21.2	-1.8	0.0	0.0	0.0	0.0	-0.0	-18.2	-18.2
7	500552.40	5441520.21	2.60	0	4000	70.0	70.0	0.0	0.0	77.8	71.8	-1.8	0.0	0.0	0.0	0.0	-0.0	-77.9	-77.9
8	500552.40	5441520.21	2.60	0	8000	77.7	77.7	0.0	0.0	77.8	256.2	-1.8	0.0	0.0	0.0	0.0	-0.0	-254.6	-254.6

Point Source, ISO 9613, Name: "Em_Inv3", ID: "Em_Inv3"																			
Nr.	X	Y	Z	Ref.	Freq.	LxT	LxN	K0	Dc	Adiv	Aatm	Agr	Afol	Ahous	Abar	Cmet	RL	LrT	LrN
	(m)	(m)	(m)		(Hz)	dB(A)	dB(A)	(dB)	(dB)	(dB)	(dB)	(dB)	(dB)	(dB)	(dB)	(dB)	(dB)	dB(A)	dB(A)
1	500760.53	5441687.21	2.60	0	63	68.1	68.1	0.0	0.0	77.0	0.2	-5.8	0.0	0.0	0.0	0.0	-0.0	-3.3	-3.3
2	500760.53	5441687.21	2.60	0	125	78.9	78.9	0.0	0.0	77.0	0.8	5.2	0.0	0.0	0.0	0.0	-0.0	-4.1	-4.1
3	500760.53	5441687.21	2.60	0	250	85.5	85.5	0.0	0.0	77.0	2.1	6.5	0.0	0.0	0.0	0.0	-0.0	0.0	0.0
4	500760.53	5441687.21	2.60	0	500	87.3	87.3	0.0	0.0	77.0	3.8	2.2	0.0	0.0	0.0	0.0	-0.0	4.3	4.3
5	500760.53	5441687.21	2.60	0	1000	83.7	83.7	0.0	0.0	77.0	7.3	-1.3	0.0	0.0	0.0	0.0	-0.0	0.7	0.7
6	500760.53	5441687.21	2.60	0	2000	79.1	79.1	0.0	0.0	77.0	19.2	-1.7	0.0	0.0	0.0	0.0	-0.0	-15.4	-15.4
7	500760.53	5441687.21	2.60	0	4000	70.0	70.0	0.0	0.0	77.0	65.2	-1.7	0.0	0.0	0.0	0.0	-0.0	-70.4	-70.4
8	500760.53	5441687.21	2.60	0	8000	77.7	77.7	0.0	0.0	77.0	232.6	-1.7	0.0	0.0	0.0	0.0	-0.0	-230.1	-230.1

Point Source, ISO 9613, Name: "Em_Inv4", ID: "Em_Inv4"																			
Nr.	X	Y	Z	Ref.	Freq.	LxT	LxN	K0	Dc	Adiv	Aatm	Agr	Afol	Ahous	Abar	Cmet	RL	LrT	LrN
	(m)	(m)	(m)		(Hz)	dB(A)	dB(A)	(dB)	(dB)	(dB)	(dB)	(dB)	(dB)	(dB)	(dB)	(dB)	(dB)	dB(A)	dB(A)
1	500516.20	5441733.01	2.60	0	63	68.1	68.1	0.0	0.0	77.0	0.2	-5.8	0.0	0.0	0.0	0.0	-0.0	-3.3	-3.3
2	500516.20	5441733.01	2.60	0	125	78.9	78.9	0.0	0.0	77.0	0.8	5.2	0.0	0.0	0.0	0.0	-0.0	-4.1	-4.1
3	500516.20	5441733.01	2.60	0	250	85.5	85.5	0.0	0.0	77.0	2.1	6.5	0.0	0.0	0.0	0.0	-0.0	-0.0	-0.0
4	500516.20	5441733.01	2.60	0	500	87.3	87.3	0.0	0.0	77.0	3.8	2.2	0.0	0.0	0.0	0.0	-0.0	4.3	4.3
5	500516.20	5441733.01	2.60	0	1000	83.7	83.7	0.0	0.0	77.0	7.3	-1.3	0.0	0.0	0.0	0.0	-0.0	0.7	0.7

Point Source, ISO 9613, Name: "Em_Inv4", ID: "Em_Inv4"																			
Nr.	X	Y	Z	Refl.	Freq.	LxT	LxN	K0	Dc	Adiv	Aatm	Agr	Afol	Ahous	Abar	Cmet	RL	LrT	LrN
	(m)	(m)	(m)		(Hz)	dB(A)	dB(A)	(dB)	(dB)	(dB)	(dB)	(dB)	(dB)	(dB)	(dB)	(dB)	(dB)	dB(A)	dB(A)
6	500516.20	5441733.01	2.60	0	2000	79.1	79.1	0.0	0.0	77.0	19.3	-1.7	0.0	0.0	0.0	0.0	-0.0	-15.4	-15.4
7	500516.20	5441733.01	2.60	0	4000	70.0	70.0	0.0	0.0	77.0	65.4	-1.7	0.0	0.0	0.0	0.0	-0.0	-70.6	-70.6
8	500516.20	5441733.01	2.60	0	8000	77.7	77.7	0.0	0.0	77.0	233.2	-1.7	0.0	0.0	0.0	0.0	-0.0	-230.7	-230.7

Point Source, ISO 9613, Name: "Em_Inv5", ID: "Em_Inv5"																			
Nr.	X	Y	Z	Refl.	Freq.	LxT	LxN	K0	Dc	Adiv	Aatm	Agr	Afol	Ahous	Abar	Cmet	RL	LrT	LrN
	(m)	(m)	(m)		(Hz)	dB(A)	dB(A)	(dB)	(dB)	(dB)	(dB)	(dB)	(dB)	(dB)	(dB)	(dB)	(dB)	dB(A)	dB(A)
1	500760.53	5441956.01	2.60	0	63	68.1	68.1	0.0	0.0	75.7	0.2	-5.8	0.0	0.0	0.0	0.0	-0.0	-2.0	-2.0
2	500760.53	5441956.01	2.60	0	125	78.9	78.9	0.0	0.0	75.7	0.7	5.2	0.0	0.0	0.0	0.0	-0.0	-2.8	-2.8
3	500760.53	5441956.01	2.60	0	250	85.5	85.5	0.0	0.0	75.7	1.8	6.5	0.0	0.0	0.0	0.0	-0.0	1.5	1.5
4	500760.53	5441956.01	2.60	0	500	87.3	87.3	0.0	0.0	75.7	3.3	2.2	0.0	0.0	0.0	0.0	-0.0	6.1	6.1
5	500760.53	5441956.01	2.60	0	1000	83.7	83.7	0.0	0.0	75.7	6.3	-1.3	0.0	0.0	0.0	0.0	-0.0	2.9	2.9
6	500760.53	5441956.01	2.60	0	2000	79.1	79.1	0.0	0.0	75.7	16.7	-1.7	0.0	0.0	0.0	0.0	-0.0	-11.6	-11.6
7	500760.53	5441956.01	2.60	0	4000	70.0	70.0	0.0	0.0	75.7	56.5	-1.7	0.0	0.0	0.0	0.0	-0.0	-60.5	-60.5
8	500760.53	5441956.01	2.60	0	8000	77.7	77.7	0.0	0.0	75.7	201.5	-1.7	0.0	0.0	0.0	0.0	-0.0	-197.8	-197.8

Point Source, ISO 9613, Name: "Em_Inv6", ID: "Em_Inv6"																			
Nr.	X	Y	Z	Refl.	Freq.	LxT	LxN	K0	Dc	Adiv	Aatm	Agr	Afol	Ahous	Abar	Cmet	RL	LrT	LrN
	(m)	(m)	(m)		(Hz)	dB(A)	dB(A)	(dB)	(dB)	(dB)	(dB)	(dB)	(dB)	(dB)	(dB)	(dB)	(dB)	dB(A)	dB(A)
1	500498.10	5441901.01	2.60	0	63	68.1	68.1	0.0	0.0	76.3	0.2	-5.8	0.0	0.0	0.0	0.0	-0.0	-2.6	-2.6
2	500498.10	5441901.01	2.60	0	125	78.9	78.9	0.0	0.0	76.3	0.8	5.2	0.0	0.0	0.0	0.0	-0.0	-3.4	-3.4
3	500498.10	5441901.01	2.60	0	250	85.5	85.5	0.0	0.0	76.3	1.9	6.5	0.0	0.0	0.0	0.0	-0.0	0.8	0.8
4	500498.10	5441901.01	2.60	0	500	87.3	87.3	0.0	0.0	76.3	3.5	2.2	0.0	0.0	0.0	0.0	-0.0	5.3	5.3
5	500498.10	5441901.01	2.60	0	1000	83.7	83.7	0.0	0.0	76.3	6.7	-1.3	0.0	0.0	0.0	0.0	-0.0	2.0	2.0
6	500498.10	5441901.01	2.60	0	2000	79.1	79.1	0.0	0.0	76.3	17.8	-1.7	0.0	0.0	0.0	0.0	-0.0	-13.2	-13.2
7	500498.10	5441901.01	2.60	0	4000	70.0	70.0	0.0	0.0	76.3	60.3	-1.7	0.0	0.0	0.0	0.0	-0.0	-64.8	-64.8
8	500498.10	5441901.01	2.60	0	8000	77.7	77.7	0.0	0.0	76.3	214.9	-1.7	0.0	0.0	0.0	0.0	-0.0	-211.8	-211.8

Point Source, ISO 9613, Name: "Em_Inv7", ID: "Em_Inv7"																			
Nr.	X	Y	Z	Refl.	Freq.	LxT	LxN	K0	Dc	Adiv	Aatm	Agr	Afol	Ahous	Abar	Cmet	RL	LrT	LrN
	(m)	(m)	(m)		(Hz)	dB(A)	dB(A)	(dB)	(dB)	(dB)	(dB)	(dB)	(dB)	(dB)	(dB)	(dB)	(dB)	dB(A)	dB(A)
1	500498.10	5442057.81	2.60	0	63	68.1	68.1	0.0	0.0	75.6	0.2	-5.8	0.0	0.0	0.0	0.0	-0.0	-1.9	-1.9
2	500498.10	5442057.81	2.60	0	125	78.9	78.9	0.0	0.0	75.6	0.7	5.2	0.0	0.0	0.0	0.0	-0.0	-2.6	-2.6
3	500498.10	5442057.81	2.60	0	250	85.5	85.5	0.0	0.0	75.6	1.8	6.5	0.0	0.0	0.0	0.0	-0.0	1.7	1.7
4	500498.10	5442057.81	2.60	0	500	87.3	87.3	0.0	0.0	75.6	3.3	2.2	0.0	0.0	0.0	0.0	-0.0	6.3	6.3
5	500498.10	5442057.81	2.60	0	1000	83.7	83.7	0.0	0.0	75.6	6.2	-1.3	0.0	0.0	0.0	0.0	-0.0	3.2	3.2
6	500498.10	5442057.81	2.60	0	2000	79.1	79.1	0.0	0.0	75.6	16.3	-1.7	0.0	0.0	0.0	0.0	-0.0	-11.1	-11.1
7	500498.10	5442057.81	2.60	0	4000	70.0	70.0	0.0	0.0	75.6	55.4	-1.7	0.0	0.0	0.0	0.0	-0.0	-59.2	-59.2
8	500498.10	5442057.81	2.60	0	8000	77.7	77.7	0.0	0.0	75.6	197.5	-1.7	0.0	0.0	0.0	0.0	-0.0	-193.6	-193.6

Point Source, ISO 9613, Name: "Em_Inv8", ID: "Em_Inv8"																			
Nr.	X	Y	Z	Refl.	Freq.	LxT	LxN	K0	Dc	Adiv	Aatm	Agr	Afol	Ahous	Abar	Cmet	RL	LrT	LrN
	(m)	(m)	(m)		(Hz)	dB(A)	dB(A)	(dB)	(dB)	(dB)	(dB)	(dB)	(dB)	(dB)	(dB)	(dB)	(dB)	dB(A)	dB(A)
1	500461.90	5442281.81	2.60	0	63	68.1	68.1	0.0	0.0	74.5	0.2	-5.8	0.0	0.0	0.0	0.0	-0.0	-0.8	-0.8
2	500461.90	5442281.81	2.60	0	125	78.9	78.9	0.0	0.0	74.5	0.6	5.2	0.0	0.0	0.0	0.0	-0.0	-1.4	-1.4
3	500461.90	5442281.81	2.60	0	250	85.5	85.5	0.0	0.0	74.5	1.6	6.5	0.0	0.0	0.0	0.0	-0.0	3.0	3.0
4	500461.90	5442281.81	2.60	0	500	87.3	87.3	0.0	0.0	74.5	2.9	2.2	0.0	0.0	0.0	0.0	-0.0	7.8	7.8
5	500461.90	5442281.81	2.60	0	1000	83.7	83.7	0.0	0.0	74.5	5.5	-1.3	0.0	0.0	0.0	0.0	-0.0	5.0	5.0
6	500461.90	5442281.81	2.60	0	2000	79.1	79.1	0.0	0.0	74.5	14.4	-1.7	0.0	0.0	0.0	0.0	-0.0	-8.1	-8.1
7	500461.90	5442281.81	2.60	0	4000	70.0	70.0	0.0	0.0	74.5	48.9	-1.7	0.0	0.0	0.0	0.0	-0.0	-51.7	-51.7
8	500461.90	5442281.81	2.60	0	8000	77.7	77.7	0.0	0.0	74.5	174.5	-1.7	0.0	0.0	0.0	0.0	-0.0	-169.6	-169.6

Point Source, ISO 9613, Name: "Em_Inv9", ID: "Em_Inv9"																			
Nr.	X	Y	Z	Refl.	Freq.	LxT	LxN	K0	Dc	Adiv	Aatm	Agr	Afol	Ahous	Abar	Cmet	RL	LrT	LrN
	(m)	(m)	(m)		(Hz)	dB(A)	dB(A)	(dB)	(dB)	(dB)	(dB)	(dB)	(dB)	(dB)	(dB)	(dB)	(dB)	dB(A)	dB(A)
1	500651.93	5442280.81	2.60	0	63	68.1	68.1	0.0	0.0	74.1	0.2	-5.7	0.0	0.0	0.0	0.0	-0.0	-0.4	-0.4
2	500651.93	5442280.81	2.60	0	125	78.9	78.9	0.0	0.0	74.1	0.6	5.2	0.0	0.0	0.0	0.0	-0.0	-1.0	-1.0
3	500651.93	5442280.81	2.60	0	250	85.5	85.5	0.0	0.0	74.1	1.5	6.5	0.0	0.0	0.0	0.0	-0.0	3.4	3.4
4	500651.93	5442280.81	2.60	0	500	87.3	87.3	0.0	0.0	74.1	2.8	2.2	0.0	0.0	0.0	0.0	-0.0	8.2	8.2
5	500651.93	5442280.81	2.60	0	1000	83.7	83.7	0.0	0.0	74.1	5.2	-1.3	0.0	0.0	0.0	0.0	-0.0	5.6	5.6
6	500651.93	5442280.81	2.60	0	2000	79.1	79.1	0.0	0.0	74.1	13.8	-1.7	0.0	0.0	0.0	0.0	-0.0	-7.1	-7.1
7	500651.93	5442280.81	2.60	0	4000	70.0	70.0	0.0	0.0	74.1	46.9	-1.7	0.0	0.0	0.0	0.0	-0.0	-49.3	-49.3
8	500651.93	5442280.81	2.60	0	8000	77.7	77.7	0.0	0.0	74.1	167.2	-1.7	0.0	0.0	0.0	0.0	-0.0	-161.9	-161.9

Point Source, ISO 9613, Name: "Em_Inv10", ID: "Em_Inv10"																			
Nr.	X	Y	Z	Refl.	Freq.	LxT	LxN	K0	Dc	Adiv	Aatm	Agr	Afol	Ahous	Abar	Cmet	RL	LrT	LrN
	(m)	(m)	(m)		(Hz)	dB(A)	dB(A)	(dB)	(dB)	(dB)	(dB)	(dB)	(dB)	(dB)	(dB)	(dB)	(dB)	dB(A)	dB(A)
1	499992.71	5441665.81	2.60	0	63	68.1	68.1	0.0	0.0	78.0	0.3	-5.8	0.0	0.0	0.0	0.0	-0.0	-4.4	-4.4
2	499992.71	5441665.81	2.60	0	125	78.9	78.9	0.0	0.0	78.0	0.9	5.2	0.0	0.0	0.0	0.0	-0.0	-5.3	-5.3
3	499992.71	5441665.81	2.60	0	250	85.5	85.5	0.0	0.0	78.0	2.3	6.4	0.0	0.0	0.0	0.0	-0.0	-1.3	-1.3
4	499992.71	5441665.81	2.60	0	500	87.3	87.3	0.0	0.0	78.0	4.3	2.2	0.0	0.0	0.0	0.0	-0.0	2.7	2.7
5	499992.71	5441665.81	2.60	0	1000	83.7	83.7	0.0	0.0	78.0	8.2	-1.3	0.0	0.0	0.0	0.0	-0.0	-1.3	-1.3
6	499992.71	5441665.81	2.60	0	2000	79.1	79.1	0.0	0.0	78.0	21.8	-1.8	0.0	0.0	0.0	0.0	-0.0	-19.0	-19.0
7	499992.71	5441665.81	2.60	0	4000	70.0	70.0	0.0	0.0	78.0	73.8	-1.8	0.0	0.0	0.0	0.0	-0.0	-80.1	-80.1
8	499992.71	5441665.81	2.60	0	8000	77.7	77.7	0.0	0.0	78.0	263.2	-1.8	0.0	0.0	0.0	0.0	-0.0	-261.8	-261.8

Point Source, ISO 9613, Name: "Em_Inv11", ID: "Em_Inv11"																			
Nr.	X	Y	Z	Refl.	Freq.	LxT	LxN	K0	Dc	Adiv	Aatm	Agr	Afol	Ahous	Abar	Cmet	RL	LrT	LrN
	(m)	(m)	(m)		(Hz)	dB(A)	dB(A)	(dB)	(dB)	(dB)	(dB)	(dB)	(dB)	(dB)	(dB)	(dB)	(dB)	dB(A)	dB(A)
1	499992.71	5441505.71	2.60	0	63	68.1	68.1	0.0	0.0	78.6	0.3	-5.8	0.0	0.0	0.0	0.0	-0.0	-4.9	-4.9
2	499992.71	5441505.71	2.60	0	125	78.9	78.9	0.0	0.0	78.6	1.0	5.2	0.0	0.0	0.0	0.0	-0.0	-5.9	-5.9
3	499992.71	5441505.71	2.60	0	250	85.5	85.5	0.0	0.0	78.6	2.5	6.4	0.0	0.0	0.0	0.0	-0.0	-2.0	-2.0
4	499992.71	5441505.71	2.60	0	500	87.3	87.3	0.0	0.0	78.6	4.6	2.2	0.0	0.0	0.0	0.0	-0.0	1.9	1.9
5	499992.71	5441505.71	2.60	0	1000	83.7	83.7	0.0	0.0	78.6	8.8	-1.3	0.0	0.0	0.0	0.0	-0.0	-2.4	-2.4
6	499992.71	5441505.71	2.60	0	2000	79.1	79.1	0.0	0.0	78.6	23.1	-1.8	0.0	0.0	0.0	0.0	-0.0	-20.9	-20.9
7	499992.71	5441505.71	2.60	0	4000	70.0	70.0	0.0	0.0	78.6	78.5	-1.8	0.0	0.0	0.0	0.0	-0.0	-85.3	-85.3
8	499992.71	5441505.71	2.60	0	8000	77.7	77.7	0.0	0.0	78.6	279.9	-1.8	0.0	0.0	0.0	0.0	-0.0	-279.0	-279.0

Point Source, ISO 9613, Name: "Em_Trans1", ID: "Em_Trans1"																			
Nr.	X	Y	Z	Refl.	Freq.	LxT	LxN	K0	Dc	Adiv	Aatm	Agr	Afol	Ahous	Abar	Cmet	RL	LrT	LrN
	(m)	(m)	(m)		(Hz)	dB(A)	dB(A)	(dB)	(dB)	(dB)	(dB)	(dB)	(dB)	(dB)	(dB)	(dB)	(dB)	dB(A)	dB(A)
1	500755.03	5441418.91	2.58	0	32	37.3	37.3	0.0	0.0	78.1	0.1	-5.8	0.0	0.0	0.0	0.0	-0.0	-35.0	-35.0
2	500755.03	5441418.91	2.58	0	63	56.5	56.5	0.0	0.0	78.1	0.3	-5.8	0.0	0.0	0.0	0.0	-0.0	-16.0	-16.0
3	500755.03	5441418.91	2.58	0	125	68.6	68.6	0.0	0.0	78.1	0.9	5.2	0.0	0.0	0.0	0.0	-0.0	-15.6	-15.6
4	500755.03	5441418.91	2.58	0	250	71.1	71.1	0.0	0.0	78.1	2.3	6.5	0.0	0.0	0.0	0.0	-0.0	-15.8	-15.8
5	500755.03	5441418.91	2.58	0	500	76.5	76.5	0.0	0.0	78.1	4.3	2.2	0.0	0.0	0.0	0.0	-0.0	-8.1	-8.1
6	500755.03	5441418.91	2.58	0	1000	73.7	73.7	0.0	0.0	78.1	8.3	-1.3	0.0	0.0	0.0	0.0	-0.0	-11.3	-11.3
7	500755.03	5441418.91	2.58	0	2000	69.9	69.9	0.0	0.0	78.1	21.8	-1.8	0.0	0.0	0.0	0.0	-0.0	-28.2	-28.2
8	500755.03	5441418.91	2.58	0	4000	64.7	64.7	0.0	0.0	78.1	73.9	-1.8	0.0	0.0	0.0	0.0	-0.0	-85.5	-85.5
9	500755.03	5441418.91	2.58	0	8000	55.6	55.6	0.0	0.0	78.1	263.7	-1.8	0.0	0.0	0.0	0.0	-0.0	-284.4	-284.4

Point Source, ISO 9613, Name: "Em_Trans2", ID: "Em_Trans2"																			
Nr.	X	Y	Z	Refl.	Freq.	LxT	LxN	K0	Dc	Adiv	Aatm	Agr	Afol	Ahous	Abar	Cmet	RL	LrT	LrN
	(m)	(m)	(m)		(Hz)	dB(A)	dB(A)	(dB)	(dB)	(dB)	(dB)	(dB)	(dB)	(dB)	(dB)	(dB)	(dB)	dB(A)	dB(A)
1	500557.90	5441519.71	2.58	0	32	37.3	37.3	0.0	0.0	77.8	0.1	-5.8	0.0	0.0	0.0	0.0	-0.0	-34.8	-34.8
2	500557.90	5441519.71	2.58	0	63	56.5	56.5	0.0	0.0	77.8	0.3	-5.8	0.0	0.0	0.0	0.0	-0.0	-15.8	-15.8
3	500557.90	5441519.71	2.58	0	125	68.6	68.6	0.0	0.0	77.8	0.9	5.2	0.0	0.0	0.0	0.0	-0.0	-15.3	-15.3
4	500557.90	5441519.71	2.58	0	250	71.1	71.1	0.0	0.0	77.8	2.3	6.5	0.0	0.0	0.0	0.0	-0.0	-15.5	-15.5
5	500557.90	5441519.71	2.58	0	500	76.5	76.5	0.0	0.0	77.8	4.2	2.2	0.0	0.0	0.0	0.0	-0.0	-7.7	-7.7
6	500557.90	5441519.71	2.58	0	1000	73.7	73.7	0.0	0.0	77.8	8.0	-1.3	0.0	0.0	0.0	0.0	-0.0	-10.9	-10.9
7	500557.90	5441519.71	2.58	0	2000	69.9	69.9	0.0	0.0	77.8	21.2	-1.8	0.0	0.0	0.0	0.0	-0.0	-27.3	-27.3
8	500557.90	5441519.71	2.58	0	4000	64.7	64.7	0.0	0.0	77.8	71.8	-1.8	0.0	0.0	0.0	0.0	-0.0	-83.2	-83.2
9	500557.90	5441519.71	2.58	0	8000	55.6	55.6	0.0	0.0	77.8	256.2	-1.8	0.0	0.0	0.0	0.0	-0.0	-276.6	-276.6

Point Source, ISO 9613, Name: "Em_Trans3", ID: "Em_Trans3"																			
Nr.	X	Y	Z	Refl.	Freq.	LxT	LxN	K0	Dc	Adiv	Aatm	Agr	Afol	Ahous	Abar	Cmet	RL	LrT	LrN
	(m)	(m)	(m)		(Hz)	dB(A)	dB(A)	(dB)	(dB)	(dB)	(dB)	(dB)	(dB)	(dB)	(dB)	(dB)	(dB)	dB(A)	dB(A)
1	500755.03	5441687.71	2.58	0	32	37.3	37.3	0.0	0.0	77.0	0.1	-5.8	0.0	0.0	0.0	0.0	-0.0	-33.9	-33.9
2	500755.03	5441687.71	2.58	0	63	56.5	56.5	0.0	0.0	77.0	0.2	-5.8	0.0	0.0	0.0	0.0	-0.0	-14.9	-14.9
3	500755.03	5441687.71	2.58	0	125	68.6	68.6	0.0	0.0	77.0	0.8	5.2	0.0	0.0	0.0	0.0	-0.0	-14.4	-14.4
4	500755.03	5441687.71	2.58	0	250	71.1	71.1	0.0	0.0	77.0	2.1	6.5	0.0	0.0	0.0	0.0	-0.0	-14.4	-14.4
5	500755.03	5441687.71	2.58	0	500	76.5	76.5	0.0	0.0	77.0	3.8	2.2	0.0	0.0	0.0	0.0	-0.0	-6.5	-6.5
6	500755.03	5441687.71	2.58	0	1000	73.7	73.7	0.0	0.0	77.0	7.3	-1.3	0.0	0.0	0.0	0.0	-0.0	-9.3	-9.3
7	500755.03	5441687.71	2.58	0	2000	69.9	69.9	0.0	0.0	77.0	19.2	-1.7	0.0	0.0	0.0	0.0	-0.0	-24.6	-24.6
8	500755.03	5441687.71	2.58	0	4000	64.7	64.7	0.0	0.0	77.0	65.2	-1.7	0.0	0.0	0.0	0.0	-0.0	-75.7	-75.7
9	500755.03	5441687.71	2.58	0	8000	55.6	55.6	0.0	0.0	77.0	232.6	-1.7	0.0	0.0	0.0	0.0	-0.0	-252.2	-252.2

Point Source, ISO 9613, Name: "Em_Trans4", ID: "Em_Trans4"																			
Nr.	X	Y	Z	Refl.	Freq.	LxT	LxN	K0	Dc	Adiv	Aatm	Agr	Afol	Ahous	Abar	Cmet	RL	LrT	LrN
	(m)	(m)	(m)		(Hz)	dB(A)	dB(A)	(dB)	(dB)	(dB)	(dB)	(dB)	(dB)	(dB)	(dB)	(dB)	(dB)	dB(A)	dB(A)
1	500521.70	5441732.51	2.58	0	32	37.3	37.3	0.0	0.0	77.0	0.1	-5.8	0.0	0.0	0.0	0.0	-0.0	-33.9	-33.9
2	500521.70	5441732.51	2.58	0	63	56.5	56.5	0.0	0.0	77.0	0.2	-5.8	0.0	0.0	0.0	0.0	-0.0	-14.9	-14.9
3	500521.70	5441732.51	2.58	0	125	68.6	68.6	0.0	0.0	77.0	0.8	5.2	0.0	0.0	0.0	0.0	-0.0	-14.4	-14.4
4	500521.70	5441732.51	2.58	0	250	71.1	71.1	0.0	0.0	77.0	2.1	6.5	0.0	0.0	0.0	0.0	-0.0	-14.5	-14.5
5	500521.70	5441732.51	2.58	0	500	76.5	76.5	0.0	0.0	77.0	3.8	2.2	0.0	0.0	0.0	0.0	-0.0	-6.5	-6.5
6	500521.70	5441732.51	2.58	0	1000	73.7	73.7	0.0	0.0	77.0	7.3	-1.3	0.0	0.0	0.0	0.0	-0.0	-9.3	-9.3
7	500521.70	5441732.51	2.58	0	2000	69.9	69.9	0.0	0.0	77.0	19.3	-1.7	0.0	0.0	0.0	0.0	-0.0	-24.6	-24.6
8	500521.70	5441732.51	2.58	0	4000	64.7	64.7	0.0	0.0	77.0	65.3	-1.7	0.0	0.0	0.0	0.0	-0.0	-75.9	-75.9
9	500521.70	5441732.51	2.58	0	8000	55.6	55.6	0.0	0.0	77.0	233.0	-1.7	0.0	0.0	0.0	0.0	-0.0	-252.7	-252.7

Point Source, ISO 9613, Name: "Em_Trans5", ID: "Em_Trans5"																			
Nr.	X	Y	Z	Refl.	Freq.	LxT	LxN	K0	Dc	Adiv	Aatm	Agr	Afol	Ahous	Abar	Cmet	RL	LrT	LrN
	(m)	(m)	(m)		(Hz)	dB(A)	dB(A)	(dB)	(dB)	(dB)	(dB)	(dB)	(dB)	(dB)	(dB)	(dB)	(dB)	dB(A)	dB(A)
1	500755.03	5441956.51	2.58	0	32	37.3	37.3	0.0	0.0	75.7	0.1	-5.8	0.0	0.0	0.0	0.0	-0.0	-32.7	-32.7
2	500755.03	5441956.51	2.58	0	63	56.5	56.5	0.0	0.0	75.7	0.2	-5.8	0.0	0.0	0.0	0.0	-0.0	-13.7	-13.7
3	500755.03	5441956.51	2.58	0	125	68.6	68.6	0.0	0.0	75.7	0.7	5.2	0.0	0.0	0.0	0.0	-0.0	-13.1	-13.1
4	500755.03	5441956.51	2.58	0	250	71.1	71.1	0.0	0.0	75.7	1.8	6.5	0.0	0.0	0.0	0.0	-0.0	-12.9	-12.9
5	500755.03	5441956.51	2.58	0	500	76.5	76.5	0.0	0.0	75.7	3.3	2.2	0.0	0.0	0.0	0.0	-0.0	-4.8	-4.8
6	500755.03	5441956.51	2.58	0	1000	73.7	73.7	0.0	0.0	75.7	6.3	-1.3	0.0	0.0	0.0	0.0	-0.0	-7.1	-7.1
7	500755.03	5441956.51	2.58	0	2000	69.9	69.9	0.0	0.0	75.7	16.7	-1.7	0.0	0.0	0.0	0.0	-0.0	-20.8	-20.8
8	500755.03	5441956.51	2.58	0	4000	64.7	64.7	0.0	0.0	75.7	56.5	-1.7	0.0	0.0	0.0	0.0	-0.0	-65.8	-65.8
9	500755.03	5441956.51	2.58	0	8000	55.6	55.6	0.0	0.0	75.7	201.6	-1.7	0.0	0.0	0.0	0.0	-0.0	-220.0	-220.0

Point Source, ISO 9613, Name: "Em_Trans6", ID: "Em_Trans6"																			
Nr.	X	Y	Z	Refl.	Freq.	LxT	LxN	K0	Dc	Adiv	Aatm	Agr	Afol	Ahous	Abar	Cmet	RL	LrT	LrN
	(m)	(m)	(m)		(Hz)	dB(A)	dB(A)	(dB)	(dB)	(dB)	(dB)	(dB)	(dB)	(dB)	(dB)	(dB)	(dB)	dB(A)	dB(A)
1	500503.60	5441900.51	2.58	0	32	37.3	37.3	0.0	0.0	76.3	0.1	-5.8	0.0	0.0	0.0	0.0	-0.0	-33.2	-33.2
2	500503.60	5441900.51	2.58	0	63	56.5	56.5	0.0	0.0	76.3	0.2	-5.8	0.0	0.0	0.0	0.0	-0.0	-14.2	-14.2
3	500503.60	5441900.51	2.58	0	125	68.6	68.6	0.0	0.0	76.3	0.8	5.2	0.0	0.0	0.0	0.0	-0.0	-13.7	-13.7
4	500503.60	5441900.51	2.58	0	250	71.1	71.1	0.0	0.0	76.3	1.9	6.5	0.0	0.0	0.0	0.0	-0.0	-13.6	-13.6
5	500503.60	5441900.51	2.58	0	500	76.5	76.5	0.0	0.0	76.3	3.5	2.2	0.0	0.0	0.0	0.0	-0.0	-5.5	-5.5
6	500503.60	5441900.51	2.58	0	1000	73.7	73.7	0.0	0.0	76.3	6.7	-1.3	0.0	0.0	0.0	0.0	-0.0	-8.0	-8.0
7	500503.60	5441900.51	2.58	0	2000	69.9	69.9	0.0	0.0	76.3	17.8	-1.7	0.0	0.0	0.0	0.0	-0.0	-22.4	-22.4
8	500503.60	5441900.51	2.58	0	4000	64.7	64.7	0.0	0.0	76.3	60.2	-1.7	0.0	0.0	0.0	0.0	-0.0	-70.1	-70.1
9	500503.60	5441900.51	2.58	0	8000	55.6	55.6	0.0	0.0	76.3	214.8	-1.7	0.0	0.0	0.0	0.0	-0.0	-233.7	-233.7

Point Source, ISO 9613, Name: "Em_Trans7", ID: "Em_Trans7"																			
Nr.	X	Y	Z	Refl.	Freq.	LxT	LxN	K0	Dc	Adiv	Aatm	Agr	Afol	Ahous	Abar	Cmet	RL	LrT	LrN
	(m)	(m)	(m)		(Hz)	dB(A)	dB(A)	(dB)	(dB)	(dB)	(dB)	(dB)	(dB)	(dB)	(dB)	(dB)	(dB)	dB(A)	dB(A)
1	500503.60	5442057.31	2.58	0	32	37.3	37.3	0.0	0.0	75.5	0.1	-5.8	0.0	0.0	0.0	0.0	-0.0	-32.5	-32.5
2	500503.60	5442057.31	2.58	0	63	56.5	56.5	0.0	0.0	75.5	0.2	-5.8	0.0	0.0	0.0	0.0	-0.0	-13.5	-13.5
3	500503.60	5442057.31	2.58	0	125	68.6	68.6	0.0	0.0	75.5	0.7	5.2	0.0	0.0	0.0	0.0	-0.0	-12.9	-12.9
4	500503.60	5442057.31	2.58	0	250	71.1	71.1	0.0	0.0	75.5	1.8	6.5	0.0	0.0	0.0	0.0	-0.0	-12.7	-12.7
5	500503.60	5442057.31	2.58	0	500	76.5	76.5	0.0	0.0	75.5	3.3	2.2	0.0	0.0	0.0	0.0	-0.0	-4.5	-4.5
6	500503.60	5442057.31	2.58	0	1000	73.7	73.7	0.0	0.0	75.5	6.2	-1.3	0.0	0.0	0.0	0.0	-0.0	-6.8	-6.8
7	500503.60	5442057.31	2.58	0	2000	69.9	69.9	0.0	0.0	75.5	16.3	-1.7	0.0	0.0	0.0	0.0	-0.0	-20.2	-20.2
8	500503.60	5442057.31	2.58	0	4000	64.7	64.7	0.0	0.0	75.5	55.3	-1.7	0.0	0.0	0.0	0.0	-0.0	-64.4	-64.4
9	500503.60	5442057.31	2.58	0	8000	55.6	55.6	0.0	0.0	75.5	197.3	-1.7	0.0	0.0	0.0	0.0	-0.0	-215.5	-215.5

Point Source, ISO 9613, Name: "Em_Trans8", ID: "Em_Trans8"																			
Nr.	X	Y	Z	Refl.	Freq.	LxT	LxN	K0	Dc	Adiv	Aatm	Agr	Afol	Ahous	Abar	Cmet	RL	LrT	LrN
	(m)	(m)	(m)		(Hz)	dB(A)	dB(A)	(dB)	(dB)	(dB)	(dB)	(dB)	(dB)	(dB)	(dB)	(dB)	(dB)	dB(A)	dB(A)
1	500467.40	5442281.31	2.58	0	32	37.3	37.3	0.0	0.0	74.5	0.1	-5.8	0.0	0.0	0.0	0.0	-0.0	-31.5	-31.5
2	500467.40	5442281.31	2.58	0	63	56.5	56.5	0.0	0.0	74.5	0.2	-5.8	0.0	0.0	0.0	0.0	-0.0	-12.4	-12.4
3	500467.40	5442281.31	2.58	0	125	68.6	68.6	0.0	0.0	74.5	0.6	5.2	0.0	0.0	0.0	0.0	-0.0	-11.7	-11.7
4	500467.40	5442281.31	2.58	0	250	71.1	71.1	0.0	0.0	74.5	1.6	6.5	0.0	0.0	0.0	0.0	-0.0	-11.4	-11.4
5	500467.40	5442281.31	2.58	0	500	76.5	76.5	0.0	0.0	74.5	2.9	2.2	0.0	0.0	0.0	0.0	-0.0	-3.1	-3.1
6	500467.40	5442281.31	2.58	0	1000	73.7	73.7	0.0	0.0	74.5	5.5	-1.3	0.0	0.0	0.0	0.0	-0.0	-5.0	-5.0
7	500467.40	5442281.31	2.58	0	2000	69.9	69.9	0.0	0.0	74.5	14.4	-1.7	0.0	0.0	0.0	0.0	-0.0	-17.3	-17.3
8	500467.40	5442281.31	2.58	0	4000	64.7	64.7	0.0	0.0	74.5	48.9	-1.7	0.0	0.0	0.0	0.0	-0.0	-56.9	-56.9
9	500467.40	5442281.31	2.58	0	8000	55.6	55.6	0.0	0.0	74.5	174.3	-1.7	0.0	0.0	0.0	0.0	-0.0	-191.5	-191.5

Point Source, ISO 9613, Name: "Em_Trans9", ID: "Em_Trans9"																			
Nr.	X	Y	Z	Refl.	Freq.	LxT	LxN	K0	Dc	Adiv	Aatm	Agr	Afol	Ahous	Abar	Cmet	RL	LrT	LrN
	(m)	(m)	(m)		(Hz)	dB(A)	dB(A)	(dB)	(dB)	(dB)	(dB)	(dB)	(dB)	(dB)	(dB)	(dB)	(dB)	dB(A)	dB(A)
1	500646.43	5442281.31	2.58	0	32	37.3	37.3	0.0	0.0	74.1	0.1	-5.7	0.0	0.0	0.0	0.0	-0.0	-31.1	-31.1
2	500646.43	5442281.31	2.58	0	63	56.5	56.5	0.0	0.0	74.1	0.2	-5.7	0.0	0.0	0.0	0.0	-0.0	-12.1	-12.1
3	500646.43	5442281.31	2.58	0	125	68.6	68.6	0.0	0.0	74.1	0.6	5.2	0.0	0.0	0.0	0.0	-0.0	-11.3	-11.3
4	500646.43	5442281.31	2.58	0	250	71.1	71.1	0.0	0.0	74.1	1.5	6.5	0.0	0.0	0.0	0.0	-0.0	-11.0	-11.0
5	500646.43	5442281.31	2.58	0	500	76.5	76.5	0.0	0.0	74.1	2.8	2.2	0.0	0.0	0.0	0.0	-0.0	-2.6	-2.6
6	500646.43	5442281.31	2.58	0	1000	73.7	73.7	0.0	0.0	74.1	5.2	-1.3	0.0	0.0	0.0	0.0	-0.0	-4.4	-4.4
7	500646.43	5442281.31	2.58	0	2000	69.9	69.9	0.0	0.0	74.1	13.8	-1.7	0.0	0.0	0.0	0.0	-0.0	-16.3	-16.3
8	500646.43	5442281.31	2.58	0	4000	64.7	64.7	0.0	0.0	74.1	46.9	-1.7	0.0	0.0	0.0	0.0	-0.0	-54.6	-54.6
9	500646.43	5442281.31	2.58	0	8000	55.6	55.6	0.0	0.0	74.1	167.3	-1.7	0.0	0.0	0.0	0.0	-0.0	-184.1	-184.1

Point Source, ISO 9613, Name: "Em_Trans10", ID: "Em_Trans10"																			
Nr.	X	Y	Z	Refl.	Freq.	LxT	LxN	K0	Dc	Adiv	Aatm	Agr	Afol	Ahous	Abar	Cmet	RL	LrT	LrN
	(m)	(m)	(m)		(Hz)	dB(A)	dB(A)	(dB)	(dB)	(dB)	(dB)	(dB)	(dB)	(dB)	(dB)	(dB)	(dB)	dB(A)	dB(A)
1	499998.21	5441665.31	2.58	0	32	37.3	37.3	0.0	0.0	78.0	0.1	-5.8	0.0	0.0	0.0	0.0	-0.0	-35.0	-35.0
2	499998.21	5441665.31	2.58	0	63	56.5	56.5	0.0	0.0	78.0	0.3	-5.8	0.0	0.0	0.0	0.0	-0.0	-16.0	-16.0
3	499998.21	5441665.31	2.58	0	125	68.6	68.6	0.0	0.0	78.0	0.9	5.2	0.0	0.0	0.0	0.0	-0.0	-15.6	-15.6
4	499998.21	5441665.31	2.58	0	250	71.1	71.1	0.0	0.0	78.0	2.3	6.5	0.0	0.0	0.0	0.0	-0.0	-15.8	-15.8
5	499998.21	5441665.31	2.58	0	500	76.5	76.5	0.0	0.0	78.0	4.3	2.2	0.0	0.0	0.0	0.0	-0.0	-8.1	-8.1
6	499998.21	5441665.31	2.58	0	1000	73.7	73.7	0.0	0.0	78.0	8.2	-1.3	0.0	0.0	0.0	0.0	-0.0	-11.3	-11.3
7	499998.21	5441665.31	2.58	0	2000	69.9	69.9	0.0	0.0	78.0	21.7	-1.8	0.0	0.0	0.0	0.0	-0.0	-28.1	-28.1
8	499998.21	5441665.31	2.58	0	4000	64.7	64.7	0.0	0.0	78.0	73.7	-1.8	0.0	0.0	0.0	0.0	-0.0	-85.3	-85.3
9	499998.21	5441665.31	2.58	0	8000	55.6	55.6	0.0	0.0	78.0	262.9	-1.8	0.0	0.0	0.0	0.0	-0.0	-283.6	-283.6

Point Source, ISO 9613, Name: "Em_Trans11", ID: "Em_Trans11"																			
Nr.	X	Y	Z	Refl.	Freq.	LxT	LxN	K0	Dc	Adiv	Aatm	Agr	Afol	Ahous	Abar	Cmet	RL	LrT	LrN
	(m)	(m)	(m)		(Hz)	dB(A)	dB(A)	(dB)	(dB)	(dB)	(dB)	(dB)	(dB)	(dB)	(dB)	(dB)	(dB)	dB(A)	dB(A)
1	499998.21	5441505.21	2.58	0	32	37.3	37.3	0.0	0.0	78.6	0.1	-5.8	0.0	0.0	0.0	0.0	-0.0	-35.5	-35.5
2	499998.21	5441505.21	2.58	0	63	56.5	56.5	0.0	0.0	78.6	0.3	-5.8	0.0	0.0	0.0	0.0	-0.0	-16.5	-16.5
3	499998.21	5441505.21	2.58	0	125	68.6	68.6	0.0	0.0	78.6	1.0	5.2	0.0	0.0	0.0	0.0	-0.0	-16.2	-16.2
4	499998.21	5441505.21	2.58	0	250	71.1	71.1	0.0	0.0	78.6	2.5	6.5	0.0	0.0	0.0	0.0	-0.0	-16.4	-16.4
5	499998.21	5441505.21	2.58	0	500	76.5	76.5	0.0	0.0	78.6	4.6	2.2	0.0	0.0	0.0	0.0	-0.0	-8.9	-8.9
6	499998.21	5441505.21	2.58	0	1000	73.7	73.7	0.0	0.0	78.6	8.8	-1.3	0.0	0.0	0.0	0.0	-0.0	-12.3	-12.3
7	499998.21	5441505.21	2.58	0	2000	69.9	69.9	0.0	0.0	78.6	23.1	-1.8	0.0	0.0	0.0	0.0	-0.0	-30.0	-30.0
8	499998.21	5441505.21	2.58	0	4000	64.7	64.7	0.0	0.0	78.6	78.4	-1.8	0.0	0.0	0.0	0.0	-0.0	-90.5	-90.5
9	499998.21	5441505.21	2.58	0	8000	55.6	55.6	0.0	0.0	78.6	279.6	-1.8	0.0	0.0	0.0	0.0	-0.0	-300.9	-300.9

Point Source, ISO 9613, Name: "MM_Sub115", ID: "MM_Sub115"																			
Nr.	X	Y	Z	Refl.	Freq.	LxT	LxN	K0	Dc	Adiv	Aatm	Agr	Afol	Ahous	Abar	Cmet	RL	LrT	LrN
	(m)	(m)	(m)		(Hz)	dB(A)	dB(A)	(dB)	(dB)	(dB)	(dB)	(dB)	(dB)	(dB)	(dB)	(dB)	(dB)	dB(A)	dB(A)
1	500993.61	5443521.27	3.60	0	32	43.3	43.3	0.0	0.0	54.2	0.0	-3.0	0.0	0.0	0.0	0.0	-0.0	-7.9	-7.9
2	500993.61	5443521.27	3.60	0	63	60.5	60.5	0.0	0.0	54.2	0.0	-3.0	0.0	0.0	0.0	0.0	-0.0	9.3	9.3
3	500993.61	5443521.27	3.60	0	125	73.6	73.6	0.0	0.0	54.2	0.1	1.4	0.0	0.0	0.0	0.0	-0.0	18.0	18.0
4	500993.61	5443521.27	3.60	0	250	79.1	79.1	0.0	0.0	54.2	0.2	5.5	0.0	0.0	0.0	0.0	-0.0	19.2	19.2
5	500993.61	5443521.27	3.60	0	500	84.5	84.5	0.0	0.0	54.2	0.3	2.4	0.0	0.0	0.0	0.0	-0.0	27.6	27.6
6	500993.61	5443521.27	3.60	0	1000	81.7	81.7	0.0	0.0	54.2	0.5	-0.5	0.0	0.0	0.0	0.0	-0.0	27.4	27.4
7	500993.61	5443521.27	3.60	0	2000	77.9	77.9	0.0	0.0	54.2	1.4	-0.9	0.0	0.0	0.0	0.0	-0.0	23.2	23.2
8	500993.61	5443521.27	3.60	0	4000	72.7	72.7	0.0	0.0	54.2	4.7	-0.9	0.0	0.0	0.0	0.0	-0.0	14.7	14.7
9	500993.61	5443521.27	3.60	0	8000	62.6	62.6	0.0	0.0	54.2	16.9	-0.9	0.0	0.0	0.0	0.0	-0.0	-7.6	-7.6

Point Source, ISO 9613, Name: "MM_Inv1", ID: "MM_Inv1"																			
Nr.	X	Y	Z	Refl.	Freq.	LxT	LxN	K0	Dc	Adiv	Aatm	Agr	Afol	Ahous	Abar	Cmet	RL	LrT	LrN
	(m)	(m)	(m)		(Hz)	dB(A)	dB(A)	(dB)	(dB)	(dB)	(dB)	(dB)	(dB)	(dB)	(dB)	(dB)	(dB)	dB(A)	dB(A)
1	501222.00	5443157.66	2.60	0	63	68.1	68.1	0.0	0.0	65.5	0.1	-5.3	0.0	0.0	0.0	0.0	-0.0	7.9	7.9
2	501222.00	5443157.66	2.60	0	125	78.9	78.9	0.0	0.0	65.5	0.2	2.9	0.0	0.0	0.0	0.0	-0.0	10.3	10.3
3	501222.00	5443157.66	2.60	0	250	85.5	85.5	0.0	0.0	65.5	0.6	6.6	0.0	0.0	0.0	0.0	-0.0	12.9	12.9
4	501222.00	5443157.66	2.60	0	500	87.3	87.3	0.0	0.0	65.5	1.0	2.3	0.0	0.0	0.0	0.0	-0.0	18.5	18.5
5	501222.00	5443157.66	2.60	0	1000	83.7	83.7	0.0	0.0	65.5	1.9	-1.1	0.0	0.0	0.0	0.0	-0.0	17.4	17.4
6	501222.00	5443157.66	2.60	0	2000	79.1	79.1	0.0	0.0	65.5	5.1	-1.6	0.0	0.0	0.0	0.0	-0.0	10.1	10.1
7	501222.00	5443157.66	2.60	0	4000	70.0	70.0	0.0	0.0	65.5	17.3	-1.6	0.0	0.0	0.0	0.0	-0.0	-11.2	-11.2
8	501222.00	5443157.66	2.60	0	8000	77.7	77.7	0.0	0.0	65.5	61.9	-1.6	0.0	0.0	0.0	0.0	-0.0	-48.0	-48.0

Point Source, ISO 9613, Name: "MM_Inv2", ID: "MM_Inv2"																			
Nr.	X	Y	Z	Refl.	Freq.	LxT	LxN	K0	Dc	Adiv	Aatm	Agr	Afol	Ahous	Abar	Cmet	RL	LrT	LrN
	(m)	(m)	(m)		(Hz)	dB(A)	dB(A)	(dB)	(dB)	(dB)	(dB)	(dB)	(dB)	(dB)	(dB)	(dB)	(dB)	dB(A)	dB(A)
1	501240.10	5442978.46	2.60	0	63	68.1	68.1	0.0	0.0	68.0	0.1	-5.5	0.0	0.0	0.0	0.0	-0.0	5.5	5.5
2	501240.10	5442978.46	2.60	0	125	78.9	78.9	0.0	0.0	68.0	0.3	4.0	0.0	0.0	0.0	0.0	-0.0	6.7	6.7
3	501240.10	5442978.46	2.60	0	250	85.5	85.5	0.0	0.0	68.0	0.7	6.5	0.0	0.0	0.0	0.0	-0.0	10.2	10.2
4	501240.10	5442978.46	2.60	0	500	87.3	87.3	0.0	0.0	68.0	1.4	2.3	0.0	0.0	0.0	0.0	-0.0	15.7	15.7
5	501240.10	5442978.46	2.60	0	1000	83.7	83.7	0.0	0.0	68.0	2.6	-1.2	0.0	0.0	0.0	0.0	-0.0	14.3	14.3
6	501240.10	5442978.46	2.60	0	2000	79.1	79.1	0.0	0.0	68.0	6.8	-1.6	0.0	0.0	0.0	0.0	-0.0	6.0	6.0
7	501240.10	5442978.46	2.60	0	4000	70.0	70.0	0.0	0.0	68.0	23.1	-1.6	0.0	0.0	0.0	0.0	-0.0	-19.4	-19.4
8	501240.10	5442978.46	2.60	0	8000	77.7	77.7	0.0	0.0	68.0	82.5	-1.6	0.0	0.0	0.0	0.0	-0.0	-71.1	-71.1

Point Source, ISO 9613, Name: "MM_Inv3", ID: "MM_Inv3"																			
Nr.	X	Y	Z	Refl.	Freq.	LxT	LxN	K0	Dc	Adiv	Aatm	Agr	Afol	Ahous	Abar	Cmet	RL	LrT	LrN
	(m)	(m)	(m)		(Hz)	dB(A)	dB(A)	(dB)	(dB)	(dB)	(dB)	(dB)	(dB)	(dB)	(dB)	(dB)	(dB)	dB(A)	dB(A)
1	501240.10	5442776.86	2.60	0	63	68.1	68.1	0.0	0.0	70.1	0.1	-5.6	0.0	0.0	0.0	0.0	-0.0	3.5	3.5
2	501240.10	5442776.86	2.60	0	125	78.9	78.9	0.0	0.0	70.1	0.4	4.7	0.0	0.0	0.0	0.0	-0.0	3.7	3.7
3	501240.10	5442776.86	2.60	0	250	85.5	85.5	0.0	0.0	70.1	0.9	6.5	0.0	0.0	0.0	0.0	-0.0	8.0	8.0
4	501240.10	5442776.86	2.60	0	500	87.3	87.3	0.0	0.0	70.1	1.7	2.2	0.0	0.0	0.0	0.0	-0.0	13.2	13.2
5	501240.10	5442776.86	2.60	0	1000	83.7	83.7	0.0	0.0	70.1	3.3	-1.2	0.0	0.0	0.0	0.0	-0.0	11.5	11.5
6	501240.10	5442776.86	2.60	0	2000	79.1	79.1	0.0	0.0	70.1	8.7	-1.7	0.0	0.0	0.0	0.0	-0.0	2.0	2.0
7	501240.10	5442776.86	2.60	0	4000	70.0	70.0	0.0	0.0	70.1	29.5	-1.7	0.0	0.0	0.0	0.0	-0.0	-27.9	-27.9
8	501240.10	5442776.86	2.60	0	8000	77.7	77.7	0.0	0.0	70.1	105.3	-1.7	0.0	0.0	0.0	0.0	-0.0	-96.0	-96.0

Point Source, ISO 9613, Name: "MM_Inv4", ID: "MM_Inv4"																			
Nr.	X	Y	Z	Refl.	Freq.	LxT	LxN	K0	Dc	Adiv	Aatm	Agr	Afol	Ahous	Abar	Cmet	RL	LrT	LrN
	(m)	(m)	(m)		(Hz)	dB(A)	dB(A)	(dB)	(dB)	(dB)	(dB)	(dB)	(dB)	(dB)	(dB)	(dB)	(dB)	dB(A)	dB(A)
1	501240.10	5442575.26	2.60	0	63	68.1	68.1	0.0	0.0	71.8	0.1	-5.7	0.0	0.0	0.0	0.0	-0.0	1.8	1.8
2	501240.10	5442575.26	2.60	0	125	78.9	78.9	0.0	0.0	71.8	0.5	5.1	0.0	0.0	0.0	0.0	-0.0	1.6	1.6
3	501240.10	5442575.26	2.60	0	250	85.5	85.5	0.0	0.0	71.8	1.2	6.5	0.0	0.0	0.0	0.0	-0.0	6.0	6.0
4	501240.10	5442575.26	2.60	0	500	87.3	87.3	0.0	0.0	71.8	2.1	2.2	0.0	0.0	0.0	0.0	-0.0	11.2	11.2
5	501240.10	5442575.26	2.60	0	1000	83.7	83.7	0.0	0.0	71.8	4.0	-1.2	0.0	0.0	0.0	0.0	-0.0	9.1	9.1
6	501240.10	5442575.26	2.60	0	2000	79.1	79.1	0.0	0.0	71.8	10.6	-1.7	0.0	0.0	0.0	0.0	-0.0	-1.6	-1.6
7	501240.10	5442575.26	2.60	0	4000	70.0	70.0	0.0	0.0	71.8	36.0	-1.7	0.0	0.0	0.0	0.0	-0.0	-36.1	-36.1
8	501240.10	5442575.26	2.60	0	8000	77.7	77.7	0.0	0.0	71.8	128.4	-1.7	0.0	0.0	0.0	0.0	-0.0	-120.8	-120.8

Point Source, ISO 9613, Name: "MM_Inv5", ID: "MM_Inv5"																			
Nr.	X	Y	Z	Refl.	Freq.	LxT	LxN	K0	Dc	Adiv	Aatm	Agr	Afol	Ahous	Abar	Cmet	RL	LrT	LrN
	(m)	(m)	(m)		(Hz)	dB(A)	dB(A)	(dB)	(dB)	(dB)	(dB)	(dB)	(dB)	(dB)	(dB)	(dB)	(dB)	dB(A)	dB(A)
1	500977.67	5442553.91	2.60	0	63	68.1	68.1	0.0	0.0	71.9	0.1	-5.7	0.0	0.0	0.0	0.0	-0.0	1.8	1.8
2	500977.67	5442553.91	2.60	0	125	78.9	78.9	0.0	0.0	71.9	0.5	5.1	0.0	0.0	0.0	0.0	-0.0	1.5	1.5
3	500977.67	5442553.91	2.60	0	250	85.5	85.5	0.0	0.0	71.9	1.2	6.5	0.0	0.0	0.0	0.0	-0.0	6.0	6.0
4	500977.67	5442553.91	2.60	0	500	87.3	87.3	0.0	0.0	71.9	2.1	2.2	0.0	0.0	0.0	0.0	-0.0	11.1	11.1
5	500977.67	5442553.91	2.60	0	1000	83.7	83.7	0.0	0.0	71.9	4.0	-1.2	0.0	0.0	0.0	0.0	-0.0	9.0	9.0
6	500977.67	5442553.91	2.60	0	2000	79.1	79.1	0.0	0.0	71.9	10.7	-1.7	0.0	0.0	0.0	0.0	-0.0	-1.7	-1.7
7	500977.67	5442553.91	2.60	0	4000	70.0	70.0	0.0	0.0	71.9	36.2	-1.7	0.0	0.0	0.0	0.0	-0.0	-36.4	-36.4
8	500977.67	5442553.91	2.60	0	8000	77.7	77.7	0.0	0.0	71.9	129.1	-1.7	0.0	0.0	0.0	0.0	-0.0	-121.6	-121.6

Point Source, ISO 9613, Name: "MM_Inv6", ID: "MM_Inv6"																			
Nr.	X	Y	Z	Refl.	Freq.	LxT	LxN	K0	Dc	Adiv	Aatm	Agr	Afol	Ahous	Abar	Cmet	RL	LrT	LrN
	(m)	(m)	(m)		(Hz)	dB(A)	dB(A)	(dB)	(dB)	(dB)	(dB)	(dB)	(dB)	(dB)	(dB)	(dB)	(dB)	dB(A)	dB(A)
1	500977.67	5442755.51	2.60	0	63	68.1	68.1	0.0	0.0	70.1	0.1	-5.6	0.0	0.0	0.0	0.0	-0.0	3.5	3.5
2	500977.67	5442755.51	2.60	0	125	78.9	78.9	0.0	0.0	70.1	0.4	4.7	0.0	0.0	0.0	0.0	-0.0	3.7	3.7
3	500977.67	5442755.51	2.60	0	250	85.5	85.5	0.0	0.0	70.1	0.9	6.5	0.0	0.0	0.0	0.0	-0.0	7.9	7.9
4	500977.67	5442755.51	2.60	0	500	87.3	87.3	0.0	0.0	70.1	1.7	2.2	0.0	0.0	0.0	0.0	-0.0	13.2	13.2
5	500977.67	5442755.51	2.60	0	1000	83.7	83.7	0.0	0.0	70.1	3.3	-1.2	0.0	0.0	0.0	0.0	-0.0	11.5	11.5
6	500977.67	5442755.51	2.60	0	2000	79.1	79.1	0.0	0.0	70.1	8.7	-1.7	0.0	0.0	0.0	0.0	-0.0	1.9	1.9
7	500977.67	5442755.51	2.60	0	4000	70.0	70.0	0.0	0.0	70.1	29.6	-1.7	0.0	0.0	0.0	0.0	-0.0	-28.1	-28.1
8	500977.67	5442755.51	2.60	0	8000	77.7	77.7	0.0	0.0	70.1	105.6	-1.7	0.0	0.0	0.0	0.0	-0.0	-96.3	-96.3

Point Source, ISO 9613, Name: "MM_Inv7", ID: "MM_Inv7"																			
Nr.	X	Y	Z	Refl.	Freq.	LxT	LxN	K0	Dc	Adiv	Aatm	Agr	Afol	Ahous	Abar	Cmet	RL	LrT	LrN
	(m)	(m)	(m)		(Hz)	dB(A)	dB(A)	(dB)	(dB)	(dB)	(dB)	(dB)	(dB)	(dB)	(dB)	(dB)	(dB)	dB(A)	dB(A)
1	500977.67	5442957.06	2.60	0	63	68.1	68.1	0.0	0.0	67.9	0.1	-5.5	0.0	0.0	0.0	0.0	-0.0	5.6	5.6
2	500977.67	5442957.06	2.60	0	125	78.9	78.9	0.0	0.0	67.9	0.3	4.0	0.0	0.0	0.0	0.0	-0.0	6.7	6.7
3	500977.67	5442957.06	2.60	0	250	85.5	85.5	0.0	0.0	67.9	0.7	6.5	0.0	0.0	0.0	0.0	-0.0	10.3	10.3

Point Source, ISO 9613, Name: "MM_Inv7", ID: "MM_Inv7"																			
Nr.	X	Y	Z	Refl.	Freq.	LxT	LxN	K0	Dc	Adiv	Aatm	Agr	Afol	Ahous	Abar	Cmet	RL	LrT	LrN
	(m)	(m)	(m)		(Hz)	dB(A)	dB(A)	(dB)	(dB)	(dB)	(dB)	(dB)	(dB)	(dB)	(dB)	(dB)	(dB)	dB(A)	dB(A)
4	500977.67	5442957.06	2.60	0	500	87.3	87.3	0.0	0.0	67.9	1.4	2.3	0.0	0.0	0.0	0.0	-0.0	15.7	15.7
5	500977.67	5442957.06	2.60	0	1000	83.7	83.7	0.0	0.0	67.9	2.6	-1.2	0.0	0.0	0.0	0.0	-0.0	14.4	14.4
6	500977.67	5442957.06	2.60	0	2000	79.1	79.1	0.0	0.0	67.9	6.8	-1.6	0.0	0.0	0.0	0.0	-0.0	6.0	6.0
7	500977.67	5442957.06	2.60	0	4000	70.0	70.0	0.0	0.0	67.9	23.0	-1.6	0.0	0.0	0.0	0.0	-0.0	-19.3	-19.3
8	500977.67	5442957.06	2.60	0	8000	77.7	77.7	0.0	0.0	67.9	82.1	-1.6	0.0	0.0	0.0	0.0	-0.0	-70.7	-70.7

Point Source, ISO 9613, Name: "MM_Trans1", ID: "MM_Trans1"																			
Nr.	X	Y	Z	Refl.	Freq.	LxT	LxN	K0	Dc	Adiv	Aatm	Agr	Afol	Ahous	Abar	Cmet	RL	LrT	LrN
	(m)	(m)	(m)		(Hz)	dB(A)	dB(A)	(dB)	(dB)	(dB)	(dB)	(dB)	(dB)	(dB)	(dB)	(dB)	(dB)	dB(A)	dB(A)
1	501216.50	5443158.16	2.58	0	32	37.3	37.3	0.0	0.0	65.4	0.0	-5.3	0.0	0.0	0.0	0.0	-0.0	-22.9	-22.9
2	501216.50	5443158.16	2.58	0	63	56.5	56.5	0.0	0.0	65.4	0.1	-5.3	0.0	0.0	0.0	0.0	-0.0	-3.7	-3.7
3	501216.50	5443158.16	2.58	0	125	68.6	68.6	0.0	0.0	65.4	0.2	2.9	0.0	0.0	0.0	0.0	-0.0	0.1	0.1
4	501216.50	5443158.16	2.58	0	250	71.1	71.1	0.0	0.0	65.4	0.6	6.6	0.0	0.0	0.0	0.0	-0.0	-1.5	-1.5
5	501216.50	5443158.16	2.58	0	500	76.5	76.5	0.0	0.0	65.4	1.0	2.3	0.0	0.0	0.0	0.0	-0.0	7.7	7.7
6	501216.50	5443158.16	2.58	0	1000	73.7	73.7	0.0	0.0	65.4	1.9	-1.1	0.0	0.0	0.0	0.0	-0.0	7.5	7.5
7	501216.50	5443158.16	2.58	0	2000	69.9	69.9	0.0	0.0	65.4	5.1	-1.6	0.0	0.0	0.0	0.0	-0.0	1.0	1.0
8	501216.50	5443158.16	2.58	0	4000	64.7	64.7	0.0	0.0	65.4	17.3	-1.6	0.0	0.0	0.0	0.0	-0.0	-16.4	-16.4
9	501216.50	5443158.16	2.58	0	8000	55.6	55.6	0.0	0.0	65.4	61.6	-1.6	0.0	0.0	0.0	0.0	-0.0	-69.8	-69.8

Point Source, ISO 9613, Name: "MM_Trans2", ID: "MM_Trans2"																			
Nr.	X	Y	Z	Refl.	Freq.	LxT	LxN	K0	Dc	Adiv	Aatm	Agr	Afol	Ahous	Abar	Cmet	RL	LrT	LrN
	(m)	(m)	(m)		(Hz)	dB(A)	dB(A)	(dB)	(dB)	(dB)	(dB)	(dB)	(dB)	(dB)	(dB)	(dB)	(dB)	dB(A)	dB(A)
1	501234.60	5442978.96	2.58	0	32	37.3	37.3	0.0	0.0	68.0	0.0	-5.5	0.0	0.0	0.0	0.0	-0.0	-25.2	-25.2
2	501234.60	5442978.96	2.58	0	63	56.5	56.5	0.0	0.0	68.0	0.1	-5.5	0.0	0.0	0.0	0.0	-0.0	-6.0	-6.0
3	501234.60	5442978.96	2.58	0	125	68.6	68.6	0.0	0.0	68.0	0.3	4.0	0.0	0.0	0.0	0.0	-0.0	-3.6	-3.6
4	501234.60	5442978.96	2.58	0	250	71.1	71.1	0.0	0.0	68.0	0.7	6.6	0.0	0.0	0.0	0.0	-0.0	-4.2	-4.2
5	501234.60	5442978.96	2.58	0	500	76.5	76.5	0.0	0.0	68.0	1.4	2.3	0.0	0.0	0.0	0.0	-0.0	4.9	4.9
6	501234.60	5442978.96	2.58	0	1000	73.7	73.7	0.0	0.0	68.0	2.6	-1.2	0.0	0.0	0.0	0.0	-0.0	4.3	4.3
7	501234.60	5442978.96	2.58	0	2000	69.9	69.9	0.0	0.0	68.0	6.8	-1.6	0.0	0.0	0.0	0.0	-0.0	-3.2	-3.2
8	501234.60	5442978.96	2.58	0	4000	64.7	64.7	0.0	0.0	68.0	23.1	-1.6	0.0	0.0	0.0	0.0	-0.0	-24.7	-24.7
9	501234.60	5442978.96	2.58	0	8000	55.6	55.6	0.0	0.0	68.0	82.2	-1.6	0.0	0.0	0.0	0.0	-0.0	-92.9	-92.9

Point Source, ISO 9613, Name: "MM_Trans3", ID: "MM_Trans3"																			
Nr.	X	Y	Z	Refl.	Freq.	LxT	LxN	K0	Dc	Adiv	Aatm	Agr	Afol	Ahous	Abar	Cmet	RL	LrT	LrN
	(m)	(m)	(m)		(Hz)	dB(A)	dB(A)	(dB)	(dB)	(dB)	(dB)	(dB)	(dB)	(dB)	(dB)	(dB)	(dB)	dB(A)	dB(A)
1	501234.60	5442777.36	2.58	0	32	37.3	37.3	0.0	0.0	70.1	0.0	-5.6	0.0	0.0	0.0	0.0	-0.0	-27.2	-27.2
2	501234.60	5442777.36	2.58	0	63	56.5	56.5	0.0	0.0	70.1	0.1	-5.6	0.0	0.0	0.0	0.0	-0.0	-8.1	-8.1
3	501234.60	5442777.36	2.58	0	125	68.6	68.6	0.0	0.0	70.1	0.4	4.7	0.0	0.0	0.0	0.0	-0.0	-6.6	-6.6
4	501234.60	5442777.36	2.58	0	250	71.1	71.1	0.0	0.0	70.1	0.9	6.5	0.0	0.0	0.0	0.0	-0.0	-6.5	-6.5
5	501234.60	5442777.36	2.58	0	500	76.5	76.5	0.0	0.0	70.1	1.7	2.3	0.0	0.0	0.0	0.0	-0.0	2.4	2.4
6	501234.60	5442777.36	2.58	0	1000	73.7	73.7	0.0	0.0	70.1	3.3	-1.2	0.0	0.0	0.0	0.0	-0.0	1.5	1.5
7	501234.60	5442777.36	2.58	0	2000	69.9	69.9	0.0	0.0	70.1	8.7	-1.7	0.0	0.0	0.0	0.0	-0.0	-7.2	-7.2
8	501234.60	5442777.36	2.58	0	4000	64.7	64.7	0.0	0.0	70.1	29.5	-1.7	0.0	0.0	0.0	0.0	-0.0	-33.2	-33.2
9	501234.60	5442777.36	2.58	0	8000	55.6	55.6	0.0	0.0	70.1	105.1	-1.7	0.0	0.0	0.0	0.0	-0.0	-117.9	-117.9

Point Source, ISO 9613, Name: "MM_Trans4", ID: "MM_Trans4"																			
Nr.	X	Y	Z	Refl.	Freq.	LxT	LxN	K0	Dc	Adiv	Aatm	Agr	Afol	Ahous	Abar	Cmet	RL	LrT	LrN
	(m)	(m)	(m)		(Hz)	dB(A)	dB(A)	(dB)	(dB)	(dB)	(dB)	(dB)	(dB)	(dB)	(dB)	(dB)	(dB)	dB(A)	dB(A)
1	501234.60	5442575.76	2.58	0	32	37.3	37.3	0.0	0.0	71.8	0.0	-5.7	0.0	0.0	0.0	0.0	-0.0	-28.9	-28.9
2	501234.60	5442575.76	2.58	0	63	56.5	56.5	0.0	0.0	71.8	0.1	-5.7	0.0	0.0	0.0	0.0	-0.0	-9.8	-9.8
3	501234.60	5442575.76	2.58	0	125	68.6	68.6	0.0	0.0	71.8	0.5	5.1	0.0	0.0	0.0	0.0	-0.0	-8.7	-8.7
4	501234.60	5442575.76	2.58	0	250	71.1	71.1	0.0	0.0	71.8	1.1	6.5	0.0	0.0	0.0	0.0	-0.0	-8.4	-8.4
5	501234.60	5442575.76	2.58	0	500	76.5	76.5	0.0	0.0	71.8	2.1	2.2	0.0	0.0	0.0	0.0	-0.0	0.3	0.3
6	501234.60	5442575.76	2.58	0	1000	73.7	73.7	0.0	0.0	71.8	4.0	-1.2	0.0	0.0	0.0	0.0	-0.0	-0.9	-0.9
7	501234.60	5442575.76	2.58	0	2000	69.9	69.9	0.0	0.0	71.8	10.6	-1.7	0.0	0.0	0.0	0.0	-0.0	-10.8	-10.8
8	501234.60	5442575.76	2.58	0	4000	64.7	64.7	0.0	0.0	71.8	35.9	-1.7	0.0	0.0	0.0	0.0	-0.0	-41.4	-41.4
9	501234.60	5442575.76	2.58	0	8000	55.6	55.6	0.0	0.0	71.8	128.2	-1.7	0.0	0.0	0.0	0.0	-0.0	-142.8	-142.8

Point Source, ISO 9613, Name: "MM_Trans5", ID: "MM_Trans5"																			
Nr.	X	Y	Z	Refl.	Freq.	LxT	LxN	K0	Dc	Adiv	Aatm	Agr	Afol	Ahous	Abar	Cmet	RL	LrT	LrN
	(m)	(m)	(m)		(Hz)	dB(A)	dB(A)	(dB)	(dB)	(dB)	(dB)	(dB)	(dB)	(dB)	(dB)	(dB)	(dB)	dB(A)	dB(A)
1	500983.17	5442553.41	2.58	0	32	37.3	37.3	0.0	0.0	71.9	0.0	-5.7	0.0	0.0	0.0	0.0	-0.0	-28.9	-28.9
2	500983.17	5442553.41	2.58	0	63	56.5	56.5	0.0	0.0	71.9	0.1	-5.7	0.0	0.0	0.0	0.0	-0.0	-9.8	-9.8

Point Source, ISO 9613, Name: "MM_Trans5", ID: "MM_Trans5"																			
Nr.	X	Y	Z	Refl.	Freq.	LxT	LxN	K0	Dc	Adiv	Aatm	Agr	Afol	Ahous	Abar	Cmet	RL	LrT	LrN
	(m)	(m)	(m)		(Hz)	dB(A)	dB(A)	(dB)	(dB)	(dB)	(dB)	(dB)	(dB)	(dB)	(dB)	(dB)	(dB)	dB(A)	dB(A)
3	500983.17	5442553.41	2.58	0	125	68.6	68.6	0.0	0.0	71.9	0.5	5.1	0.0	0.0	0.0	0.0	-0.0	-8.8	-8.8
4	500983.17	5442553.41	2.58	0	250	71.1	71.1	0.0	0.0	71.9	1.2	6.5	0.0	0.0	0.0	0.0	-0.0	-8.4	-8.4
5	500983.17	5442553.41	2.58	0	500	76.5	76.5	0.0	0.0	71.9	2.1	2.2	0.0	0.0	0.0	0.0	-0.0	0.3	0.3
6	500983.17	5442553.41	2.58	0	1000	73.7	73.7	0.0	0.0	71.9	4.0	-1.2	0.0	0.0	0.0	0.0	-0.0	-1.0	-1.0
7	500983.17	5442553.41	2.58	0	2000	69.9	69.9	0.0	0.0	71.9	10.7	-1.7	0.0	0.0	0.0	0.0	-0.0	-10.9	-10.9
8	500983.17	5442553.41	2.58	0	4000	64.7	64.7	0.0	0.0	71.9	36.2	-1.7	0.0	0.0	0.0	0.0	-0.0	-41.7	-41.7
9	500983.17	5442553.41	2.58	0	8000	55.6	55.6	0.0	0.0	71.9	129.1	-1.7	0.0	0.0	0.0	0.0	-0.0	-143.7	-143.7

Point Source, ISO 9613, Name: "MM_Trans6", ID: "MM_Trans6"																			
Nr.	X	Y	Z	Refl.	Freq.	LxT	LxN	K0	Dc	Adiv	Aatm	Agr	Afol	Ahous	Abar	Cmet	RL	LrT	LrN
	(m)	(m)	(m)		(Hz)	dB(A)	dB(A)	(dB)	(dB)	(dB)	(dB)	(dB)	(dB)	(dB)	(dB)	(dB)	(dB)	dB(A)	dB(A)
1	500983.17	5442755.01	2.58	0	32	37.3	37.3	0.0	0.0	70.1	0.0	-5.6	0.0	0.0	0.0	0.0	-0.0	-27.3	-27.3
2	500983.17	5442755.01	2.58	0	63	56.5	56.5	0.0	0.0	70.1	0.1	-5.6	0.0	0.0	0.0	0.0	-0.0	-8.1	-8.1
3	500983.17	5442755.01	2.58	0	125	68.6	68.6	0.0	0.0	70.1	0.4	4.7	0.0	0.0	0.0	0.0	-0.0	-6.6	-6.6
4	500983.17	5442755.01	2.58	0	250	71.1	71.1	0.0	0.0	70.1	0.9	6.5	0.0	0.0	0.0	0.0	-0.0	-6.5	-6.5
5	500983.17	5442755.01	2.58	0	500	76.5	76.5	0.0	0.0	70.1	1.7	2.3	0.0	0.0	0.0	0.0	-0.0	2.4	2.4
6	500983.17	5442755.01	2.58	0	1000	73.7	73.7	0.0	0.0	70.1	3.3	-1.2	0.0	0.0	0.0	0.0	-0.0	1.5	1.5
7	500983.17	5442755.01	2.58	0	2000	69.9	69.9	0.0	0.0	70.1	8.7	-1.7	0.0	0.0	0.0	0.0	-0.0	-7.3	-7.3
8	500983.17	5442755.01	2.58	0	4000	64.7	64.7	0.0	0.0	70.1	29.6	-1.7	0.0	0.0	0.0	0.0	-0.0	-33.3	-33.3
9	500983.17	5442755.01	2.58	0	8000	55.6	55.6	0.0	0.0	70.1	105.6	-1.7	0.0	0.0	0.0	0.0	-0.0	-118.5	-118.5

Point Source, ISO 9613, Name: "MM_Trans7", ID: "MM_Trans7"																			
Nr.	X	Y	Z	Refl.	Freq.	LxT	LxN	K0	Dc	Adiv	Aatm	Agr	Afol	Ahous	Abar	Cmet	RL	LrT	LrN
	(m)	(m)	(m)		(Hz)	dB(A)	dB(A)	(dB)	(dB)	(dB)	(dB)	(dB)	(dB)	(dB)	(dB)	(dB)	(dB)	dB(A)	dB(A)
1	500983.17	5442956.56	2.58	0	32	37.3	37.3	0.0	0.0	67.9	0.0	-5.5	0.0	0.0	0.0	0.0	-0.0	-25.2	-25.2
2	500983.17	5442956.56	2.58	0	63	56.5	56.5	0.0	0.0	67.9	0.1	-5.5	0.0	0.0	0.0	0.0	-0.0	-6.0	-6.0
3	500983.17	5442956.56	2.58	0	125	68.6	68.6	0.0	0.0	67.9	0.3	4.0	0.0	0.0	0.0	0.0	-0.0	-3.6	-3.6
4	500983.17	5442956.56	2.58	0	250	71.1	71.1	0.0	0.0	67.9	0.7	6.6	0.0	0.0	0.0	0.0	-0.0	-4.1	-4.1
5	500983.17	5442956.56	2.58	0	500	76.5	76.5	0.0	0.0	67.9	1.4	2.3	0.0	0.0	0.0	0.0	-0.0	4.9	4.9
6	500983.17	5442956.56	2.58	0	1000	73.7	73.7	0.0	0.0	67.9	2.6	-1.2	0.0	0.0	0.0	0.0	-0.0	4.4	4.4
7	500983.17	5442956.56	2.58	0	2000	69.9	69.9	0.0	0.0	67.9	6.8	-1.6	0.0	0.0	0.0	0.0	-0.0	-3.2	-3.2
8	500983.17	5442956.56	2.58	0	4000	64.7	64.7	0.0	0.0	67.9	23.0	-1.6	0.0	0.0	0.0	0.0	-0.0	-24.6	-24.6
9	500983.17	5442956.56	2.58	0	8000	55.6	55.6	0.0	0.0	67.9	82.1	-1.6	0.0	0.0	0.0	0.0	-0.0	-92.8	-92.8

Receiver

Name: 15_R42
 ID: 15_R42
 X: 501814.37
 Y: 5443560.06
 Z: 1.50

Point Source, ISO 9613, Name: "Ab_Sub115", ID: "Ab_Sub115"																			
Nr.	X (m)	Y (m)	Z (m)	Refl.	Freq. (Hz)	LxT dB(A)	LxN dB(A)	K0 (dB)	Dc (dB)	Adiv (dB)	Aatm (dB)	Agr (dB)	Afol (dB)	Ahouus (dB)	Abar (dB)	Cmet (dB)	RL (dB)	LrT dB(A)	LrN dB(A)
1	501008.63	5443536.29	3.60	0	32	43.3	43.3	0.0	0.0	69.1	0.0	-5.4	0.0	0.0	0.0	0.0	-0.0	-20.4	-20.4
2	501008.63	5443536.29	3.60	0	63	60.5	60.5	0.0	0.0	69.1	0.1	-5.4	0.0	0.0	0.0	0.0	-0.0	-3.3	-3.3
3	501008.63	5443536.29	3.60	0	125	73.6	73.6	0.0	0.0	69.1	0.3	4.3	0.0	0.0	0.0	0.0	-0.0	-0.1	-0.1
4	501008.63	5443536.29	3.60	0	250	79.1	79.1	0.0	0.0	69.1	0.8	5.2	0.0	0.0	0.0	0.0	-0.0	4.0	4.0
5	501008.63	5443536.29	3.60	0	500	84.5	84.5	0.0	0.0	69.1	1.6	1.9	0.0	0.0	0.0	0.0	-0.0	11.9	11.9
6	501008.63	5443536.29	3.60	0	1000	81.7	81.7	0.0	0.0	69.1	2.9	-1.2	0.0	0.0	0.0	0.0	-0.0	10.8	10.8
7	501008.63	5443536.29	3.60	0	2000	77.9	77.9	0.0	0.0	69.1	7.8	-1.6	0.0	0.0	0.0	0.0	-0.0	2.6	2.6
8	501008.63	5443536.29	3.60	0	4000	72.7	72.7	0.0	0.0	69.1	26.4	-1.6	0.0	0.0	0.0	0.0	-0.0	-21.2	-21.2
9	501008.63	5443536.29	3.60	0	8000	62.6	62.6	0.0	0.0	69.1	94.2	-1.6	0.0	0.0	0.0	0.0	-0.0	-99.1	-99.1

Point Source, ISO 9613, Name: "Ab_Inv1", ID: "Ab_Inv1"																			
Nr.	X (m)	Y (m)	Z (m)	Refl.	Freq. (Hz)	LxT dB(A)	LxN dB(A)	K0 (dB)	Dc (dB)	Adiv (dB)	Aatm (dB)	Agr (dB)	Afol (dB)	Ahouus (dB)	Abar (dB)	Cmet (dB)	RL (dB)	LrT dB(A)	LrN dB(A)
1	501813.68	5442663.24	2.60	0	63	68.1	68.1	0.0	0.0	70.0	0.1	-5.6	0.0	0.0	0.0	0.0	-0.0	3.5	3.5
2	501813.68	5442663.24	2.60	0	125	78.9	78.9	0.0	0.0	70.0	0.4	4.7	0.0	0.0	0.0	0.0	-0.0	3.8	3.8
3	501813.68	5442663.24	2.60	0	250	85.5	85.5	0.0	0.0	70.0	0.9	6.5	0.0	0.0	0.0	0.0	-0.0	8.0	8.0
4	501813.68	5442663.24	2.60	0	500	87.3	87.3	0.0	0.0	70.0	1.7	2.2	0.0	0.0	0.0	0.0	-0.0	13.3	13.3
5	501813.68	5442663.24	2.60	0	1000	83.7	83.7	0.0	0.0	70.0	3.3	-1.2	0.0	0.0	0.0	0.0	-0.0	11.6	11.6
6	501813.68	5442663.24	2.60	0	2000	79.1	79.1	0.0	0.0	70.0	8.7	-1.7	0.0	0.0	0.0	0.0	-0.0	2.1	2.1
7	501813.68	5442663.24	2.60	0	4000	70.0	70.0	0.0	0.0	70.0	29.4	-1.7	0.0	0.0	0.0	0.0	-0.0	-27.8	-27.8
8	501813.68	5442663.24	2.60	0	8000	77.7	77.7	0.0	0.0	70.0	104.8	-1.7	0.0	0.0	0.0	0.0	-0.0	-95.5	-95.5

Point Source, ISO 9613, Name: "Ab_Inv2", ID: "Ab_Inv2"																			
Nr.	X (m)	Y (m)	Z (m)	Refl.	Freq. (Hz)	LxT dB(A)	LxN dB(A)	K0 (dB)	Dc (dB)	Adiv (dB)	Aatm (dB)	Agr (dB)	Afol (dB)	Ahouus (dB)	Abar (dB)	Cmet (dB)	RL (dB)	LrT dB(A)	LrN dB(A)
1	501813.68	5442842.44	2.60	0	63	68.1	68.1	0.0	0.0	68.1	0.1	-5.5	0.0	0.0	0.0	0.0	-0.0	5.4	5.4
2	501813.68	5442842.44	2.60	0	125	78.9	78.9	0.0	0.0	68.1	0.3	4.0	0.0	0.0	0.0	0.0	-0.0	6.5	6.5
3	501813.68	5442842.44	2.60	0	250	85.5	85.5	0.0	0.0	68.1	0.8	6.5	0.0	0.0	0.0	0.0	-0.0	10.1	10.1
4	501813.68	5442842.44	2.60	0	500	87.3	87.3	0.0	0.0	68.1	1.4	2.3	0.0	0.0	0.0	0.0	-0.0	15.5	15.5
5	501813.68	5442842.44	2.60	0	1000	83.7	83.7	0.0	0.0	68.1	2.6	-1.2	0.0	0.0	0.0	0.0	-0.0	14.1	14.1
6	501813.68	5442842.44	2.60	0	2000	79.1	79.1	0.0	0.0	68.1	6.9	-1.7	0.0	0.0	0.0	0.0	-0.0	5.7	5.7
7	501813.68	5442842.44	2.60	0	4000	70.0	70.0	0.0	0.0	68.1	23.5	-1.7	0.0	0.0	0.0	0.0	-0.0	-20.0	-20.0
8	501813.68	5442842.44	2.60	0	8000	77.7	77.7	0.0	0.0	68.1	83.9	-1.7	0.0	0.0	0.0	0.0	-0.0	-72.6	-72.6

Point Source, ISO 9613, Name: "Ab_Inv3", ID: "Ab_Inv3"																			
Nr.	X (m)	Y (m)	Z (m)	Refl.	Freq. (Hz)	LxT dB(A)	LxN dB(A)	K0 (dB)	Dc (dB)	Adiv (dB)	Aatm (dB)	Agr (dB)	Afol (dB)	Ahouus (dB)	Abar (dB)	Cmet (dB)	RL (dB)	LrT dB(A)	LrN dB(A)
1	501813.58	5443021.64	2.60	0	63	68.1	68.1	0.0	0.0	65.6	0.1	-5.3	0.0	0.0	0.0	0.0	-0.0	7.7	7.7
2	501813.58	5443021.64	2.60	0	125	78.9	78.9	0.0	0.0	65.6	0.2	3.0	0.0	0.0	0.0	0.0	-0.0	10.1	10.1
3	501813.58	5443021.64	2.60	0	250	85.5	85.5	0.0	0.0	65.6	0.6	6.6	0.0	0.0	0.0	0.0	-0.0	12.7	12.7
4	501813.58	5443021.64	2.60	0	500	87.3	87.3	0.0	0.0	65.6	1.0	2.3	0.0	0.0	0.0	0.0	-0.0	18.3	18.3
5	501813.58	5443021.64	2.60	0	1000	83.7	83.7	0.0	0.0	65.6	2.0	-1.1	0.0	0.0	0.0	0.0	-0.0	17.2	17.2
6	501813.58	5443021.64	2.60	0	2000	79.1	79.1	0.0	0.0	65.6	5.2	-1.6	0.0	0.0	0.0	0.0	-0.0	9.9	9.9
7	501813.58	5443021.64	2.60	0	4000	70.0	70.0	0.0	0.0	65.6	17.6	-1.6	0.0	0.0	0.0	0.0	-0.0	-11.7	-11.7
8	501813.58	5443021.64	2.60	0	8000	77.7	77.7	0.0	0.0	65.6	62.9	-1.6	0.0	0.0	0.0	0.0	-0.0	-49.3	-49.3

Point Source, ISO 9613, Name: "Ab_Inv4", ID: "Ab_Inv4"																			
Nr.	X (m)	Y (m)	Z (m)	Refl.	Freq. (Hz)	LxT dB(A)	LxN dB(A)	K0 (dB)	Dc (dB)	Adiv (dB)	Aatm (dB)	Agr (dB)	Afol (dB)	Ahouus (dB)	Abar (dB)	Cmet (dB)	RL (dB)	LrT dB(A)	LrN dB(A)
1	501813.68	5443200.84	2.60	0	63	68.1	68.1	0.0	0.0	62.1	0.0	-5.0	0.0	0.0	0.0	0.0	-0.0	10.9	10.9
2	501813.68	5443200.84	2.60	0	125	78.9	78.9	0.0	0.0	62.1	0.2	1.7	0.0	0.0	0.0	0.0	-0.0	15.0	15.0
3	501813.68	5443200.84	2.60	0	250	85.5	85.5	0.0	0.0	62.1	0.4	6.7	0.0	0.0	0.0	0.0	-0.0	16.3	16.3
4	501813.68	5443200.84	2.60	0	500	87.3	87.3	0.0	0.0	62.1	0.7	2.4	0.0	0.0	0.0	0.0	-0.0	22.1	22.1

Point Source, ISO 9613, Name: "Ab_Inv4", ID: "Ab_Inv4"																			
Nr.	X	Y	Z	Refl.	Freq.	LxT	LxN	K0	Dc	Adiv	Aatm	Agr	Afol	Ahous	Abar	Cmet	RL	LrT	LrN
	(m)	(m)	(m)		(Hz)	dB(A)	dB(A)	(dB)	(dB)	(dB)	(dB)	(dB)	(dB)	(dB)	(dB)	(dB)	(dB)	dB(A)	dB(A)
5	501813.68	5443200.84	2.60	0	1000	83.7	83.7	0.0	0.0	62.1	1.3	-1.0	0.0	0.0	0.0	0.0	-0.0	21.3	21.3
6	501813.68	5443200.84	2.60	0	2000	79.1	79.1	0.0	0.0	62.1	3.5	-1.5	0.0	0.0	0.0	0.0	-0.0	15.0	15.0
7	501813.68	5443200.84	2.60	0	4000	70.0	70.0	0.0	0.0	62.1	11.8	-1.5	0.0	0.0	0.0	0.0	-0.0	-2.4	-2.4
8	501813.68	5443200.84	2.60	0	8000	77.7	77.7	0.0	0.0	62.1	42.0	-1.5	0.0	0.0	0.0	0.0	-0.0	-24.9	-24.9

Point Source, ISO 9613, Name: "Ab_Inv5", ID: "Ab_Inv5"																			
Nr.	X	Y	Z	Refl.	Freq.	LxT	LxN	K0	Dc	Adiv	Aatm	Agr	Afol	Ahous	Abar	Cmet	RL	LrT	LrN
	(m)	(m)	(m)		(Hz)	dB(A)	dB(A)	(dB)	(dB)	(dB)	(dB)	(dB)	(dB)	(dB)	(dB)	(dB)	(dB)	dB(A)	dB(A)
1	502235.01	5442875.04	2.60	0	63	68.1	68.1	0.0	0.0	69.1	0.1	-5.5	0.0	0.0	0.0	0.0	-0.0	4.4	4.4
2	502235.01	5442875.04	2.60	0	125	78.9	78.9	0.0	0.0	69.1	0.3	4.4	0.0	0.0	0.0	0.0	-0.0	5.0	5.0
3	502235.01	5442875.04	2.60	0	250	85.5	85.5	0.0	0.0	69.1	0.8	6.5	0.0	0.0	0.0	0.0	-0.0	9.0	9.0
4	502235.01	5442875.04	2.60	0	500	87.3	87.3	0.0	0.0	69.1	1.6	2.3	0.0	0.0	0.0	0.0	-0.0	14.4	14.4
5	502235.01	5442875.04	2.60	0	1000	83.7	83.7	0.0	0.0	69.1	2.9	-1.2	0.0	0.0	0.0	0.0	-0.0	12.9	12.9
6	502235.01	5442875.04	2.60	0	2000	79.1	79.1	0.0	0.0	69.1	7.8	-1.7	0.0	0.0	0.0	0.0	-0.0	3.9	3.9
7	502235.01	5442875.04	2.60	0	4000	70.0	70.0	0.0	0.0	69.1	26.3	-1.7	0.0	0.0	0.0	0.0	-0.0	-23.8	-23.8
8	502235.01	5442875.04	2.60	0	8000	77.7	77.7	0.0	0.0	69.1	94.0	-1.7	0.0	0.0	0.0	0.0	-0.0	-83.7	-83.7

Point Source, ISO 9613, Name: "Ab_Inv6", ID: "Ab_Inv6"																			
Nr.	X	Y	Z	Refl.	Freq.	LxT	LxN	K0	Dc	Adiv	Aatm	Agr	Afol	Ahous	Abar	Cmet	RL	LrT	LrN
	(m)	(m)	(m)		(Hz)	dB(A)	dB(A)	(dB)	(dB)	(dB)	(dB)	(dB)	(dB)	(dB)	(dB)	(dB)	(dB)	dB(A)	dB(A)
1	502235.01	5443065.44	2.60	0	63	68.1	68.1	0.0	0.0	67.3	0.1	-5.4	0.0	0.0	0.0	0.0	-0.0	6.2	6.2
2	502235.01	5443065.44	2.60	0	125	78.9	78.9	0.0	0.0	67.3	0.3	3.7	0.0	0.0	0.0	0.0	-0.0	7.7	7.7
3	502235.01	5443065.44	2.60	0	250	85.5	85.5	0.0	0.0	67.3	0.7	6.6	0.0	0.0	0.0	0.0	-0.0	11.0	11.0
4	502235.01	5443065.44	2.60	0	500	87.3	87.3	0.0	0.0	67.3	1.3	2.3	0.0	0.0	0.0	0.0	-0.0	16.5	16.5
5	502235.01	5443065.44	2.60	0	1000	83.7	83.7	0.0	0.0	67.3	2.4	-1.2	0.0	0.0	0.0	0.0	-0.0	15.2	15.2
6	502235.01	5443065.44	2.60	0	2000	79.1	79.1	0.0	0.0	67.3	6.3	-1.6	0.0	0.0	0.0	0.0	-0.0	7.2	7.2
7	502235.01	5443065.44	2.60	0	4000	70.0	70.0	0.0	0.0	67.3	21.3	-1.6	0.0	0.0	0.0	0.0	-0.0	-16.9	-16.9
8	502235.01	5443065.44	2.60	0	8000	77.7	77.7	0.0	0.0	67.3	75.9	-1.6	0.0	0.0	0.0	0.0	-0.0	-63.8	-63.8

Point Source, ISO 9613, Name: "Ab_Inv7", ID: "Ab_Inv7"																			
Nr.	X	Y	Z	Refl.	Freq.	LxT	LxN	K0	Dc	Adiv	Aatm	Agr	Afol	Ahous	Abar	Cmet	RL	LrT	LrN
	(m)	(m)	(m)		(Hz)	dB(A)	dB(A)	(dB)	(dB)	(dB)	(dB)	(dB)	(dB)	(dB)	(dB)	(dB)	(dB)	dB(A)	dB(A)
1	502235.01	5443257.84	2.60	0	63	68.1	68.1	0.0	0.0	65.3	0.1	-5.3	0.0	0.0	0.0	0.0	-0.0	8.0	8.0
2	502235.01	5443257.84	2.60	0	125	78.9	78.9	0.0	0.0	65.3	0.2	2.8	0.0	0.0	0.0	0.0	-0.0	10.6	10.6
3	502235.01	5443257.84	2.60	0	250	85.5	85.5	0.0	0.0	65.3	0.5	6.6	0.0	0.0	0.0	0.0	-0.0	13.1	13.1
4	502235.01	5443257.84	2.60	0	500	87.3	87.3	0.0	0.0	65.3	1.0	2.3	0.0	0.0	0.0	0.0	-0.0	18.7	18.7
5	502235.01	5443257.84	2.60	0	1000	83.7	83.7	0.0	0.0	65.3	1.9	-1.1	0.0	0.0	0.0	0.0	-0.0	17.6	17.6
6	502235.01	5443257.84	2.60	0	2000	79.1	79.1	0.0	0.0	65.3	5.0	-1.6	0.0	0.0	0.0	0.0	-0.0	10.4	10.4
7	502235.01	5443257.84	2.60	0	4000	70.0	70.0	0.0	0.0	65.3	17.0	-1.6	0.0	0.0	0.0	0.0	-0.0	-10.7	-10.7
8	502235.01	5443257.84	2.60	0	8000	77.7	77.7	0.0	0.0	65.3	60.5	-1.6	0.0	0.0	0.0	0.0	-0.0	-46.5	-46.5

Point Source, ISO 9613, Name: "Ab_Trans1", ID: "Ab_Trans1"																			
Nr.	X	Y	Z	Refl.	Freq.	LxT	LxN	K0	Dc	Adiv	Aatm	Agr	Afol	Ahous	Abar	Cmet	RL	LrT	LrN
	(m)	(m)	(m)		(Hz)	dB(A)	dB(A)	(dB)	(dB)	(dB)	(dB)	(dB)	(dB)	(dB)	(dB)	(dB)	(dB)	dB(A)	dB(A)
1	501819.18	5442662.74	2.58	0	32	37.3	37.3	0.0	0.0	70.1	0.0	-5.6	0.0	0.0	0.0	0.0	-0.0	-27.2	-27.2
2	501819.18	5442662.74	2.58	0	63	56.5	56.5	0.0	0.0	70.1	0.1	-5.6	0.0	0.0	0.0	0.0	-0.0	-8.1	-8.1
3	501819.18	5442662.74	2.58	0	125	68.6	68.6	0.0	0.0	70.1	0.4	4.7	0.0	0.0	0.0	0.0	-0.0	-6.5	-6.5
4	501819.18	5442662.74	2.58	0	250	71.1	71.1	0.0	0.0	70.1	0.9	6.5	0.0	0.0	0.0	0.0	-0.0	-6.4	-6.4
5	501819.18	5442662.74	2.58	0	500	76.5	76.5	0.0	0.0	70.1	1.7	2.3	0.0	0.0	0.0	0.0	-0.0	2.4	2.4
6	501819.18	5442662.74	2.58	0	1000	73.7	73.7	0.0	0.0	70.1	3.3	-1.2	0.0	0.0	0.0	0.0	-0.0	1.6	1.6
7	501819.18	5442662.74	2.58	0	2000	69.9	69.9	0.0	0.0	70.1	8.7	-1.7	0.0	0.0	0.0	0.0	-0.0	-7.1	-7.1
8	501819.18	5442662.74	2.58	0	4000	64.7	64.7	0.0	0.0	70.1	29.4	-1.7	0.0	0.0	0.0	0.0	-0.0	-33.1	-33.1
9	501819.18	5442662.74	2.58	0	8000	55.6	55.6	0.0	0.0	70.1	104.9	-1.7	0.0	0.0	0.0	0.0	-0.0	-117.7	-117.7

Point Source, ISO 9613, Name: "Ab_Trans2", ID: "Ab_Trans2"																			
Nr.	X	Y	Z	Refl.	Freq.	LxT	LxN	K0	Dc	Adiv	Aatm	Agr	Afol	Ahous	Abar	Cmet	RL	LrT	LrN
	(m)	(m)	(m)		(Hz)	dB(A)	dB(A)	(dB)	(dB)	(dB)	(dB)	(dB)	(dB)	(dB)	(dB)	(dB)	(dB)	dB(A)	dB(A)
1	501819.18	5442841.94	2.58	0	32	37.3	37.3	0.0	0.0	68.1	0.0	-5.5	0.0	0.0	0.0	0.0	-0.0	-25.4	-25.4
2	501819.18	5442841.94	2.58	0	63	56.5	56.5	0.0	0.0	68.1	0.1	-5.5	0.0	0.0	0.0	0.0	-0.0	-6.2	-6.2
3	501819.18	5442841.94	2.58	0	125	68.6	68.6	0.0	0.0	68.1	0.3	4.0	0.0	0.0	0.0	0.0	-0.0	-3.9	-3.9
4	501819.18	5442841.94	2.58	0	250	71.1	71.1	0.0	0.0	68.1	0.8	6.6	0.0	0.0	0.0	0.0	-0.0	-4.3	-4.3
5	501819.18	5442841.94	2.58	0	500	76.5	76.5	0.0	0.0	68.1	1.4	2.3	0.0	0.0	0.0	0.0	-0.0	4.7	4.7
6	501819.18	5442841.94	2.58	0	1000	73.7	73.7	0.0	0.0	68.1	2.6	-1.2	0.0	0.0	0.0	0.0	-0.0	4.1	4.1

Point Source, ISO 9613, Name: "Ab_Trans2", ID: "Ab_Trans2"																			
Nr.	X	Y	Z	Refl.	Freq.	LxT	LxN	K0	Dc	Adiv	Aatm	Agr	Afol	Ahaus	Abar	Cmet	RL	LrT	LrN
	(m)	(m)	(m)		(Hz)	dB(A)	dB(A)	(dB)	(dB)	(dB)	(dB)	(dB)	(dB)	(dB)	(dB)	(dB)	(dB)	dB(A)	dB(A)
7	501819.18	5442841.94	2.58	0	2000	69.9	69.9	0.0	0.0	68.1	6.9	-1.7	0.0	0.0	0.0	0.0	-0.0	-3.5	-3.5
8	501819.18	5442841.94	2.58	0	4000	64.7	64.7	0.0	0.0	68.1	23.5	-1.7	0.0	0.0	0.0	0.0	-0.0	-25.3	-25.3
9	501819.18	5442841.94	2.58	0	8000	55.6	55.6	0.0	0.0	68.1	83.9	-1.7	0.0	0.0	0.0	0.0	-0.0	-94.8	-94.8

Point Source, ISO 9613, Name: "Ab_Trans3", ID: "Ab_Trans3"																			
Nr.	X	Y	Z	Refl.	Freq.	LxT	LxN	K0	Dc	Adiv	Aatm	Agr	Afol	Ahaus	Abar	Cmet	RL	LrT	LrN
	(m)	(m)	(m)		(Hz)	dB(A)	dB(A)	(dB)	(dB)	(dB)	(dB)	(dB)	(dB)	(dB)	(dB)	(dB)	(dB)	dB(A)	dB(A)
1	501819.08	5443021.14	2.58	0	32	37.3	37.3	0.0	0.0	65.6	0.0	-5.3	0.0	0.0	0.0	0.0	-0.0	-23.0	-23.0
2	501819.08	5443021.14	2.58	0	63	56.5	56.5	0.0	0.0	65.6	0.1	-5.3	0.0	0.0	0.0	0.0	-0.0	-3.9	-3.9
3	501819.08	5443021.14	2.58	0	125	68.6	68.6	0.0	0.0	65.6	0.2	3.0	0.0	0.0	0.0	0.0	-0.0	-0.2	-0.2
4	501819.08	5443021.14	2.58	0	250	71.1	71.1	0.0	0.0	65.6	0.6	6.6	0.0	0.0	0.0	0.0	-0.0	-1.7	-1.7
5	501819.08	5443021.14	2.58	0	500	76.5	76.5	0.0	0.0	65.6	1.0	2.3	0.0	0.0	0.0	0.0	-0.0	7.5	7.5
6	501819.08	5443021.14	2.58	0	1000	73.7	73.7	0.0	0.0	65.6	2.0	-1.1	0.0	0.0	0.0	0.0	-0.0	7.2	7.2
7	501819.08	5443021.14	2.58	0	2000	69.9	69.9	0.0	0.0	65.6	5.2	-1.6	0.0	0.0	0.0	0.0	-0.0	0.7	0.7
8	501819.08	5443021.14	2.58	0	4000	64.7	64.7	0.0	0.0	65.6	17.7	-1.6	0.0	0.0	0.0	0.0	-0.0	-17.0	-17.0
9	501819.08	5443021.14	2.58	0	8000	55.6	55.6	0.0	0.0	65.6	63.0	-1.6	0.0	0.0	0.0	0.0	-0.0	-71.4	-71.4

Point Source, ISO 9613, Name: "Ab_Trans4", ID: "Ab_Trans4"																			
Nr.	X	Y	Z	Refl.	Freq.	LxT	LxN	K0	Dc	Adiv	Aatm	Agr	Afol	Ahaus	Abar	Cmet	RL	LrT	LrN
	(m)	(m)	(m)		(Hz)	dB(A)	dB(A)	(dB)	(dB)	(dB)	(dB)	(dB)	(dB)	(dB)	(dB)	(dB)	(dB)	dB(A)	dB(A)
1	501819.18	5443200.34	2.58	0	32	37.3	37.3	0.0	0.0	62.1	0.0	-5.0	0.0	0.0	0.0	0.0	-0.0	-19.9	-19.9
2	501819.18	5443200.34	2.58	0	63	56.5	56.5	0.0	0.0	62.1	0.0	-5.0	0.0	0.0	0.0	0.0	-0.0	-0.7	-0.7
3	501819.18	5443200.34	2.58	0	125	68.6	68.6	0.0	0.0	62.1	0.2	1.7	0.0	0.0	0.0	0.0	-0.0	4.6	4.6
4	501819.18	5443200.34	2.58	0	250	71.1	71.1	0.0	0.0	62.1	0.4	6.7	0.0	0.0	0.0	0.0	-0.0	1.9	1.9
5	501819.18	5443200.34	2.58	0	500	76.5	76.5	0.0	0.0	62.1	0.7	2.4	0.0	0.0	0.0	0.0	-0.0	11.2	11.2
6	501819.18	5443200.34	2.58	0	1000	73.7	73.7	0.0	0.0	62.1	1.3	-1.0	0.0	0.0	0.0	0.0	-0.0	11.3	11.3
7	501819.18	5443200.34	2.58	0	2000	69.9	69.9	0.0	0.0	62.1	3.5	-1.5	0.0	0.0	0.0	0.0	-0.0	5.8	5.8
8	501819.18	5443200.34	2.58	0	4000	64.7	64.7	0.0	0.0	62.1	11.8	-1.5	0.0	0.0	0.0	0.0	-0.0	-7.7	-7.7
9	501819.18	5443200.34	2.58	0	8000	55.6	55.6	0.0	0.0	62.1	42.0	-1.5	0.0	0.0	0.0	0.0	-0.0	-47.1	-47.1

Point Source, ISO 9613, Name: "Ab_Trans5", ID: "Ab_Trans5"																			
Nr.	X	Y	Z	Refl.	Freq.	LxT	LxN	K0	Dc	Adiv	Aatm	Agr	Afol	Ahaus	Abar	Cmet	RL	LrT	LrN
	(m)	(m)	(m)		(Hz)	dB(A)	dB(A)	(dB)	(dB)	(dB)	(dB)	(dB)	(dB)	(dB)	(dB)	(dB)	(dB)	dB(A)	dB(A)
1	502229.51	5442875.54	2.58	0	32	37.3	37.3	0.0	0.0	69.1	0.0	-5.5	0.0	0.0	0.0	0.0	-0.0	-26.3	-26.3
2	502229.51	5442875.54	2.58	0	63	56.5	56.5	0.0	0.0	69.1	0.1	-5.5	0.0	0.0	0.0	0.0	-0.0	-7.1	-7.1
3	502229.51	5442875.54	2.58	0	125	68.6	68.6	0.0	0.0	69.1	0.3	4.4	0.0	0.0	0.0	0.0	-0.0	-5.2	-5.2
4	502229.51	5442875.54	2.58	0	250	71.1	71.1	0.0	0.0	69.1	0.8	6.6	0.0	0.0	0.0	0.0	-0.0	-5.4	-5.4
5	502229.51	5442875.54	2.58	0	500	76.5	76.5	0.0	0.0	69.1	1.5	2.3	0.0	0.0	0.0	0.0	-0.0	3.6	3.6
6	502229.51	5442875.54	2.58	0	1000	73.7	73.7	0.0	0.0	69.1	2.9	-1.2	0.0	0.0	0.0	0.0	-0.0	2.9	2.9
7	502229.51	5442875.54	2.58	0	2000	69.9	69.9	0.0	0.0	69.1	7.7	-1.7	0.0	0.0	0.0	0.0	-0.0	-5.2	-5.2
8	502229.51	5442875.54	2.58	0	4000	64.7	64.7	0.0	0.0	69.1	26.2	-1.7	0.0	0.0	0.0	0.0	-0.0	-28.9	-28.9
9	502229.51	5442875.54	2.58	0	8000	55.6	55.6	0.0	0.0	69.1	93.6	-1.7	0.0	0.0	0.0	0.0	-0.0	-105.4	-105.4

Point Source, ISO 9613, Name: "Ab_Trans6", ID: "Ab_Trans6"																			
Nr.	X	Y	Z	Refl.	Freq.	LxT	LxN	K0	Dc	Adiv	Aatm	Agr	Afol	Ahaus	Abar	Cmet	RL	LrT	LrN
	(m)	(m)	(m)		(Hz)	dB(A)	dB(A)	(dB)	(dB)	(dB)	(dB)	(dB)	(dB)	(dB)	(dB)	(dB)	(dB)	dB(A)	dB(A)
1	502229.51	5443065.94	2.58	0	32	37.3	37.3	0.0	0.0	67.2	0.0	-5.4	0.0	0.0	0.0	0.0	-0.0	-24.5	-24.5
2	502229.51	5443065.94	2.58	0	63	56.5	56.5	0.0	0.0	67.2	0.1	-5.4	0.0	0.0	0.0	0.0	-0.0	-5.3	-5.3
3	502229.51	5443065.94	2.58	0	125	68.6	68.6	0.0	0.0	67.2	0.3	3.6	0.0	0.0	0.0	0.0	-0.0	-2.5	-2.5
4	502229.51	5443065.94	2.58	0	250	71.1	71.1	0.0	0.0	67.2	0.7	6.6	0.0	0.0	0.0	0.0	-0.0	-3.4	-3.4
5	502229.51	5443065.94	2.58	0	500	76.5	76.5	0.0	0.0	67.2	1.2	2.3	0.0	0.0	0.0	0.0	-0.0	5.8	5.8
6	502229.51	5443065.94	2.58	0	1000	73.7	73.7	0.0	0.0	67.2	2.4	-1.2	0.0	0.0	0.0	0.0	-0.0	5.3	5.3
7	502229.51	5443065.94	2.58	0	2000	69.9	69.9	0.0	0.0	67.2	6.2	-1.6	0.0	0.0	0.0	0.0	-0.0	-1.9	-1.9
8	502229.51	5443065.94	2.58	0	4000	64.7	64.7	0.0	0.0	67.2	21.2	-1.6	0.0	0.0	0.0	0.0	-0.0	-22.0	-22.0
9	502229.51	5443065.94	2.58	0	8000	55.6	55.6	0.0	0.0	67.2	75.4	-1.6	0.0	0.0	0.0	0.0	-0.0	-85.4	-85.4

Point Source, ISO 9613, Name: "Ab_Trans7", ID: "Ab_Trans7"																			
Nr.	X	Y	Z	Refl.	Freq.	LxT	LxN	K0	Dc	Adiv	Aatm	Agr	Afol	Ahaus	Abar	Cmet	RL	LrT	LrN
	(m)	(m)	(m)		(Hz)	dB(A)	dB(A)	(dB)	(dB)	(dB)	(dB)	(dB)	(dB)	(dB)	(dB)	(dB)	(dB)	dB(A)	dB(A)
1	502229.51	5443258.34	2.58	0	32	37.3	37.3	0.0	0.0	65.2	0.0	-5.3	0.0	0.0	0.0	0.0	-0.0	-22.6	-22.6
2	502229.51	5443258.34	2.58	0	63	56.5	56.5	0.0	0.0	65.2	0.1	-5.3	0.0	0.0	0.0	0.0	-0.0	-3.5	-3.5
3	502229.51	5443258.34	2.58	0	125	68.6	68.6	0.0	0.0	65.2	0.2	2.8	0.0	0.0	0.0	0.0	-0.0	0.4	0.4
4	502229.51	5443258.34	2.58	0	250	71.1	71.1	0.0	0.0	65.2	0.5	6.6	0.0	0.0	0.0	0.0	-0.0	-1.3	-1.3

Point Source, ISO 9613, Name: "Ab_Trans7", ID: "Ab_Trans7"																			
Nr.	X	Y	Z	Refl.	Freq.	LxT	LxN	K0	Dc	Adiv	Aatm	Agr	Afol	Ahous	Abar	Cmet	RL	LrT	LrN
	(m)	(m)	(m)		(Hz)	dB(A)	dB(A)	(dB)	(dB)	(dB)	(dB)	(dB)	(dB)	(dB)	(dB)	(dB)	(dB)	dB(A)	dB(A)
5	502229.51	5443258.34	2.58	0	500	76.5	76.5	0.0	0.0	65.2	1.0	2.3	0.0	0.0	0.0	0.0	-0.0	8.0	8.0
6	502229.51	5443258.34	2.58	0	1000	73.7	73.7	0.0	0.0	65.2	1.9	-1.1	0.0	0.0	0.0	0.0	-0.0	7.7	7.7
7	502229.51	5443258.34	2.58	0	2000	69.9	69.9	0.0	0.0	65.2	5.0	-1.6	0.0	0.0	0.0	0.0	-0.0	1.3	1.3
8	502229.51	5443258.34	2.58	0	4000	64.7	64.7	0.0	0.0	65.2	16.8	-1.6	0.0	0.0	0.0	0.0	-0.0	-15.7	-15.7
9	502229.51	5443258.34	2.58	0	8000	55.6	55.6	0.0	0.0	65.2	60.0	-1.6	0.0	0.0	0.0	0.0	-0.0	-68.0	-68.0

Point Source, ISO 9613, Name: "Em_Sub115", ID: "Em_Sub115"																			
Nr.	X	Y	Z	Refl.	Freq.	LxT	LxN	K0	Dc	Adiv	Aatm	Agr	Afol	Ahous	Abar	Cmet	RL	LrT	LrN
	(m)	(m)	(m)		(Hz)	dB(A)	dB(A)	(dB)	(dB)	(dB)	(dB)	(dB)	(dB)	(dB)	(dB)	(dB)	(dB)	dB(A)	dB(A)
1	500978.58	5443536.29	3.60	0	32	43.3	43.3	0.0	0.0	69.5	0.0	-5.5	0.0	0.0	0.0	0.0	-0.0	-20.7	-20.7
2	500978.58	5443536.29	3.60	0	63	60.5	60.5	0.0	0.0	69.5	0.1	-5.5	0.0	0.0	0.0	0.0	-0.0	-3.6	-3.6
3	500978.58	5443536.29	3.60	0	125	73.6	73.6	0.0	0.0	69.5	0.3	4.4	0.0	0.0	0.0	0.0	-0.0	-0.6	-0.6
4	500978.58	5443536.29	3.60	0	250	79.1	79.1	0.0	0.0	69.5	0.9	5.2	0.0	0.0	0.0	0.0	-0.0	3.6	3.6
5	500978.58	5443536.29	3.60	0	500	84.5	84.5	0.0	0.0	69.5	1.6	1.9	0.0	0.0	0.0	0.0	-0.0	11.6	11.6
6	500978.58	5443536.29	3.60	0	1000	81.7	81.7	0.0	0.0	69.5	3.1	-1.2	0.0	0.0	0.0	0.0	-0.0	10.4	10.4
7	500978.58	5443536.29	3.60	0	2000	77.9	77.9	0.0	0.0	69.5	8.1	-1.6	0.0	0.0	0.0	0.0	-0.0	2.0	2.0
8	500978.58	5443536.29	3.60	0	4000	72.7	72.7	0.0	0.0	69.5	27.4	-1.6	0.0	0.0	0.0	0.0	-0.0	-22.5	-22.5
9	500978.58	5443536.29	3.60	0	8000	62.6	62.6	0.0	0.0	69.5	97.7	-1.6	0.0	0.0	0.0	0.0	-0.0	-102.9	-102.9

Point Source, ISO 9613, Name: "Em_Inv1", ID: "Em_Inv1"																			
Nr.	X	Y	Z	Refl.	Freq.	LxT	LxN	K0	Dc	Adiv	Aatm	Agr	Afol	Ahous	Abar	Cmet	RL	LrT	LrN
	(m)	(m)	(m)		(Hz)	dB(A)	dB(A)	(dB)	(dB)	(dB)	(dB)	(dB)	(dB)	(dB)	(dB)	(dB)	(dB)	dB(A)	dB(A)
1	500760.53	5441418.41	2.60	0	63	68.1	68.1	0.0	0.0	78.6	0.3	-5.8	0.0	0.0	0.0	0.0	-0.0	-4.9	-4.9
2	500760.53	5441418.41	2.60	0	125	78.9	78.9	0.0	0.0	78.6	1.0	5.2	0.0	0.0	0.0	0.0	-0.0	-5.8	-5.8
3	500760.53	5441418.41	2.60	0	250	85.5	85.5	0.0	0.0	78.6	2.5	6.4	0.0	0.0	0.0	0.0	-0.0	-2.0	-2.0
4	500760.53	5441418.41	2.60	0	500	87.3	87.3	0.0	0.0	78.6	4.6	2.2	0.0	0.0	0.0	0.0	-0.0	2.0	2.0
5	500760.53	5441418.41	2.60	0	1000	83.7	83.7	0.0	0.0	78.6	8.7	-1.3	0.0	0.0	0.0	0.0	-0.0	-2.3	-2.3
6	500760.53	5441418.41	2.60	0	2000	79.1	79.1	0.0	0.0	78.6	23.1	-1.8	0.0	0.0	0.0	0.0	-0.0	-20.8	-20.8
7	500760.53	5441418.41	2.60	0	4000	70.0	70.0	0.0	0.0	78.6	78.2	-1.8	0.0	0.0	0.0	0.0	-0.0	-85.0	-85.0
8	500760.53	5441418.41	2.60	0	8000	77.7	77.7	0.0	0.0	78.6	279.0	-1.8	0.0	0.0	0.0	0.0	-0.0	-278.1	-278.1

Point Source, ISO 9613, Name: "Em_Inv2", ID: "Em_Inv2"																			
Nr.	X	Y	Z	Refl.	Freq.	LxT	LxN	K0	Dc	Adiv	Aatm	Agr	Afol	Ahous	Abar	Cmet	RL	LrT	LrN
	(m)	(m)	(m)		(Hz)	dB(A)	dB(A)	(dB)	(dB)	(dB)	(dB)	(dB)	(dB)	(dB)	(dB)	(dB)	(dB)	dB(A)	dB(A)
1	500552.40	5441520.21	2.60	0	63	68.1	68.1	0.0	0.0	78.6	0.3	-5.8	0.0	0.0	0.0	0.0	-0.0	-5.0	-5.0
2	500552.40	5441520.21	2.60	0	125	78.9	78.9	0.0	0.0	78.6	1.0	5.2	0.0	0.0	0.0	0.0	-0.0	-5.9	-5.9
3	500552.40	5441520.21	2.60	0	250	85.5	85.5	0.0	0.0	78.6	2.5	6.4	0.0	0.0	0.0	0.0	-0.0	-2.0	-2.0
4	500552.40	5441520.21	2.60	0	500	87.3	87.3	0.0	0.0	78.6	4.6	2.2	0.0	0.0	0.0	0.0	-0.0	1.9	1.9
5	500552.40	5441520.21	2.60	0	1000	83.7	83.7	0.0	0.0	78.6	8.8	-1.3	0.0	0.0	0.0	0.0	-0.0	-2.4	-2.4
6	500552.40	5441520.21	2.60	0	2000	79.1	79.1	0.0	0.0	78.6	23.2	-1.8	0.0	0.0	0.0	0.0	-0.0	-20.9	-20.9
7	500552.40	5441520.21	2.60	0	4000	70.0	70.0	0.0	0.0	78.6	78.6	-1.8	0.0	0.0	0.0	0.0	-0.0	-85.5	-85.5
8	500552.40	5441520.21	2.60	0	8000	77.7	77.7	0.0	0.0	78.6	280.4	-1.8	0.0	0.0	0.0	0.0	-0.0	-279.5	-279.5

Point Source, ISO 9613, Name: "Em_Inv3", ID: "Em_Inv3"																			
Nr.	X	Y	Z	Refl.	Freq.	LxT	LxN	K0	Dc	Adiv	Aatm	Agr	Afol	Ahous	Abar	Cmet	RL	LrT	LrN
	(m)	(m)	(m)		(Hz)	dB(A)	dB(A)	(dB)	(dB)	(dB)	(dB)	(dB)	(dB)	(dB)	(dB)	(dB)	(dB)	dB(A)	dB(A)
1	500760.53	5441687.21	2.60	0	63	68.1	68.1	0.0	0.0	77.6	0.3	-5.8	0.0	0.0	0.0	0.0	-0.0	-4.0	-4.0
2	500760.53	5441687.21	2.60	0	125	78.9	78.9	0.0	0.0	77.6	0.9	5.2	0.0	0.0	0.0	0.0	-0.0	-4.8	-4.8
3	500760.53	5441687.21	2.60	0	250	85.5	85.5	0.0	0.0	77.6	2.2	6.4	0.0	0.0	0.0	0.0	-0.0	-0.8	-0.8
4	500760.53	5441687.21	2.60	0	500	87.3	87.3	0.0	0.0	77.6	4.1	2.2	0.0	0.0	0.0	0.0	-0.0	3.3	3.3
5	500760.53	5441687.21	2.60	0	1000	83.7	83.7	0.0	0.0	77.6	7.9	-1.3	0.0	0.0	0.0	0.0	-0.0	-0.5	-0.5
6	500760.53	5441687.21	2.60	0	2000	79.1	79.1	0.0	0.0	77.6	20.8	-1.8	0.0	0.0	0.0	0.0	-0.0	-17.6	-17.6
7	500760.53	5441687.21	2.60	0	4000	70.0	70.0	0.0	0.0	77.6	70.4	-1.8	0.0	0.0	0.0	0.0	-0.0	-76.3	-76.3
8	500760.53	5441687.21	2.60	0	8000	77.7	77.7	0.0	0.0	77.6	251.2	-1.8	0.0	0.0	0.0	0.0	-0.0	-249.4	-249.4

Point Source, ISO 9613, Name: "Em_Inv4", ID: "Em_Inv4"																			
Nr.	X	Y	Z	Refl.	Freq.	LxT	LxN	K0	Dc	Adiv	Aatm	Agr	Afol	Ahous	Abar	Cmet	RL	LrT	LrN
	(m)	(m)	(m)		(Hz)	dB(A)	dB(A)	(dB)	(dB)	(dB)	(dB)	(dB)	(dB)	(dB)	(dB)	(dB)	(dB)	dB(A)	dB(A)
1	500516.20	5441733.01	2.60	0	63	68.1	68.1	0.0	0.0	78.0	0.3	-5.8	0.0	0.0	0.0	0.0	-0.0	-4.3	-4.3
2	500516.20	5441733.01	2.60	0	125	78.9	78.9	0.0	0.0	78.0	0.9	5.2	0.0	0.0	0.0	0.0	-0.0	-5.3	-5.3
3	500516.20	5441733.01	2.60	0	250	85.5	85.5	0.0	0.0	78.0	2.3	6.4	0.0	0.0	0.0	0.0	-0.0	-1.3	-1.3
4	500516.20	5441733.01	2.60	0	500	87.3	87.3	0.0	0.0	78.0	4.3	2.2	0.0	0.0	0.0	0.0	-0.0	2.8	2.8
5	500516.20	5441733.01	2.60	0	1000	83.7	83.7	0.0	0.0	78.0	8.2	-1.3	0.0	0.0	0.0	0.0	-0.0	-1.2	-1.2

Point Source, ISO 9613, Name: "Em_Inv4", ID: "Em_Inv4"																			
Nr.	X	Y	Z	Refl.	Freq.	LxT	LxN	K0	Dc	Adiv	Aatm	Agr	Afol	Ahous	Abar	Cmet	RL	LrT	LrN
	(m)	(m)	(m)		(Hz)	dB(A)	dB(A)	(dB)	(dB)	(dB)	(dB)	(dB)	(dB)	(dB)	(dB)	(dB)	(dB)	dB(A)	dB(A)
6	500516.20	5441733.01	2.60	0	2000	79.1	79.1	0.0	0.0	78.0	21.7	-1.8	0.0	0.0	0.0	0.0	-0.0	-18.8	-18.8
7	500516.20	5441733.01	2.60	0	4000	70.0	70.0	0.0	0.0	78.0	73.5	-1.8	0.0	0.0	0.0	0.0	-0.0	-79.7	-79.7
8	500516.20	5441733.01	2.60	0	8000	77.7	77.7	0.0	0.0	78.0	262.0	-1.8	0.0	0.0	0.0	0.0	-0.0	-260.5	-260.5

Point Source, ISO 9613, Name: "Em_Inv5", ID: "Em_Inv5"																			
Nr.	X	Y	Z	Refl.	Freq.	LxT	LxN	K0	Dc	Adiv	Aatm	Agr	Afol	Ahous	Abar	Cmet	RL	LrT	LrN
	(m)	(m)	(m)		(Hz)	dB(A)	dB(A)	(dB)	(dB)	(dB)	(dB)	(dB)	(dB)	(dB)	(dB)	(dB)	(dB)	dB(A)	dB(A)
1	500760.53	5441956.01	2.60	0	63	68.1	68.1	0.0	0.0	76.7	0.2	-5.8	0.0	0.0	0.0	0.0	-0.0	-3.0	-3.0
2	500760.53	5441956.01	2.60	0	125	78.9	78.9	0.0	0.0	76.7	0.8	5.2	0.0	0.0	0.0	0.0	-0.0	-3.8	-3.8
3	500760.53	5441956.01	2.60	0	250	85.5	85.5	0.0	0.0	76.7	2.0	6.5	0.0	0.0	0.0	0.0	-0.0	0.4	0.4
4	500760.53	5441956.01	2.60	0	500	87.3	87.3	0.0	0.0	76.7	3.7	2.2	0.0	0.0	0.0	0.0	-0.0	4.8	4.8
5	500760.53	5441956.01	2.60	0	1000	83.7	83.7	0.0	0.0	76.7	7.0	-1.3	0.0	0.0	0.0	0.0	-0.0	1.3	1.3
6	500760.53	5441956.01	2.60	0	2000	79.1	79.1	0.0	0.0	76.7	18.6	-1.7	0.0	0.0	0.0	0.0	-0.0	-14.4	-14.4
7	500760.53	5441956.01	2.60	0	4000	70.0	70.0	0.0	0.0	76.7	62.9	-1.7	0.0	0.0	0.0	0.0	-0.0	-67.8	-67.8
8	500760.53	5441956.01	2.60	0	8000	77.7	77.7	0.0	0.0	76.7	224.3	-1.7	0.0	0.0	0.0	0.0	-0.0	-221.6	-221.6

Point Source, ISO 9613, Name: "Em_Inv6", ID: "Em_Inv6"																			
Nr.	X	Y	Z	Refl.	Freq.	LxT	LxN	K0	Dc	Adiv	Aatm	Agr	Afol	Ahous	Abar	Cmet	RL	LrT	LrN
	(m)	(m)	(m)		(Hz)	dB(A)	dB(A)	(dB)	(dB)	(dB)	(dB)	(dB)	(dB)	(dB)	(dB)	(dB)	(dB)	dB(A)	dB(A)
1	500498.10	5441901.01	2.60	0	63	68.1	68.1	0.0	0.0	77.5	0.3	-5.8	0.0	0.0	0.0	0.0	-0.0	-3.8	-3.8
2	500498.10	5441901.01	2.60	0	125	78.9	78.9	0.0	0.0	77.5	0.9	5.2	0.0	0.0	0.0	0.0	-0.0	-4.7	-4.7
3	500498.10	5441901.01	2.60	0	250	85.5	85.5	0.0	0.0	77.5	2.2	6.4	0.0	0.0	0.0	0.0	-0.0	-0.7	-0.7
4	500498.10	5441901.01	2.60	0	500	87.3	87.3	0.0	0.0	77.5	4.1	2.2	0.0	0.0	0.0	0.0	-0.0	3.5	3.5
5	500498.10	5441901.01	2.60	0	1000	83.7	83.7	0.0	0.0	77.5	7.8	-1.3	0.0	0.0	0.0	0.0	-0.0	-0.3	-0.3
6	500498.10	5441901.01	2.60	0	2000	79.1	79.1	0.0	0.0	77.5	20.5	-1.8	0.0	0.0	0.0	0.0	-0.0	-17.1	-17.1
7	500498.10	5441901.01	2.60	0	4000	70.0	70.0	0.0	0.0	77.5	69.4	-1.8	0.0	0.0	0.0	0.0	-0.0	-75.2	-75.2
8	500498.10	5441901.01	2.60	0	8000	77.7	77.7	0.0	0.0	77.5	247.5	-1.8	0.0	0.0	0.0	0.0	-0.0	-245.6	-245.6

Point Source, ISO 9613, Name: "Em_Inv7", ID: "Em_Inv7"																			
Nr.	X	Y	Z	Refl.	Freq.	LxT	LxN	K0	Dc	Adiv	Aatm	Agr	Afol	Ahous	Abar	Cmet	RL	LrT	LrN
	(m)	(m)	(m)		(Hz)	dB(A)	dB(A)	(dB)	(dB)	(dB)	(dB)	(dB)	(dB)	(dB)	(dB)	(dB)	(dB)	dB(A)	dB(A)
1	500498.10	5442057.81	2.60	0	63	68.1	68.1	0.0	0.0	77.0	0.2	-5.8	0.0	0.0	0.0	0.0	-0.0	-3.3	-3.3
2	500498.10	5442057.81	2.60	0	125	78.9	78.9	0.0	0.0	77.0	0.8	5.2	0.0	0.0	0.0	0.0	-0.0	-4.1	-4.1
3	500498.10	5442057.81	2.60	0	250	85.5	85.5	0.0	0.0	77.0	2.1	6.5	0.0	0.0	0.0	0.0	-0.0	-0.0	-0.0
4	500498.10	5442057.81	2.60	0	500	87.3	87.3	0.0	0.0	77.0	3.8	2.2	0.0	0.0	0.0	0.0	-0.0	4.3	4.3
5	500498.10	5442057.81	2.60	0	1000	83.7	83.7	0.0	0.0	77.0	7.3	-1.3	0.0	0.0	0.0	0.0	-0.0	0.7	0.7
6	500498.10	5442057.81	2.60	0	2000	79.1	79.1	0.0	0.0	77.0	19.3	-1.7	0.0	0.0	0.0	0.0	-0.0	-15.5	-15.5
7	500498.10	5442057.81	2.60	0	4000	70.0	70.0	0.0	0.0	77.0	65.5	-1.7	0.0	0.0	0.0	0.0	-0.0	-70.7	-70.7
8	500498.10	5442057.81	2.60	0	8000	77.7	77.7	0.0	0.0	77.0	233.5	-1.7	0.0	0.0	0.0	0.0	-0.0	-231.0	-231.0

Point Source, ISO 9613, Name: "Em_Inv8", ID: "Em_Inv8"																			
Nr.	X	Y	Z	Refl.	Freq.	LxT	LxN	K0	Dc	Adiv	Aatm	Agr	Afol	Ahous	Abar	Cmet	RL	LrT	LrN
	(m)	(m)	(m)		(Hz)	dB(A)	dB(A)	(dB)	(dB)	(dB)	(dB)	(dB)	(dB)	(dB)	(dB)	(dB)	(dB)	dB(A)	dB(A)
1	500461.90	5442281.81	2.60	0	63	68.1	68.1	0.0	0.0	76.4	0.2	-5.8	0.0	0.0	0.0	0.0	-0.0	-2.7	-2.7
2	500461.90	5442281.81	2.60	0	125	78.9	78.9	0.0	0.0	76.4	0.8	5.2	0.0	0.0	0.0	0.0	-0.0	-3.5	-3.5
3	500461.90	5442281.81	2.60	0	250	85.5	85.5	0.0	0.0	76.4	1.9	6.5	0.0	0.0	0.0	0.0	-0.0	0.7	0.7
4	500461.90	5442281.81	2.60	0	500	87.3	87.3	0.0	0.0	76.4	3.6	2.2	0.0	0.0	0.0	0.0	-0.0	5.1	5.1
5	500461.90	5442281.81	2.60	0	1000	83.7	83.7	0.0	0.0	76.4	6.8	-1.3	0.0	0.0	0.0	0.0	-0.0	1.8	1.8
6	500461.90	5442281.81	2.60	0	2000	79.1	79.1	0.0	0.0	76.4	18.0	-1.7	0.0	0.0	0.0	0.0	-0.0	-13.5	-13.5
7	500461.90	5442281.81	2.60	0	4000	70.0	70.0	0.0	0.0	76.4	61.0	-1.7	0.0	0.0	0.0	0.0	-0.0	-65.6	-65.6
8	500461.90	5442281.81	2.60	0	8000	77.7	77.7	0.0	0.0	76.4	217.5	-1.7	0.0	0.0	0.0	0.0	-0.0	-214.5	-214.5

Point Source, ISO 9613, Name: "Em_Inv9", ID: "Em_Inv9"																			
Nr.	X	Y	Z	Refl.	Freq.	LxT	LxN	K0	Dc	Adiv	Aatm	Agr	Afol	Ahous	Abar	Cmet	RL	LrT	LrN
	(m)	(m)	(m)		(Hz)	dB(A)	dB(A)	(dB)	(dB)	(dB)	(dB)	(dB)	(dB)	(dB)	(dB)	(dB)	(dB)	dB(A)	dB(A)
1	500651.93	5442280.81	2.60	0	63	68.1	68.1	0.0	0.0	75.8	0.2	-5.8	0.0	0.0	0.0	0.0	-0.0	-2.1	-2.1
2	500651.93	5442280.81	2.60	0	125	78.9	78.9	0.0	0.0	75.8	0.7	5.2	0.0	0.0	0.0	0.0	-0.0	-2.8	-2.8
3	500651.93	5442280.81	2.60	0	250	85.5	85.5	0.0	0.0	75.8	1.8	6.5	0.0	0.0	0.0	0.0	-0.0	1.5	1.5
4	500651.93	5442280.81	2.60	0	500	87.3	87.3	0.0	0.0	75.8	3.3	2.2	0.0	0.0	0.0	0.0	-0.0	6.0	6.0
5	500651.93	5442280.81	2.60	0	1000	83.7	83.7	0.0	0.0	75.8	6.3	-1.3	0.0	0.0	0.0	0.0	-0.0	2.9	2.9
6	500651.93	5442280.81	2.60	0	2000	79.1	79.1	0.0	0.0	75.8	16.7	-1.7	0.0	0.0	0.0	0.0	-0.0	-11.6	-11.6
7	500651.93	5442280.81	2.60	0	4000	70.0	70.0	0.0	0.0	75.8	56.6	-1.7	0.0	0.0	0.0	0.0	-0.0	-60.7	-60.7
8	500651.93	5442280.81	2.60	0	8000	77.7	77.7	0.0	0.0	75.8	202.0	-1.7	0.0	0.0	0.0	0.0	-0.0	-198.4	-198.4

Point Source, ISO 9613, Name: "Em_Inv10", ID: "Em_Inv10"																			
Nr.	X	Y	Z	Refl.	Freq.	LxT	LxN	K0	Dc	Adiv	Aatm	Agr	Afol	Ahous	Abar	Cmet	RL	LrT	LrN
	(m)	(m)	(m)		(Hz)	dB(A)	dB(A)	(dB)	(dB)	(dB)	(dB)	(dB)	(dB)	(dB)	(dB)	(dB)	(dB)	dB(A)	dB(A)
1	499992.71	5441665.81	2.60	0	63	68.1	68.1	0.0	0.0	79.4	0.3	-5.9	0.0	0.0	0.0	0.0	-0.0	-5.8	-5.8
2	499992.71	5441665.81	2.60	0	125	78.9	78.9	0.0	0.0	79.4	1.1	5.2	0.0	0.0	0.0	0.0	-0.0	-6.8	-6.8
3	499992.71	5441665.81	2.60	0	250	85.5	85.5	0.0	0.0	79.4	2.7	6.4	0.0	0.0	0.0	0.0	-0.0	-3.1	-3.1
4	499992.71	5441665.81	2.60	0	500	87.3	87.3	0.0	0.0	79.4	5.1	2.2	0.0	0.0	0.0	0.0	-0.0	0.7	0.7
5	499992.71	5441665.81	2.60	0	1000	83.7	83.7	0.0	0.0	79.4	9.6	-1.3	0.0	0.0	0.0	0.0	-0.0	-4.0	-4.0
6	499992.71	5441665.81	2.60	0	2000	79.1	79.1	0.0	0.0	79.4	25.4	-1.8	0.0	0.0	0.0	0.0	-0.0	-23.9	-23.9
7	499992.71	5441665.81	2.60	0	4000	70.0	70.0	0.0	0.0	79.4	86.1	-1.8	0.0	0.0	0.0	0.0	-0.0	-93.8	-93.8
8	499992.71	5441665.81	2.60	0	8000	77.7	77.7	0.0	0.0	79.4	307.2	-1.8	0.0	0.0	0.0	0.0	-0.0	-307.1	-307.1

Point Source, ISO 9613, Name: "Em_Inv11", ID: "Em_Inv11"																			
Nr.	X	Y	Z	Refl.	Freq.	LxT	LxN	K0	Dc	Adiv	Aatm	Agr	Afol	Ahous	Abar	Cmet	RL	LrT	LrN
	(m)	(m)	(m)		(Hz)	dB(A)	dB(A)	(dB)	(dB)	(dB)	(dB)	(dB)	(dB)	(dB)	(dB)	(dB)	(dB)	dB(A)	dB(A)
1	499992.71	5441505.71	2.60	0	63	68.1	68.1	0.0	0.0	79.8	0.3	-5.9	0.0	0.0	0.0	0.0	-0.0	-6.1	-6.1
2	499992.71	5441505.71	2.60	0	125	78.9	78.9	0.0	0.0	79.8	1.1	5.2	0.0	0.0	0.0	0.0	-0.0	-7.2	-7.2
3	499992.71	5441505.71	2.60	0	250	85.5	85.5	0.0	0.0	79.8	2.9	6.4	0.0	0.0	0.0	0.0	-0.0	-3.6	-3.6
4	499992.71	5441505.71	2.60	0	500	87.3	87.3	0.0	0.0	79.8	5.3	2.2	0.0	0.0	0.0	0.0	-0.0	0.1	0.1
5	499992.71	5441505.71	2.60	0	1000	83.7	83.7	0.0	0.0	79.8	10.0	-1.3	0.0	0.0	0.0	0.0	-0.0	-4.8	-4.8
6	499992.71	5441505.71	2.60	0	2000	79.1	79.1	0.0	0.0	79.8	26.5	-1.8	0.0	0.0	0.0	0.0	-0.0	-25.4	-25.4
7	499992.71	5441505.71	2.60	0	4000	70.0	70.0	0.0	0.0	79.8	90.0	-1.8	0.0	0.0	0.0	0.0	-0.0	-98.0	-98.0
8	499992.71	5441505.71	2.60	0	8000	77.7	77.7	0.0	0.0	79.8	320.9	-1.8	0.0	0.0	0.0	0.0	-0.0	-321.2	-321.2

Point Source, ISO 9613, Name: "Em_Trans1", ID: "Em_Trans1"																			
Nr.	X	Y	Z	Refl.	Freq.	LxT	LxN	K0	Dc	Adiv	Aatm	Agr	Afol	Ahous	Abar	Cmet	RL	LrT	LrN
	(m)	(m)	(m)		(Hz)	dB(A)	dB(A)	(dB)	(dB)	(dB)	(dB)	(dB)	(dB)	(dB)	(dB)	(dB)	(dB)	dB(A)	dB(A)
1	500755.03	5441418.91	2.58	0	32	37.3	37.3	0.0	0.0	78.6	0.1	-5.8	0.0	0.0	0.0	0.0	-0.0	-35.5	-35.5
2	500755.03	5441418.91	2.58	0	63	56.5	56.5	0.0	0.0	78.6	0.3	-5.8	0.0	0.0	0.0	0.0	-0.0	-16.5	-16.5
3	500755.03	5441418.91	2.58	0	125	68.6	68.6	0.0	0.0	78.6	1.0	5.2	0.0	0.0	0.0	0.0	-0.0	-16.2	-16.2
4	500755.03	5441418.91	2.58	0	250	71.1	71.1	0.0	0.0	78.6	2.5	6.5	0.0	0.0	0.0	0.0	-0.0	-16.4	-16.4
5	500755.03	5441418.91	2.58	0	500	76.5	76.5	0.0	0.0	78.6	4.6	2.2	0.0	0.0	0.0	0.0	-0.0	-8.9	-8.9
6	500755.03	5441418.91	2.58	0	1000	73.7	73.7	0.0	0.0	78.6	8.7	-1.3	0.0	0.0	0.0	0.0	-0.0	-12.3	-12.3
7	500755.03	5441418.91	2.58	0	2000	69.9	69.9	0.0	0.0	78.6	23.1	-1.8	0.0	0.0	0.0	0.0	-0.0	-30.0	-30.0
8	500755.03	5441418.91	2.58	0	4000	64.7	64.7	0.0	0.0	78.6	78.3	-1.8	0.0	0.0	0.0	0.0	-0.0	-90.4	-90.4
9	500755.03	5441418.91	2.58	0	8000	55.6	55.6	0.0	0.0	78.6	279.2	-1.8	0.0	0.0	0.0	0.0	-0.0	-300.4	-300.4

Point Source, ISO 9613, Name: "Em_Trans2", ID: "Em_Trans2"																			
Nr.	X	Y	Z	Refl.	Freq.	LxT	LxN	K0	Dc	Adiv	Aatm	Agr	Afol	Ahous	Abar	Cmet	RL	LrT	LrN
	(m)	(m)	(m)		(Hz)	dB(A)	dB(A)	(dB)	(dB)	(dB)	(dB)	(dB)	(dB)	(dB)	(dB)	(dB)	(dB)	dB(A)	dB(A)
1	500557.90	5441519.71	2.58	0	32	37.3	37.3	0.0	0.0	78.6	0.1	-5.8	0.0	0.0	0.0	0.0	-0.0	-35.5	-35.5
2	500557.90	5441519.71	2.58	0	63	56.5	56.5	0.0	0.0	78.6	0.3	-5.8	0.0	0.0	0.0	0.0	-0.0	-16.5	-16.5
3	500557.90	5441519.71	2.58	0	125	68.6	68.6	0.0	0.0	78.6	1.0	5.2	0.0	0.0	0.0	0.0	-0.0	-16.2	-16.2
4	500557.90	5441519.71	2.58	0	250	71.1	71.1	0.0	0.0	78.6	2.5	6.5	0.0	0.0	0.0	0.0	-0.0	-16.5	-16.5
5	500557.90	5441519.71	2.58	0	500	76.5	76.5	0.0	0.0	78.6	4.6	2.2	0.0	0.0	0.0	0.0	-0.0	-8.9	-8.9
6	500557.90	5441519.71	2.58	0	1000	73.7	73.7	0.0	0.0	78.6	8.8	-1.3	0.0	0.0	0.0	0.0	-0.0	-12.4	-12.4
7	500557.90	5441519.71	2.58	0	2000	69.9	69.9	0.0	0.0	78.6	23.2	-1.8	0.0	0.0	0.0	0.0	-0.0	-30.1	-30.1
8	500557.90	5441519.71	2.58	0	4000	64.7	64.7	0.0	0.0	78.6	78.5	-1.8	0.0	0.0	0.0	0.0	-0.0	-90.7	-90.7
9	500557.90	5441519.71	2.58	0	8000	55.6	55.6	0.0	0.0	78.6	280.1	-1.8	0.0	0.0	0.0	0.0	-0.0	-301.3	-301.3

Point Source, ISO 9613, Name: "Em_Trans3", ID: "Em_Trans3"																			
Nr.	X	Y	Z	Refl.	Freq.	LxT	LxN	K0	Dc	Adiv	Aatm	Agr	Afol	Ahous	Abar	Cmet	RL	LrT	LrN
	(m)	(m)	(m)		(Hz)	dB(A)	dB(A)	(dB)	(dB)	(dB)	(dB)	(dB)	(dB)	(dB)	(dB)	(dB)	(dB)	dB(A)	dB(A)
1	500755.03	5441687.71	2.58	0	32	37.3	37.3	0.0	0.0	77.6	0.1	-5.8	0.0	0.0	0.0	0.0	-0.0	-34.6	-34.6
2	500755.03	5441687.71	2.58	0	63	56.5	56.5	0.0	0.0	77.6	0.3	-5.8	0.0	0.0	0.0	0.0	-0.0	-15.6	-15.6
3	500755.03	5441687.71	2.58	0	125	68.6	68.6	0.0	0.0	77.6	0.9	5.2	0.0	0.0	0.0	0.0	-0.0	-15.2	-15.2
4	500755.03	5441687.71	2.58	0	250	71.1	71.1	0.0	0.0	77.6	2.2	6.5	0.0	0.0	0.0	0.0	-0.0	-15.3	-15.3
5	500755.03	5441687.71	2.58	0	500	76.5	76.5	0.0	0.0	77.6	4.1	2.2	0.0	0.0	0.0	0.0	-0.0	-7.5	-7.5
6	500755.03	5441687.71	2.58	0	1000	73.7	73.7	0.0	0.0	77.6	7.9	-1.3	0.0	0.0	0.0	0.0	-0.0	-10.5	-10.5
7	500755.03	5441687.71	2.58	0	2000	69.9	69.9	0.0	0.0	77.6	20.8	-1.8	0.0	0.0	0.0	0.0	-0.0	-26.8	-26.8
8	500755.03	5441687.71	2.58	0	4000	64.7	64.7	0.0	0.0	77.6	70.5	-1.8	0.0	0.0	0.0	0.0	-0.0	-81.7	-81.7
9	500755.03	5441687.71	2.58	0	8000	55.6	55.6	0.0	0.0	77.6	251.4	-1.8	0.0	0.0	0.0	0.0	-0.0	-271.8	-271.8

Point Source, ISO 9613, Name: "Em_Trans4", ID: "Em_Trans4"																			
Nr.	X	Y	Z	Refl.	Freq.	LxT	LxN	K0	Dc	Adiv	Aatm	Agr	Afol	Ahous	Abar	Cmet	RL	LrT	LrN
	(m)	(m)	(m)		(Hz)	dB(A)	dB(A)	(dB)	(dB)	(dB)	(dB)	(dB)	(dB)	(dB)	(dB)	(dB)	(dB)	dB(A)	dB(A)
1	500521.70	5441732.51	2.58	0	32	37.3	37.3	0.0	0.0	78.0	0.1	-5.8	0.0	0.0	0.0	0.0	-0.0	-34.9	-34.9
2	500521.70	5441732.51	2.58	0	63	56.5	56.5	0.0	0.0	78.0	0.3	-5.8	0.0	0.0	0.0	0.0	-0.0	-15.9	-15.9
3	500521.70	5441732.51	2.58	0	125	68.6	68.6	0.0	0.0	78.0	0.9	5.2	0.0	0.0	0.0	0.0	-0.0	-15.5	-15.5
4	500521.70	5441732.51	2.58	0	250	71.1	71.1	0.0	0.0	78.0	2.3	6.5	0.0	0.0	0.0	0.0	-0.0	-15.7	-15.7
5	500521.70	5441732.51	2.58	0	500	76.5	76.5	0.0	0.0	78.0	4.3	2.2	0.0	0.0	0.0	0.0	-0.0	-8.0	-8.0
6	500521.70	5441732.51	2.58	0	1000	73.7	73.7	0.0	0.0	78.0	8.2	-1.3	0.0	0.0	0.0	0.0	-0.0	-11.2	-11.2
7	500521.70	5441732.51	2.58	0	2000	69.9	69.9	0.0	0.0	78.0	21.6	-1.8	0.0	0.0	0.0	0.0	-0.0	-28.0	-28.0
8	500521.70	5441732.51	2.58	0	4000	64.7	64.7	0.0	0.0	78.0	73.4	-1.8	0.0	0.0	0.0	0.0	-0.0	-84.9	-84.9
9	500521.70	5441732.51	2.58	0	8000	55.6	55.6	0.0	0.0	78.0	261.6	-1.8	0.0	0.0	0.0	0.0	-0.0	-282.3	-282.3

Point Source, ISO 9613, Name: "Em_Trans5", ID: "Em_Trans5"																			
Nr.	X	Y	Z	Refl.	Freq.	LxT	LxN	K0	Dc	Adiv	Aatm	Agr	Afol	Ahous	Abar	Cmet	RL	LrT	LrN
	(m)	(m)	(m)		(Hz)	dB(A)	dB(A)	(dB)	(dB)	(dB)	(dB)	(dB)	(dB)	(dB)	(dB)	(dB)	(dB)	dB(A)	dB(A)
1	500755.03	5441956.51	2.58	0	32	37.3	37.3	0.0	0.0	76.7	0.1	-5.8	0.0	0.0	0.0	0.0	-0.0	-33.6	-33.6
2	500755.03	5441956.51	2.58	0	63	56.5	56.5	0.0	0.0	76.7	0.2	-5.8	0.0	0.0	0.0	0.0	-0.0	-14.6	-14.6
3	500755.03	5441956.51	2.58	0	125	68.6	68.6	0.0	0.0	76.7	0.8	5.2	0.0	0.0	0.0	0.0	-0.0	-14.1	-14.1
4	500755.03	5441956.51	2.58	0	250	71.1	71.1	0.0	0.0	76.7	2.0	6.5	0.0	0.0	0.0	0.0	-0.0	-14.1	-14.1
5	500755.03	5441956.51	2.58	0	500	76.5	76.5	0.0	0.0	76.7	3.7	2.2	0.0	0.0	0.0	0.0	-0.0	-6.1	-6.1
6	500755.03	5441956.51	2.58	0	1000	73.7	73.7	0.0	0.0	76.7	7.0	-1.3	0.0	0.0	0.0	0.0	-0.0	-8.7	-8.7
7	500755.03	5441956.51	2.58	0	2000	69.9	69.9	0.0	0.0	76.7	18.6	-1.7	0.0	0.0	0.0	0.0	-0.0	-23.6	-23.6
8	500755.03	5441956.51	2.58	0	4000	64.7	64.7	0.0	0.0	76.7	63.0	-1.7	0.0	0.0	0.0	0.0	-0.0	-73.2	-73.2
9	500755.03	5441956.51	2.58	0	8000	55.6	55.6	0.0	0.0	76.7	224.6	-1.7	0.0	0.0	0.0	0.0	-0.0	-244.0	-244.0

Point Source, ISO 9613, Name: "Em_Trans6", ID: "Em_Trans6"																			
Nr.	X	Y	Z	Refl.	Freq.	LxT	LxN	K0	Dc	Adiv	Aatm	Agr	Afol	Ahous	Abar	Cmet	RL	LrT	LrN
	(m)	(m)	(m)		(Hz)	dB(A)	dB(A)	(dB)	(dB)	(dB)	(dB)	(dB)	(dB)	(dB)	(dB)	(dB)	(dB)	dB(A)	dB(A)
1	500503.60	5441900.51	2.58	0	32	37.3	37.3	0.0	0.0	77.5	0.1	-5.8	0.0	0.0	0.0	0.0	-0.0	-34.4	-34.4
2	500503.60	5441900.51	2.58	0	63	56.5	56.5	0.0	0.0	77.5	0.3	-5.8	0.0	0.0	0.0	0.0	-0.0	-15.4	-15.4
3	500503.60	5441900.51	2.58	0	125	68.6	68.6	0.0	0.0	77.5	0.9	5.2	0.0	0.0	0.0	0.0	-0.0	-15.0	-15.0
4	500503.60	5441900.51	2.58	0	250	71.1	71.1	0.0	0.0	77.5	2.2	6.5	0.0	0.0	0.0	0.0	-0.0	-15.1	-15.1
5	500503.60	5441900.51	2.58	0	500	76.5	76.5	0.0	0.0	77.5	4.1	2.2	0.0	0.0	0.0	0.0	-0.0	-7.3	-7.3
6	500503.60	5441900.51	2.58	0	1000	73.7	73.7	0.0	0.0	77.5	7.7	-1.3	0.0	0.0	0.0	0.0	-0.0	-10.3	-10.3
7	500503.60	5441900.51	2.58	0	2000	69.9	69.9	0.0	0.0	77.5	20.4	-1.8	0.0	0.0	0.0	0.0	-0.0	-26.3	-26.3
8	500503.60	5441900.51	2.58	0	4000	64.7	64.7	0.0	0.0	77.5	69.3	-1.8	0.0	0.0	0.0	0.0	-0.0	-80.4	-80.4
9	500503.60	5441900.51	2.58	0	8000	55.6	55.6	0.0	0.0	77.5	247.2	-1.8	0.0	0.0	0.0	0.0	-0.0	-267.3	-267.3

Point Source, ISO 9613, Name: "Em_Trans7", ID: "Em_Trans7"																			
Nr.	X	Y	Z	Refl.	Freq.	LxT	LxN	K0	Dc	Adiv	Aatm	Agr	Afol	Ahous	Abar	Cmet	RL	LrT	LrN
	(m)	(m)	(m)		(Hz)	dB(A)	dB(A)	(dB)	(dB)	(dB)	(dB)	(dB)	(dB)	(dB)	(dB)	(dB)	(dB)	dB(A)	dB(A)
1	500503.60	5442057.31	2.58	0	32	37.3	37.3	0.0	0.0	77.0	0.1	-5.8	0.0	0.0	0.0	0.0	-0.0	-33.9	-33.9
2	500503.60	5442057.31	2.58	0	63	56.5	56.5	0.0	0.0	77.0	0.2	-5.8	0.0	0.0	0.0	0.0	-0.0	-14.9	-14.9
3	500503.60	5442057.31	2.58	0	125	68.6	68.6	0.0	0.0	77.0	0.8	5.2	0.0	0.0	0.0	0.0	-0.0	-14.4	-14.4
4	500503.60	5442057.31	2.58	0	250	71.1	71.1	0.0	0.0	77.0	2.1	6.5	0.0	0.0	0.0	0.0	-0.0	-14.5	-14.5
5	500503.60	5442057.31	2.58	0	500	76.5	76.5	0.0	0.0	77.0	3.8	2.2	0.0	0.0	0.0	0.0	-0.0	-6.5	-6.5
6	500503.60	5442057.31	2.58	0	1000	73.7	73.7	0.0	0.0	77.0	7.3	-1.3	0.0	0.0	0.0	0.0	-0.0	-9.3	-9.3
7	500503.60	5442057.31	2.58	0	2000	69.9	69.9	0.0	0.0	77.0	19.3	-1.7	0.0	0.0	0.0	0.0	-0.0	-24.6	-24.6
8	500503.60	5442057.31	2.58	0	4000	64.7	64.7	0.0	0.0	77.0	65.3	-1.7	0.0	0.0	0.0	0.0	-0.0	-75.9	-75.9
9	500503.60	5442057.31	2.58	0	8000	55.6	55.6	0.0	0.0	77.0	233.1	-1.7	0.0	0.0	0.0	0.0	-0.0	-252.7	-252.7

Point Source, ISO 9613, Name: "Em_Trans8", ID: "Em_Trans8"																			
Nr.	X	Y	Z	Refl.	Freq.	LxT	LxN	K0	Dc	Adiv	Aatm	Agr	Afol	Ahous	Abar	Cmet	RL	LrT	LrN
	(m)	(m)	(m)		(Hz)	dB(A)	dB(A)	(dB)	(dB)	(dB)	(dB)	(dB)	(dB)	(dB)	(dB)	(dB)	(dB)	dB(A)	dB(A)
1	500467.40	5442281.31	2.58	0	32	37.3	37.3	0.0	0.0	76.4	0.1	-5.8	0.0	0.0	0.0	0.0	-0.0	-33.3	-33.3
2	500467.40	5442281.31	2.58	0	63	56.5	56.5	0.0	0.0	76.4	0.2	-5.8	0.0	0.0	0.0	0.0	-0.0	-14.3	-14.3
3	500467.40	5442281.31	2.58	0	125	68.6	68.6	0.0	0.0	76.4	0.8	5.2	0.0	0.0	0.0	0.0	-0.0	-13.8	-13.8
4	500467.40	5442281.31	2.58	0	250	71.1	71.1	0.0	0.0	76.4	1.9	6.5	0.0	0.0	0.0	0.0	-0.0	-13.7	-13.7
5	500467.40	5442281.31	2.58	0	500	76.5	76.5	0.0	0.0	76.4	3.6	2.2	0.0	0.0	0.0	0.0	-0.0	-5.7	-5.7
6	500467.40	5442281.31	2.58	0	1000	73.7	73.7	0.0	0.0	76.4	6.8	-1.3	0.0	0.0	0.0	0.0	-0.0	-8.2	-8.2
7	500467.40	5442281.31	2.58	0	2000	69.9	69.9	0.0	0.0	76.4	17.9	-1.7	0.0	0.0	0.0	0.0	-0.0	-22.7	-22.7
8	500467.40	5442281.31	2.58	0	4000	64.7	64.7	0.0	0.0	76.4	60.9	-1.7	0.0	0.0	0.0	0.0	-0.0	-70.8	-70.8
9	500467.40	5442281.31	2.58	0	8000	55.6	55.6	0.0	0.0	76.4	217.1	-1.7	0.0	0.0	0.0	0.0	-0.0	-236.1	-236.1

Point Source, ISO 9613, Name: "Em_Trans9", ID: "Em_Trans9"																			
Nr.	X	Y	Z	Refl.	Freq.	LxT	LxN	K0	Dc	Adiv	Aatm	Agr	Afol	Ahous	Abar	Cmet	RL	LrT	LrN
	(m)	(m)	(m)		(Hz)	dB(A)	dB(A)	(dB)	(dB)	(dB)	(dB)	(dB)	(dB)	(dB)	(dB)	(dB)	(dB)	dB(A)	dB(A)
1	500646.43	5442281.31	2.58	0	32	37.3	37.3	0.0	0.0	75.8	0.1	-5.8	0.0	0.0	0.0	0.0	-0.0	-32.7	-32.7
2	500646.43	5442281.31	2.58	0	63	56.5	56.5	0.0	0.0	75.8	0.2	-5.8	0.0	0.0	0.0	0.0	-0.0	-13.7	-13.7
3	500646.43	5442281.31	2.58	0	125	68.6	68.6	0.0	0.0	75.8	0.7	5.2	0.0	0.0	0.0	0.0	-0.0	-13.1	-13.1
4	500646.43	5442281.31	2.58	0	250	71.1	71.1	0.0	0.0	75.8	1.8	6.5	0.0	0.0	0.0	0.0	-0.0	-13.0	-13.0
5	500646.43	5442281.31	2.58	0	500	76.5	76.5	0.0	0.0	75.8	3.3	2.2	0.0	0.0	0.0	0.0	-0.0	-4.8	-4.8
6	500646.43	5442281.31	2.58	0	1000	73.7	73.7	0.0	0.0	75.8	6.3	-1.3	0.0	0.0	0.0	0.0	-0.0	-7.1	-7.1
7	500646.43	5442281.31	2.58	0	2000	69.9	69.9	0.0	0.0	75.8	16.7	-1.7	0.0	0.0	0.0	0.0	-0.0	-20.9	-20.9
8	500646.43	5442281.31	2.58	0	4000	64.7	64.7	0.0	0.0	75.8	56.8	-1.7	0.0	0.0	0.0	0.0	-0.0	-66.1	-66.1
9	500646.43	5442281.31	2.58	0	8000	55.6	55.6	0.0	0.0	75.8	202.4	-1.7	0.0	0.0	0.0	0.0	-0.0	-220.9	-220.9

Point Source, ISO 9613, Name: "Em_Trans10", ID: "Em_Trans10"																			
Nr.	X	Y	Z	Refl.	Freq.	LxT	LxN	K0	Dc	Adiv	Aatm	Agr	Afol	Ahous	Abar	Cmet	RL	LrT	LrN
	(m)	(m)	(m)		(Hz)	dB(A)	dB(A)	(dB)	(dB)	(dB)	(dB)	(dB)	(dB)	(dB)	(dB)	(dB)	(dB)	dB(A)	dB(A)
1	499998.21	5441665.31	2.58	0	32	37.3	37.3	0.0	0.0	79.4	0.1	-5.9	0.0	0.0	0.0	0.0	-0.0	-36.3	-36.3
2	499998.21	5441665.31	2.58	0	63	56.5	56.5	0.0	0.0	79.4	0.3	-5.9	0.0	0.0	0.0	0.0	-0.0	-17.3	-17.3
3	499998.21	5441665.31	2.58	0	125	68.6	68.6	0.0	0.0	79.4	1.1	5.2	0.0	0.0	0.0	0.0	-0.0	-17.1	-17.1
4	499998.21	5441665.31	2.58	0	250	71.1	71.1	0.0	0.0	79.4	2.7	6.5	0.0	0.0	0.0	0.0	-0.0	-17.5	-17.5
5	499998.21	5441665.31	2.58	0	500	76.5	76.5	0.0	0.0	79.4	5.1	2.2	0.0	0.0	0.0	0.0	-0.0	-10.1	-10.1
6	499998.21	5441665.31	2.58	0	1000	73.7	73.7	0.0	0.0	79.4	9.6	-1.3	0.0	0.0	0.0	0.0	-0.0	-14.0	-14.0
7	499998.21	5441665.31	2.58	0	2000	69.9	69.9	0.0	0.0	79.4	25.4	-1.8	0.0	0.0	0.0	0.0	-0.0	-33.1	-33.1
8	499998.21	5441665.31	2.58	0	4000	64.7	64.7	0.0	0.0	79.4	86.0	-1.8	0.0	0.0	0.0	0.0	-0.0	-98.9	-98.9
9	499998.21	5441665.31	2.58	0	8000	55.6	55.6	0.0	0.0	79.4	306.8	-1.8	0.0	0.0	0.0	0.0	-0.0	-328.8	-328.8

Point Source, ISO 9613, Name: "Em_Trans11", ID: "Em_Trans11"																			
Nr.	X	Y	Z	Refl.	Freq.	LxT	LxN	K0	Dc	Adiv	Aatm	Agr	Afol	Ahous	Abar	Cmet	RL	LrT	LrN
	(m)	(m)	(m)		(Hz)	dB(A)	dB(A)	(dB)	(dB)	(dB)	(dB)	(dB)	(dB)	(dB)	(dB)	(dB)	(dB)	dB(A)	dB(A)
1	499998.21	5441505.21	2.58	0	32	37.3	37.3	0.0	0.0	79.8	0.1	-5.9	0.0	0.0	0.0	0.0	-0.0	-36.7	-36.7
2	499998.21	5441505.21	2.58	0	63	56.5	56.5	0.0	0.0	79.8	0.3	-5.9	0.0	0.0	0.0	0.0	-0.0	-17.7	-17.7
3	499998.21	5441505.21	2.58	0	125	68.6	68.6	0.0	0.0	79.8	1.1	5.2	0.0	0.0	0.0	0.0	-0.0	-17.5	-17.5
4	499998.21	5441505.21	2.58	0	250	71.1	71.1	0.0	0.0	79.8	2.9	6.5	0.0	0.0	0.0	0.0	-0.0	-18.0	-18.0
5	499998.21	5441505.21	2.58	0	500	76.5	76.5	0.0	0.0	79.8	5.3	2.2	0.0	0.0	0.0	0.0	-0.0	-10.7	-10.7
6	499998.21	5441505.21	2.58	0	1000	73.7	73.7	0.0	0.0	79.8	10.0	-1.3	0.0	0.0	0.0	0.0	-0.0	-14.8	-14.8
7	499998.21	5441505.21	2.58	0	2000	69.9	69.9	0.0	0.0	79.8	26.5	-1.8	0.0	0.0	0.0	0.0	-0.0	-34.6	-34.6
8	499998.21	5441505.21	2.58	0	4000	64.7	64.7	0.0	0.0	79.8	89.9	-1.8	0.0	0.0	0.0	0.0	-0.0	-103.2	-103.2
9	499998.21	5441505.21	2.58	0	8000	55.6	55.6	0.0	0.0	79.8	320.5	-1.8	0.0	0.0	0.0	0.0	-0.0	-342.9	-342.9

Point Source, ISO 9613, Name: "MM_Sub115", ID: "MM_Sub115"																			
Nr.	X	Y	Z	Refl.	Freq.	LxT	LxN	K0	Dc	Adiv	Aatm	Agr	Afol	Ahous	Abar	Cmet	RL	LrT	LrN
	(m)	(m)	(m)		(Hz)	dB(A)	dB(A)	(dB)	(dB)	(dB)	(dB)	(dB)	(dB)	(dB)	(dB)	(dB)	(dB)	dB(A)	dB(A)
1	500993.61	5443521.27	3.60	0	32	43.3	43.3	0.0	0.0	69.3	0.0	-5.4	0.0	0.0	0.0	0.0	-0.0	-20.6	-20.6
2	500993.61	5443521.27	3.60	0	63	60.5	60.5	0.0	0.0	69.3	0.1	-5.4	0.0	0.0	0.0	0.0	-0.0	-3.4	-3.4
3	500993.61	5443521.27	3.60	0	125	73.6	73.6	0.0	0.0	69.3	0.3	4.3	0.0	0.0	0.0	0.0	-0.0	-0.4	-0.4
4	500993.61	5443521.27	3.60	0	250	79.1	79.1	0.0	0.0	69.3	0.9	5.2	0.0	0.0	0.0	0.0	-0.0	3.8	3.8
5	500993.61	5443521.27	3.60	0	500	84.5	84.5	0.0	0.0	69.3	1.6	1.9	0.0	0.0	0.0	0.0	-0.0	11.8	11.8
6	500993.61	5443521.27	3.60	0	1000	81.7	81.7	0.0	0.0	69.3	3.0	-1.2	0.0	0.0	0.0	0.0	-0.0	10.6	10.6
7	500993.61	5443521.27	3.60	0	2000	77.9	77.9	0.0	0.0	69.3	7.9	-1.6	0.0	0.0	0.0	0.0	-0.0	2.3	2.3
8	500993.61	5443521.27	3.60	0	4000	72.7	72.7	0.0	0.0	69.3	26.9	-1.6	0.0	0.0	0.0	0.0	-0.0	-21.9	-21.9
9	500993.61	5443521.27	3.60	0	8000	62.6	62.6	0.0	0.0	69.3	96.0	-1.6	0.0	0.0	0.0	0.0	-0.0	-101.1	-101.1

Point Source, ISO 9613, Name: "MM_Inv1", ID: "MM_Inv1"																			
Nr.	X	Y	Z	Refl.	Freq.	LxT	LxN	K0	Dc	Adiv	Aatm	Agr	Afol	Ahous	Abar	Cmet	RL	LrT	LrN
	(m)	(m)	(m)		(Hz)	dB(A)	dB(A)	(dB)	(dB)	(dB)	(dB)	(dB)	(dB)	(dB)	(dB)	(dB)	(dB)	dB(A)	dB(A)
1	501222.00	5443157.66	2.60	0	63	68.1	68.1	0.0	0.0	68.1	0.1	-5.5	0.0	0.0	0.0	0.0	-0.0	5.4	5.4
2	501222.00	5443157.66	2.60	0	125	78.9	78.9	0.0	0.0	68.1	0.3	4.0	0.0	0.0	0.0	0.0	-0.0	6.5	6.5
3	501222.00	5443157.66	2.60	0	250	85.5	85.5	0.0	0.0	68.1	0.8	6.5	0.0	0.0	0.0	0.0	-0.0	10.1	10.1
4	501222.00	5443157.66	2.60	0	500	87.3	87.3	0.0	0.0	68.1	1.4	2.3	0.0	0.0	0.0	0.0	-0.0	15.6	15.6
5	501222.00	5443157.66	2.60	0	1000	83.7	83.7	0.0	0.0	68.1	2.6	-1.2	0.0	0.0	0.0	0.0	-0.0	14.2	14.2
6	501222.00	5443157.66	2.60	0	2000	79.1	79.1	0.0	0.0	68.1	6.9	-1.7	0.0	0.0	0.0	0.0	-0.0	5.7	5.7
7	501222.00	5443157.66	2.60	0	4000	70.0	70.0	0.0	0.0	68.1	23.5	-1.7	0.0	0.0	0.0	0.0	-0.0	-19.9	-19.9
8	501222.00	5443157.66	2.60	0	8000	77.7	77.7	0.0	0.0	68.1	83.7	-1.7	0.0	0.0	0.0	0.0	-0.0	-72.5	-72.5

Point Source, ISO 9613, Name: "MM_Inv2", ID: "MM_Inv2"																			
Nr.	X	Y	Z	Refl.	Freq.	LxT	LxN	K0	Dc	Adiv	Aatm	Agr	Afol	Ahous	Abar	Cmet	RL	LrT	LrN
	(m)	(m)	(m)		(Hz)	dB(A)	dB(A)	(dB)	(dB)	(dB)	(dB)	(dB)	(dB)	(dB)	(dB)	(dB)	(dB)	dB(A)	dB(A)
1	501240.10	5442978.46	2.60	0	63	68.1	68.1	0.0	0.0	69.3	0.1	-5.5	0.0	0.0	0.0	0.0	-0.0	4.3	4.3
2	501240.10	5442978.46	2.60	0	125	78.9	78.9	0.0	0.0	69.3	0.3	4.5	0.0	0.0	0.0	0.0	-0.0	4.8	4.8
3	501240.10	5442978.46	2.60	0	250	85.5	85.5	0.0	0.0	69.3	0.9	6.5	0.0	0.0	0.0	0.0	-0.0	8.9	8.9
4	501240.10	5442978.46	2.60	0	500	87.3	87.3	0.0	0.0	69.3	1.6	2.3	0.0	0.0	0.0	0.0	-0.0	14.2	14.2
5	501240.10	5442978.46	2.60	0	1000	83.7	83.7	0.0	0.0	69.3	3.0	-1.2	0.0	0.0	0.0	0.0	-0.0	12.7	12.7
6	501240.10	5442978.46	2.60	0	2000	79.1	79.1	0.0	0.0	69.3	7.9	-1.7	0.0	0.0	0.0	0.0	-0.0	3.6	3.6
7	501240.10	5442978.46	2.60	0	4000	70.0	70.0	0.0	0.0	69.3	26.8	-1.7	0.0	0.0	0.0	0.0	-0.0	-24.4	-24.4
8	501240.10	5442978.46	2.60	0	8000	77.7	77.7	0.0	0.0	69.3	95.5	-1.7	0.0	0.0	0.0	0.0	-0.0	-85.4	-85.4

Point Source, ISO 9613, Name: "MM_Inv3", ID: "MM_Inv3"																			
Nr.	X	Y	Z	Refl.	Freq.	LxT	LxN	K0	Dc	Adiv	Aatm	Agr	Afol	Ahous	Abar	Cmet	RL	LrT	LrN
	(m)	(m)	(m)		(Hz)	dB(A)	dB(A)	(dB)	(dB)	(dB)	(dB)	(dB)	(dB)	(dB)	(dB)	(dB)	(dB)	dB(A)	dB(A)
1	501240.10	5442776.86	2.60	0	63	68.1	68.1	0.0	0.0	70.8	0.1	-5.6	0.0	0.0	0.0	0.0	-0.0	2.9	2.9
2	501240.10	5442776.86	2.60	0	125	78.9	78.9	0.0	0.0	70.8	0.4	4.9	0.0	0.0	0.0	0.0	-0.0	2.9	2.9
3	501240.10	5442776.86	2.60	0	250	85.5	85.5	0.0	0.0	70.8	1.0	6.5	0.0	0.0	0.0	0.0	-0.0	7.2	7.2
4	501240.10	5442776.86	2.60	0	500	87.3	87.3	0.0	0.0	70.8	1.9	2.2	0.0	0.0	0.0	0.0	-0.0	12.5	12.5
5	501240.10	5442776.86	2.60	0	1000	83.7	83.7	0.0	0.0	70.8	3.5	-1.2	0.0	0.0	0.0	0.0	-0.0	10.6	10.6
6	501240.10	5442776.86	2.60	0	2000	79.1	79.1	0.0	0.0	70.8	9.4	-1.7	0.0	0.0	0.0	0.0	-0.0	0.7	0.7
7	501240.10	5442776.86	2.60	0	4000	70.0	70.0	0.0	0.0	70.8	31.8	-1.7	0.0	0.0	0.0	0.0	-0.0	-30.9	-30.9
8	501240.10	5442776.86	2.60	0	8000	77.7	77.7	0.0	0.0	70.8	113.5	-1.7	0.0	0.0	0.0	0.0	-0.0	-104.9	-104.9

Point Source, ISO 9613, Name: "MM_Inv4", ID: "MM_Inv4"																			
Nr.	X	Y	Z	Refl.	Freq.	LxT	LxN	K0	Dc	Adiv	Aatm	Agr	Afol	Ahous	Abar	Cmet	RL	LrT	LrN
	(m)	(m)	(m)		(Hz)	dB(A)	dB(A)	(dB)	(dB)	(dB)	(dB)	(dB)	(dB)	(dB)	(dB)	(dB)	(dB)	dB(A)	dB(A)
1	501240.10	5442575.26	2.60	0	63	68.1	68.1	0.0	0.0	72.1	0.1	-5.7	0.0	0.0	0.0	0.0	-0.0	1.5	1.5
2	501240.10	5442575.26	2.60	0	125	78.9	78.9	0.0	0.0	72.1	0.5	5.1	0.0	0.0	0.0	0.0	-0.0	1.2	1.2
3	501240.10	5442575.26	2.60	0	250	85.5	85.5	0.0	0.0	72.1	1.2	6.5	0.0	0.0	0.0	0.0	-0.0	5.7	5.7
4	501240.10	5442575.26	2.60	0	500	87.3	87.3	0.0	0.0	72.1	2.2	2.2	0.0	0.0	0.0	0.0	-0.0	10.8	10.8
5	501240.10	5442575.26	2.60	0	1000	83.7	83.7	0.0	0.0	72.1	4.2	-1.2	0.0	0.0	0.0	0.0	-0.0	8.6	8.6
6	501240.10	5442575.26	2.60	0	2000	79.1	79.1	0.0	0.0	72.1	11.0	-1.7	0.0	0.0	0.0	0.0	-0.0	-2.3	-2.3
7	501240.10	5442575.26	2.60	0	4000	70.0	70.0	0.0	0.0	72.1	37.4	-1.7	0.0	0.0	0.0	0.0	-0.0	-37.8	-37.8
8	501240.10	5442575.26	2.60	0	8000	77.7	77.7	0.0	0.0	72.1	133.3	-1.7	0.0	0.0	0.0	0.0	-0.0	-126.0	-126.0

Point Source, ISO 9613, Name: "MM_Inv5", ID: "MM_Inv5"																			
Nr.	X	Y	Z	Refl.	Freq.	LxT	LxN	K0	Dc	Adiv	Aatm	Agr	Afol	Ahous	Abar	Cmet	RL	LrT	LrN
	(m)	(m)	(m)		(Hz)	dB(A)	dB(A)	(dB)	(dB)	(dB)	(dB)	(dB)	(dB)	(dB)	(dB)	(dB)	(dB)	dB(A)	dB(A)
1	500977.67	5442553.91	2.60	0	63	68.1	68.1	0.0	0.0	73.3	0.2	-5.7	0.0	0.0	0.0	0.0	-0.0	0.3	0.3
2	500977.67	5442553.91	2.60	0	125	78.9	78.9	0.0	0.0	73.3	0.5	5.2	0.0	0.0	0.0	0.0	-0.0	-0.2	-0.2
3	500977.67	5442553.91	2.60	0	250	85.5	85.5	0.0	0.0	73.3	1.4	6.5	0.0	0.0	0.0	0.0	-0.0	4.3	4.3
4	500977.67	5442553.91	2.60	0	500	87.3	87.3	0.0	0.0	73.3	2.5	2.2	0.0	0.0	0.0	0.0	-0.0	9.2	9.2
5	500977.67	5442553.91	2.60	0	1000	83.7	83.7	0.0	0.0	73.3	4.8	-1.3	0.0	0.0	0.0	0.0	-0.0	6.8	6.8
6	500977.67	5442553.91	2.60	0	2000	79.1	79.1	0.0	0.0	73.3	12.7	-1.7	0.0	0.0	0.0	0.0	-0.0	-5.2	-5.2
7	500977.67	5442553.91	2.60	0	4000	70.0	70.0	0.0	0.0	73.3	42.9	-1.7	0.0	0.0	0.0	0.0	-0.0	-44.5	-44.5
8	500977.67	5442553.91	2.60	0	8000	77.7	77.7	0.0	0.0	73.3	153.0	-1.7	0.0	0.0	0.0	0.0	-0.0	-146.9	-146.9

Point Source, ISO 9613, Name: "MM_Inv6", ID: "MM_Inv6"																			
Nr.	X	Y	Z	Refl.	Freq.	LxT	LxN	K0	Dc	Adiv	Aatm	Agr	Afol	Ahous	Abar	Cmet	RL	LrT	LrN
	(m)	(m)	(m)		(Hz)	dB(A)	dB(A)	(dB)	(dB)	(dB)	(dB)	(dB)	(dB)	(dB)	(dB)	(dB)	(dB)	dB(A)	dB(A)
1	500977.67	5442755.51	2.60	0	63	68.1	68.1	0.0	0.0	72.3	0.1	-5.7	0.0	0.0	0.0	0.0	-0.0	1.4	1.4
2	500977.67	5442755.51	2.60	0	125	78.9	78.9	0.0	0.0	72.3	0.5	5.1	0.0	0.0	0.0	0.0	-0.0	1.0	1.0
3	500977.67	5442755.51	2.60	0	250	85.5	85.5	0.0	0.0	72.3	1.2	6.5	0.0	0.0	0.0	0.0	-0.0	5.5	5.5
4	500977.67	5442755.51	2.60	0	500	87.3	87.3	0.0	0.0	72.3	2.2	2.2	0.0	0.0	0.0	0.0	-0.0	10.6	10.6
5	500977.67	5442755.51	2.60	0	1000	83.7	83.7	0.0	0.0	72.3	4.3	-1.2	0.0	0.0	0.0	0.0	-0.0	8.4	8.4
6	500977.67	5442755.51	2.60	0	2000	79.1	79.1	0.0	0.0	72.3	11.2	-1.7	0.0	0.0	0.0	0.0	-0.0	-2.7	-2.7
7	500977.67	5442755.51	2.60	0	4000	70.0	70.0	0.0	0.0	72.3	38.0	-1.7	0.0	0.0	0.0	0.0	-0.0	-38.6	-38.6
8	500977.67	5442755.51	2.60	0	8000	77.7	77.7	0.0	0.0	72.3	135.7	-1.7	0.0	0.0	0.0	0.0	-0.0	-128.6	-128.6

Point Source, ISO 9613, Name: "MM_Inv7", ID: "MM_Inv7"																			
Nr.	X	Y	Z	Refl.	Freq.	LxT	LxN	K0	Dc	Adiv	Aatm	Agr	Afol	Ahous	Abar	Cmet	RL	LrT	LrN
	(m)	(m)	(m)		(Hz)	dB(A)	dB(A)	(dB)	(dB)	(dB)	(dB)	(dB)	(dB)	(dB)	(dB)	(dB)	(dB)	dB(A)	dB(A)
1	500977.67	5442957.06	2.60	0	63	68.1	68.1	0.0	0.0	71.3	0.1	-5.6	0.0	0.0	0.0	0.0	-0.0	2.3	2.3
2	500977.67	5442957.06	2.60	0	125	78.9	78.9	0.0	0.0	71.3	0.4	5.0	0.0	0.0	0.0	0.0	-0.0	2.2	2.2
3	500977.67	5442957.06	2.60	0	250	85.5	85.5	0.0	0.0	71.3	1.1	6.5	0.0	0.0	0.0	0.0	-0.0	6.7	6.7

Point Source, ISO 9613, Name: "MM_Inv7", ID: "MM_Inv7"																			
Nr.	X	Y	Z	Refl.	Freq.	LxT	LxN	K0	Dc	Adiv	Aatm	Agr	Afol	Ahous	Abar	Cmet	RL	LrT	LrN
	(m)	(m)	(m)		(Hz)	dB(A)	dB(A)	(dB)	(dB)	(dB)	(dB)	(dB)	(dB)	(dB)	(dB)	(dB)	(dB)	dB(A)	dB(A)
4	500977.67	5442957.06	2.60	0	500	87.3	87.3	0.0	0.0	71.3	2.0	2.2	0.0	0.0	0.0	0.0	-0.0	11.8	11.8
5	500977.67	5442957.06	2.60	0	1000	83.7	83.7	0.0	0.0	71.3	3.8	-1.2	0.0	0.0	0.0	0.0	-0.0	9.9	9.9
6	500977.67	5442957.06	2.60	0	2000	79.1	79.1	0.0	0.0	71.3	10.0	-1.7	0.0	0.0	0.0	0.0	-0.0	-0.4	-0.4
7	500977.67	5442957.06	2.60	0	4000	70.0	70.0	0.0	0.0	71.3	33.8	-1.7	0.0	0.0	0.0	0.0	-0.0	-33.4	-33.4
8	500977.67	5442957.06	2.60	0	8000	77.7	77.7	0.0	0.0	71.3	120.6	-1.7	0.0	0.0	0.0	0.0	-0.0	-112.4	-112.4

Point Source, ISO 9613, Name: "MM_Trans1", ID: "MM_Trans1"																			
Nr.	X	Y	Z	Refl.	Freq.	LxT	LxN	K0	Dc	Adiv	Aatm	Agr	Afol	Ahous	Abar	Cmet	RL	LrT	LrN
	(m)	(m)	(m)		(Hz)	dB(A)	dB(A)	(dB)	(dB)	(dB)	(dB)	(dB)	(dB)	(dB)	(dB)	(dB)	(dB)	dB(A)	dB(A)
1	501216.50	5443158.16	2.58	0	32	37.3	37.3	0.0	0.0	68.1	0.0	-5.5	0.0	0.0	0.0	0.0	-0.0	-25.4	-25.4
2	501216.50	5443158.16	2.58	0	63	56.5	56.5	0.0	0.0	68.1	0.1	-5.5	0.0	0.0	0.0	0.0	-0.0	-6.3	-6.3
3	501216.50	5443158.16	2.58	0	125	68.6	68.6	0.0	0.0	68.1	0.3	4.0	0.0	0.0	0.0	0.0	-0.0	-3.9	-3.9
4	501216.50	5443158.16	2.58	0	250	71.1	71.1	0.0	0.0	68.1	0.8	6.6	0.0	0.0	0.0	0.0	-0.0	-4.4	-4.4
5	501216.50	5443158.16	2.58	0	500	76.5	76.5	0.0	0.0	68.1	1.4	2.3	0.0	0.0	0.0	0.0	-0.0	4.7	4.7
6	501216.50	5443158.16	2.58	0	1000	73.7	73.7	0.0	0.0	68.1	2.6	-1.2	0.0	0.0	0.0	0.0	-0.0	4.1	4.1
7	501216.50	5443158.16	2.58	0	2000	69.9	69.9	0.0	0.0	68.1	7.0	-1.7	0.0	0.0	0.0	0.0	-0.0	-3.6	-3.6
8	501216.50	5443158.16	2.58	0	4000	64.7	64.7	0.0	0.0	68.1	23.6	-1.7	0.0	0.0	0.0	0.0	-0.0	-25.4	-25.4
9	501216.50	5443158.16	2.58	0	8000	55.6	55.6	0.0	0.0	68.1	84.2	-1.7	0.0	0.0	0.0	0.0	-0.0	-95.1	-95.1

Point Source, ISO 9613, Name: "MM_Trans2", ID: "MM_Trans2"																			
Nr.	X	Y	Z	Refl.	Freq.	LxT	LxN	K0	Dc	Adiv	Aatm	Agr	Afol	Ahous	Abar	Cmet	RL	LrT	LrN
	(m)	(m)	(m)		(Hz)	dB(A)	dB(A)	(dB)	(dB)	(dB)	(dB)	(dB)	(dB)	(dB)	(dB)	(dB)	(dB)	dB(A)	dB(A)
1	501234.60	5442978.96	2.58	0	32	37.3	37.3	0.0	0.0	69.3	0.0	-5.5	0.0	0.0	0.0	0.0	-0.0	-26.5	-26.5
2	501234.60	5442978.96	2.58	0	63	56.5	56.5	0.0	0.0	69.3	0.1	-5.5	0.0	0.0	0.0	0.0	-0.0	-7.3	-7.3
3	501234.60	5442978.96	2.58	0	125	68.6	68.6	0.0	0.0	69.3	0.3	4.5	0.0	0.0	0.0	0.0	-0.0	-5.5	-5.5
4	501234.60	5442978.96	2.58	0	250	71.1	71.1	0.0	0.0	69.3	0.9	6.6	0.0	0.0	0.0	0.0	-0.0	-5.6	-5.6
5	501234.60	5442978.96	2.58	0	500	76.5	76.5	0.0	0.0	69.3	1.6	2.3	0.0	0.0	0.0	0.0	-0.0	3.4	3.4
6	501234.60	5442978.96	2.58	0	1000	73.7	73.7	0.0	0.0	69.3	3.0	-1.2	0.0	0.0	0.0	0.0	-0.0	2.6	2.6
7	501234.60	5442978.96	2.58	0	2000	69.9	69.9	0.0	0.0	69.3	7.9	-1.7	0.0	0.0	0.0	0.0	-0.0	-5.6	-5.6
8	501234.60	5442978.96	2.58	0	4000	64.7	64.7	0.0	0.0	69.3	26.9	-1.7	0.0	0.0	0.0	0.0	-0.0	-29.8	-29.8
9	501234.60	5442978.96	2.58	0	8000	55.6	55.6	0.0	0.0	69.3	95.9	-1.7	0.0	0.0	0.0	0.0	-0.0	-108.0	-108.0

Point Source, ISO 9613, Name: "MM_Trans3", ID: "MM_Trans3"																			
Nr.	X	Y	Z	Refl.	Freq.	LxT	LxN	K0	Dc	Adiv	Aatm	Agr	Afol	Ahous	Abar	Cmet	RL	LrT	LrN
	(m)	(m)	(m)		(Hz)	dB(A)	dB(A)	(dB)	(dB)	(dB)	(dB)	(dB)	(dB)	(dB)	(dB)	(dB)	(dB)	dB(A)	dB(A)
1	501234.60	5442777.36	2.58	0	32	37.3	37.3	0.0	0.0	70.8	0.0	-5.6	0.0	0.0	0.0	0.0	-0.0	-27.9	-27.9
2	501234.60	5442777.36	2.58	0	63	56.5	56.5	0.0	0.0	70.8	0.1	-5.6	0.0	0.0	0.0	0.0	-0.0	-8.8	-8.8
3	501234.60	5442777.36	2.58	0	125	68.6	68.6	0.0	0.0	70.8	0.4	4.9	0.0	0.0	0.0	0.0	-0.0	-7.5	-7.5
4	501234.60	5442777.36	2.58	0	250	71.1	71.1	0.0	0.0	70.8	1.0	6.5	0.0	0.0	0.0	0.0	-0.0	-7.2	-7.2
5	501234.60	5442777.36	2.58	0	500	76.5	76.5	0.0	0.0	70.8	1.9	2.3	0.0	0.0	0.0	0.0	-0.0	1.6	1.6
6	501234.60	5442777.36	2.58	0	1000	73.7	73.7	0.0	0.0	70.8	3.6	-1.2	0.0	0.0	0.0	0.0	-0.0	0.6	0.6
7	501234.60	5442777.36	2.58	0	2000	69.9	69.9	0.0	0.0	70.8	9.4	-1.7	0.0	0.0	0.0	0.0	-0.0	-8.6	-8.6
8	501234.60	5442777.36	2.58	0	4000	64.7	64.7	0.0	0.0	70.8	31.9	-1.7	0.0	0.0	0.0	0.0	-0.0	-36.3	-36.3
9	501234.60	5442777.36	2.58	0	8000	55.6	55.6	0.0	0.0	70.8	113.8	-1.7	0.0	0.0	0.0	0.0	-0.0	-127.3	-127.3

Point Source, ISO 9613, Name: "MM_Trans4", ID: "MM_Trans4"																			
Nr.	X	Y	Z	Refl.	Freq.	LxT	LxN	K0	Dc	Adiv	Aatm	Agr	Afol	Ahous	Abar	Cmet	RL	LrT	LrN
	(m)	(m)	(m)		(Hz)	dB(A)	dB(A)	(dB)	(dB)	(dB)	(dB)	(dB)	(dB)	(dB)	(dB)	(dB)	(dB)	dB(A)	dB(A)
1	501234.60	5442575.76	2.58	0	32	37.3	37.3	0.0	0.0	72.2	0.0	-5.7	0.0	0.0	0.0	0.0	-0.0	-29.2	-29.2
2	501234.60	5442575.76	2.58	0	63	56.5	56.5	0.0	0.0	72.2	0.1	-5.7	0.0	0.0	0.0	0.0	-0.0	-10.1	-10.1
3	501234.60	5442575.76	2.58	0	125	68.6	68.6	0.0	0.0	72.2	0.5	5.1	0.0	0.0	0.0	0.0	-0.0	-9.2	-9.2
4	501234.60	5442575.76	2.58	0	250	71.1	71.1	0.0	0.0	72.2	1.2	6.5	0.0	0.0	0.0	0.0	-0.0	-8.8	-8.8
5	501234.60	5442575.76	2.58	0	500	76.5	76.5	0.0	0.0	72.2	2.2	2.2	0.0	0.0	0.0	0.0	-0.0	-0.1	-0.1
6	501234.60	5442575.76	2.58	0	1000	73.7	73.7	0.0	0.0	72.2	4.2	-1.2	0.0	0.0	0.0	0.0	-0.0	-1.4	-1.4
7	501234.60	5442575.76	2.58	0	2000	69.9	69.9	0.0	0.0	72.2	11.0	-1.7	0.0	0.0	0.0	0.0	-0.0	-11.6	-11.6
8	501234.60	5442575.76	2.58	0	4000	64.7	64.7	0.0	0.0	72.2	37.4	-1.7	0.0	0.0	0.0	0.0	-0.0	-43.2	-43.2
9	501234.60	5442575.76	2.58	0	8000	55.6	55.6	0.0	0.0	72.2	133.5	-1.7	0.0	0.0	0.0	0.0	-0.0	-148.4	-148.4

Point Source, ISO 9613, Name: "MM_Trans5", ID: "MM_Trans5"																			
Nr.	X	Y	Z	Refl.	Freq.	LxT	LxN	K0	Dc	Adiv	Aatm	Agr	Afol	Ahous	Abar	Cmet	RL	LrT	LrN
	(m)	(m)	(m)		(Hz)	dB(A)	dB(A)	(dB)	(dB)	(dB)	(dB)	(dB)	(dB)	(dB)	(dB)	(dB)	(dB)	dB(A)	dB(A)
1	500983.17	5442553.41	2.58	0	32	37.3	37.3	0.0	0.0	73.3	0.0	-5.7	0.0	0.0	0.0	0.0	-0.0	-30.3	-30.3
2	500983.17	5442553.41	2.58	0	63	56.5	56.5	0.0	0.0	73.3	0.2	-5.7	0.0	0.0	0.0	0.0	-0.0	-11.3	-11.3

Point Source, ISO 9613, Name: "MM_Trans5", ID: "MM_Trans5"																			
Nr.	X	Y	Z	Refl.	Freq.	LxT	LxN	K0	Dc	Adiv	Aatm	Agr	Afol	Ahaus	Abar	Cmet	RL	LrT	LrN
	(m)	(m)	(m)		(Hz)	dB(A)	dB(A)	(dB)	(dB)	(dB)	(dB)	(dB)	(dB)	(dB)	(dB)	(dB)	(dB)	dB(A)	dB(A)
3	500983.17	5442553.41	2.58	0	125	68.6	68.6	0.0	0.0	73.3	0.5	5.2	0.0	0.0	0.0	0.0	-0.0	-10.5	-10.5
4	500983.17	5442553.41	2.58	0	250	71.1	71.1	0.0	0.0	73.3	1.4	6.5	0.0	0.0	0.0	0.0	-0.0	-10.1	-10.1
5	500983.17	5442553.41	2.58	0	500	76.5	76.5	0.0	0.0	73.3	2.5	2.2	0.0	0.0	0.0	0.0	-0.0	-1.6	-1.6
6	500983.17	5442553.41	2.58	0	1000	73.7	73.7	0.0	0.0	73.3	4.8	-1.2	0.0	0.0	0.0	0.0	-0.0	-3.1	-3.1
7	500983.17	5442553.41	2.58	0	2000	69.9	69.9	0.0	0.0	73.3	12.6	-1.7	0.0	0.0	0.0	0.0	-0.0	-14.3	-14.3
8	500983.17	5442553.41	2.58	0	4000	64.7	64.7	0.0	0.0	73.3	42.8	-1.7	0.0	0.0	0.0	0.0	-0.0	-49.7	-49.7
9	500983.17	5442553.41	2.58	0	8000	55.6	55.6	0.0	0.0	73.3	152.6	-1.7	0.0	0.0	0.0	0.0	-0.0	-168.6	-168.6

Point Source, ISO 9613, Name: "MM_Trans6", ID: "MM_Trans6"																			
Nr.	X	Y	Z	Refl.	Freq.	LxT	LxN	K0	Dc	Adiv	Aatm	Agr	Afol	Ahaus	Abar	Cmet	RL	LrT	LrN
	(m)	(m)	(m)		(Hz)	dB(A)	dB(A)	(dB)	(dB)	(dB)	(dB)	(dB)	(dB)	(dB)	(dB)	(dB)	(dB)	dB(A)	dB(A)
1	500983.17	5442755.01	2.58	0	32	37.3	37.3	0.0	0.0	72.3	0.0	-5.7	0.0	0.0	0.0	0.0	-0.0	-29.3	-29.3
2	500983.17	5442755.01	2.58	0	63	56.5	56.5	0.0	0.0	72.3	0.1	-5.7	0.0	0.0	0.0	0.0	-0.0	-10.2	-10.2
3	500983.17	5442755.01	2.58	0	125	68.6	68.6	0.0	0.0	72.3	0.5	5.1	0.0	0.0	0.0	0.0	-0.0	-9.3	-9.3
4	500983.17	5442755.01	2.58	0	250	71.1	71.1	0.0	0.0	72.3	1.2	6.5	0.0	0.0	0.0	0.0	-0.0	-8.9	-8.9
5	500983.17	5442755.01	2.58	0	500	76.5	76.5	0.0	0.0	72.3	2.2	2.2	0.0	0.0	0.0	0.0	-0.0	-0.2	-0.2
6	500983.17	5442755.01	2.58	0	1000	73.7	73.7	0.0	0.0	72.3	4.2	-1.2	0.0	0.0	0.0	0.0	-0.0	-1.6	-1.6
7	500983.17	5442755.01	2.58	0	2000	69.9	69.9	0.0	0.0	72.3	11.2	-1.7	0.0	0.0	0.0	0.0	-0.0	-11.9	-11.9
8	500983.17	5442755.01	2.58	0	4000	64.7	64.7	0.0	0.0	72.3	37.9	-1.7	0.0	0.0	0.0	0.0	-0.0	-43.8	-43.8
9	500983.17	5442755.01	2.58	0	8000	55.6	55.6	0.0	0.0	72.3	135.3	-1.7	0.0	0.0	0.0	0.0	-0.0	-150.2	-150.2

Point Source, ISO 9613, Name: "MM_Trans7", ID: "MM_Trans7"																			
Nr.	X	Y	Z	Refl.	Freq.	LxT	LxN	K0	Dc	Adiv	Aatm	Agr	Afol	Ahaus	Abar	Cmet	RL	LrT	LrN
	(m)	(m)	(m)		(Hz)	dB(A)	dB(A)	(dB)	(dB)	(dB)	(dB)	(dB)	(dB)	(dB)	(dB)	(dB)	(dB)	dB(A)	dB(A)
1	500983.17	5442956.56	2.58	0	32	37.3	37.3	0.0	0.0	71.2	0.0	-5.6	0.0	0.0	0.0	0.0	-0.0	-28.3	-28.3
2	500983.17	5442956.56	2.58	0	63	56.5	56.5	0.0	0.0	71.2	0.1	-5.6	0.0	0.0	0.0	0.0	-0.0	-9.2	-9.2
3	500983.17	5442956.56	2.58	0	125	68.6	68.6	0.0	0.0	71.2	0.4	5.0	0.0	0.0	0.0	0.0	-0.0	-8.1	-8.1
4	500983.17	5442956.56	2.58	0	250	71.1	71.1	0.0	0.0	71.2	1.1	6.5	0.0	0.0	0.0	0.0	-0.0	-7.7	-7.7
5	500983.17	5442956.56	2.58	0	500	76.5	76.5	0.0	0.0	71.2	2.0	2.3	0.0	0.0	0.0	0.0	-0.0	1.0	1.0
6	500983.17	5442956.56	2.58	0	1000	73.7	73.7	0.0	0.0	71.2	3.8	-1.2	0.0	0.0	0.0	0.0	-0.0	-0.1	-0.1
7	500983.17	5442956.56	2.58	0	2000	69.9	69.9	0.0	0.0	71.2	9.9	-1.7	0.0	0.0	0.0	0.0	-0.0	-9.6	-9.6
8	500983.17	5442956.56	2.58	0	4000	64.7	64.7	0.0	0.0	71.2	33.7	-1.7	0.0	0.0	0.0	0.0	-0.0	-38.5	-38.5
9	500983.17	5442956.56	2.58	0	8000	55.6	55.6	0.0	0.0	71.2	120.1	-1.7	0.0	0.0	0.0	0.0	-0.0	-134.0	-134.0

Receiver

Name: 15_R47

ID: 15_R47

X: 502186.73

Y: 5443660.67

Z: 1.50

Point Source, ISO 9613, Name: "Ab_Sub115", ID: "Ab_Sub115"

Nr.	X (m)	Y (m)	Z (m)	Refl.	Freq. (Hz)	LxT dB(A)	LxN dB(A)	K0 (dB)	Dc (dB)	Adiv (dB)	Aatm (dB)	Agr (dB)	Afol (dB)	Ahous (dB)	Abar (dB)	Cmet (dB)	RL (dB)	LrT dB(A)	LrN dB(A)
1	501008.63	5443536.29	3.60	0	32	43.3	43.3	0.0	0.0	72.5	0.0	-5.6	0.0	0.0	0.0	0.0	-0.0	-23.6	-23.6
2	501008.63	5443536.29	3.60	0	63	60.5	60.5	0.0	0.0	72.5	0.1	-5.6	0.0	0.0	0.0	0.0	-0.0	-6.5	-6.5
3	501008.63	5443536.29	3.60	0	125	73.6	73.6	0.0	0.0	72.5	0.5	4.9	0.0	0.0	0.0	0.0	-0.0	-4.2	-4.2
4	501008.63	5443536.29	3.60	0	250	79.1	79.1	0.0	0.0	72.5	1.2	5.1	0.0	0.0	0.0	0.0	-0.0	0.3	0.3
5	501008.63	5443536.29	3.60	0	500	84.5	84.5	0.0	0.0	72.5	2.3	1.8	0.0	0.0	0.0	0.0	-0.0	7.9	7.9
6	501008.63	5443536.29	3.60	0	1000	81.7	81.7	0.0	0.0	72.5	4.3	-1.2	0.0	0.0	0.0	0.0	-0.0	6.1	6.1
7	501008.63	5443536.29	3.60	0	2000	77.9	77.9	0.0	0.0	72.5	11.5	-1.7	0.0	0.0	0.0	0.0	-0.0	-4.3	-4.3
8	501008.63	5443536.29	3.60	0	4000	72.7	72.7	0.0	0.0	72.5	38.8	-1.7	0.0	0.0	0.0	0.0	-0.0	-36.9	-36.9
9	501008.63	5443536.29	3.60	0	8000	62.6	62.6	0.0	0.0	72.5	138.5	-1.7	0.0	0.0	0.0	0.0	-0.0	-146.7	-146.7

Point Source, ISO 9613, Name: "Ab_Inv1", ID: "Ab_Inv1"

Nr.	X (m)	Y (m)	Z (m)	Refl.	Freq. (Hz)	LxT dB(A)	LxN dB(A)	K0 (dB)	Dc (dB)	Adiv (dB)	Aatm (dB)	Agr (dB)	Afol (dB)	Ahous (dB)	Abar (dB)	Cmet (dB)	RL (dB)	LrT dB(A)	LrN dB(A)
1	501813.68	5442663.24	2.60	0	63	68.1	68.1	0.0	0.0	71.5	0.1	-5.6	0.0	0.0	0.0	0.0	-0.0	2.1	2.1
2	501813.68	5442663.24	2.60	0	125	78.9	78.9	0.0	0.0	71.5	0.4	5.0	0.0	0.0	0.0	0.0	-0.0	1.9	1.9
3	501813.68	5442663.24	2.60	0	250	85.5	85.5	0.0	0.0	71.5	1.1	6.5	0.0	0.0	0.0	0.0	-0.0	6.3	6.3
4	501813.68	5442663.24	2.60	0	500	87.3	87.3	0.0	0.0	71.5	2.0	2.2	0.0	0.0	0.0	0.0	-0.0	11.5	11.5
5	501813.68	5442663.24	2.60	0	1000	83.7	83.7	0.0	0.0	71.5	3.9	-1.2	0.0	0.0	0.0	0.0	-0.0	9.5	9.5
6	501813.68	5442663.24	2.60	0	2000	79.1	79.1	0.0	0.0	71.5	10.3	-1.7	0.0	0.0	0.0	0.0	-0.0	-1.0	-1.0
7	501813.68	5442663.24	2.60	0	4000	70.0	70.0	0.0	0.0	71.5	34.9	-1.7	0.0	0.0	0.0	0.0	-0.0	-34.8	-34.8
8	501813.68	5442663.24	2.60	0	8000	77.7	77.7	0.0	0.0	71.5	124.5	-1.7	0.0	0.0	0.0	0.0	-0.0	-116.6	-116.6

Point Source, ISO 9613, Name: "Ab_Inv2", ID: "Ab_Inv2"

Nr.	X (m)	Y (m)	Z (m)	Refl.	Freq. (Hz)	LxT dB(A)	LxN dB(A)	K0 (dB)	Dc (dB)	Adiv (dB)	Aatm (dB)	Agr (dB)	Afol (dB)	Ahous (dB)	Abar (dB)	Cmet (dB)	RL (dB)	LrT dB(A)	LrN dB(A)
1	501813.68	5442842.44	2.60	0	63	68.1	68.1	0.0	0.0	70.1	0.1	-5.6	0.0	0.0	0.0	0.0	-0.0	3.5	3.5
2	501813.68	5442842.44	2.60	0	125	78.9	78.9	0.0	0.0	70.1	0.4	4.7	0.0	0.0	0.0	0.0	-0.0	3.7	3.7
3	501813.68	5442842.44	2.60	0	250	85.5	85.5	0.0	0.0	70.1	0.9	6.5	0.0	0.0	0.0	0.0	-0.0	8.0	8.0
4	501813.68	5442842.44	2.60	0	500	87.3	87.3	0.0	0.0	70.1	1.7	2.2	0.0	0.0	0.0	0.0	-0.0	13.3	13.3
5	501813.68	5442842.44	2.60	0	1000	83.7	83.7	0.0	0.0	70.1	3.3	-1.2	0.0	0.0	0.0	0.0	-0.0	11.5	11.5
6	501813.68	5442842.44	2.60	0	2000	79.1	79.1	0.0	0.0	70.1	8.7	-1.7	0.0	0.0	0.0	0.0	-0.0	2.0	2.0
7	501813.68	5442842.44	2.60	0	4000	70.0	70.0	0.0	0.0	70.1	29.5	-1.7	0.0	0.0	0.0	0.0	-0.0	-27.9	-27.9
8	501813.68	5442842.44	2.60	0	8000	77.7	77.7	0.0	0.0	70.1	105.1	-1.7	0.0	0.0	0.0	0.0	-0.0	-95.8	-95.8

Point Source, ISO 9613, Name: "Ab_Inv3", ID: "Ab_Inv3"

Nr.	X (m)	Y (m)	Z (m)	Refl.	Freq. (Hz)	LxT dB(A)	LxN dB(A)	K0 (dB)	Dc (dB)	Adiv (dB)	Aatm (dB)	Agr (dB)	Afol (dB)	Ahous (dB)	Abar (dB)	Cmet (dB)	RL (dB)	LrT dB(A)	LrN dB(A)
1	501813.58	5443021.64	2.60	0	63	68.1	68.1	0.0	0.0	68.4	0.1	-5.5	0.0	0.0	0.0	0.0	-0.0	5.1	5.1
2	501813.58	5443021.64	2.60	0	125	78.9	78.9	0.0	0.0	68.4	0.3	4.1	0.0	0.0	0.0	0.0	-0.0	6.1	6.1
3	501813.58	5443021.64	2.60	0	250	85.5	85.5	0.0	0.0	68.4	0.8	6.5	0.0	0.0	0.0	0.0	-0.0	9.8	9.8
4	501813.58	5443021.64	2.60	0	500	87.3	87.3	0.0	0.0	68.4	1.4	2.3	0.0	0.0	0.0	0.0	-0.0	15.2	15.2
5	501813.58	5443021.64	2.60	0	1000	83.7	83.7	0.0	0.0	68.4	2.7	-1.2	0.0	0.0	0.0	0.0	-0.0	13.8	13.8
6	501813.58	5443021.64	2.60	0	2000	79.1	79.1	0.0	0.0	68.4	7.1	-1.7	0.0	0.0	0.0	0.0	-0.0	5.2	5.2
7	501813.58	5443021.64	2.60	0	4000	70.0	70.0	0.0	0.0	68.4	24.3	-1.7	0.0	0.0	0.0	0.0	-0.0	-21.0	-21.0
8	501813.58	5443021.64	2.60	0	8000	77.7	77.7	0.0	0.0	68.4	86.5	-1.7	0.0	0.0	0.0	0.0	-0.0	-75.5	-75.5

Point Source, ISO 9613, Name: "Ab_Inv4", ID: "Ab_Inv4"

Nr.	X (m)	Y (m)	Z (m)	Refl.	Freq. (Hz)	LxT dB(A)	LxN dB(A)	K0 (dB)	Dc (dB)	Adiv (dB)	Aatm (dB)	Agr (dB)	Afol (dB)	Ahous (dB)	Abar (dB)	Cmet (dB)	RL (dB)	LrT dB(A)	LrN dB(A)
1	501813.68	5443200.84	2.60	0	63	68.1	68.1	0.0	0.0	66.5	0.1	-5.4	0.0	0.0	0.0	0.0	-0.0	7.0	7.0
2	501813.68	5443200.84	2.60	0	125	78.9	78.9	0.0	0.0	66.5	0.2	3.3	0.0	0.0	0.0	0.0	-0.0	8.9	8.9
3	501813.68	5443200.84	2.60	0	250	85.5	85.5	0.0	0.0	66.5	0.6	6.6	0.0	0.0	0.0	0.0	-0.0	11.9	11.9
4	501813.68	5443200.84	2.60	0	500	87.3	87.3	0.0	0.0	66.5	1.1	2.3	0.0	0.0	0.0	0.0	-0.0	17.4	17.4

Point Source, ISO 9613, Name: "Ab_Inv4", ID: "Ab_Inv4"																			
Nr.	X	Y	Z	Refl.	Freq.	LxT	LxN	K0	Dc	Adiv	Aatm	Agr	Afol	Ahous	Abar	Cmet	RL	LrT	LrN
	(m)	(m)	(m)		(Hz)	dB(A)	dB(A)	(dB)	(dB)	(dB)	(dB)	(dB)	(dB)	(dB)	(dB)	(dB)	(dB)	dB(A)	dB(A)
5	501813.68	5443200.84	2.60	0	1000	83.7	83.7	0.0	0.0	66.5	2.2	-1.1	0.0	0.0	0.0	0.0	-0.0	16.2	16.2
6	501813.68	5443200.84	2.60	0	2000	79.1	79.1	0.0	0.0	66.5	5.7	-1.6	0.0	0.0	0.0	0.0	-0.0	8.5	8.5
7	501813.68	5443200.84	2.60	0	4000	70.0	70.0	0.0	0.0	66.5	19.4	-1.6	0.0	0.0	0.0	0.0	-0.0	-14.2	-14.2
8	501813.68	5443200.84	2.60	0	8000	77.7	77.7	0.0	0.0	66.5	69.2	-1.6	0.0	0.0	0.0	0.0	-0.0	-56.3	-56.3

Point Source, ISO 9613, Name: "Ab_Inv5", ID: "Ab_Inv5"																			
Nr.	X	Y	Z	Refl.	Freq.	LxT	LxN	K0	Dc	Adiv	Aatm	Agr	Afol	Ahous	Abar	Cmet	RL	LrT	LrN
	(m)	(m)	(m)		(Hz)	dB(A)	dB(A)	(dB)	(dB)	(dB)	(dB)	(dB)	(dB)	(dB)	(dB)	(dB)	(dB)	dB(A)	dB(A)
1	502235.01	5442875.04	2.60	0	63	68.1	68.1	0.0	0.0	68.9	0.1	-5.5	0.0	0.0	0.0	0.0	-0.0	4.6	4.6
2	502235.01	5442875.04	2.60	0	125	78.9	78.9	0.0	0.0	68.9	0.3	4.3	0.0	0.0	0.0	0.0	-0.0	5.3	5.3
3	502235.01	5442875.04	2.60	0	250	85.5	85.5	0.0	0.0	68.9	0.8	6.5	0.0	0.0	0.0	0.0	-0.0	9.2	9.2
4	502235.01	5442875.04	2.60	0	500	87.3	87.3	0.0	0.0	68.9	1.5	2.3	0.0	0.0	0.0	0.0	-0.0	14.6	14.6
5	502235.01	5442875.04	2.60	0	1000	83.7	83.7	0.0	0.0	68.9	2.9	-1.2	0.0	0.0	0.0	0.0	-0.0	13.1	13.1
6	502235.01	5442875.04	2.60	0	2000	79.1	79.1	0.0	0.0	68.9	7.6	-1.7	0.0	0.0	0.0	0.0	-0.0	4.2	4.2
7	502235.01	5442875.04	2.60	0	4000	70.0	70.0	0.0	0.0	68.9	25.8	-1.7	0.0	0.0	0.0	0.0	-0.0	-23.1	-23.1
8	502235.01	5442875.04	2.60	0	8000	77.7	77.7	0.0	0.0	68.9	92.0	-1.7	0.0	0.0	0.0	0.0	-0.0	-81.6	-81.6

Point Source, ISO 9613, Name: "Ab_Inv6", ID: "Ab_Inv6"																			
Nr.	X	Y	Z	Refl.	Freq.	LxT	LxN	K0	Dc	Adiv	Aatm	Agr	Afol	Ahous	Abar	Cmet	RL	LrT	LrN
	(m)	(m)	(m)		(Hz)	dB(A)	dB(A)	(dB)	(dB)	(dB)	(dB)	(dB)	(dB)	(dB)	(dB)	(dB)	(dB)	dB(A)	dB(A)
1	502235.01	5443065.44	2.60	0	63	68.1	68.1	0.0	0.0	66.5	0.1	-5.4	0.0	0.0	0.0	0.0	-0.0	6.9	6.9
2	502235.01	5443065.44	2.60	0	125	78.9	78.9	0.0	0.0	66.5	0.3	3.3	0.0	0.0	0.0	0.0	-0.0	8.8	8.8
3	502235.01	5443065.44	2.60	0	250	85.5	85.5	0.0	0.0	66.5	0.6	6.6	0.0	0.0	0.0	0.0	-0.0	11.8	11.8
4	502235.01	5443065.44	2.60	0	500	87.3	87.3	0.0	0.0	66.5	1.2	2.3	0.0	0.0	0.0	0.0	-0.0	17.3	17.3
5	502235.01	5443065.44	2.60	0	1000	83.7	83.7	0.0	0.0	66.5	2.2	-1.1	0.0	0.0	0.0	0.0	-0.0	16.1	16.1
6	502235.01	5443065.44	2.60	0	2000	79.1	79.1	0.0	0.0	66.5	5.8	-1.6	0.0	0.0	0.0	0.0	-0.0	8.4	8.4
7	502235.01	5443065.44	2.60	0	4000	70.0	70.0	0.0	0.0	66.5	19.6	-1.6	0.0	0.0	0.0	0.0	-0.0	-14.5	-14.5
8	502235.01	5443065.44	2.60	0	8000	77.7	77.7	0.0	0.0	66.5	69.8	-1.6	0.0	0.0	0.0	0.0	-0.0	-57.0	-57.0

Point Source, ISO 9613, Name: "Ab_Inv7", ID: "Ab_Inv7"																			
Nr.	X	Y	Z	Refl.	Freq.	LxT	LxN	K0	Dc	Adiv	Aatm	Agr	Afol	Ahous	Abar	Cmet	RL	LrT	LrN
	(m)	(m)	(m)		(Hz)	dB(A)	dB(A)	(dB)	(dB)	(dB)	(dB)	(dB)	(dB)	(dB)	(dB)	(dB)	(dB)	dB(A)	dB(A)
1	502235.01	5443257.84	2.60	0	63	68.1	68.1	0.0	0.0	63.2	0.1	-5.1	0.0	0.0	0.0	0.0	-0.0	10.0	10.0
2	502235.01	5443257.84	2.60	0	125	78.9	78.9	0.0	0.0	63.2	0.2	2.0	0.0	0.0	0.0	0.0	-0.0	13.6	13.6
3	502235.01	5443257.84	2.60	0	250	85.5	85.5	0.0	0.0	63.2	0.4	6.7	0.0	0.0	0.0	0.0	-0.0	15.3	15.3
4	502235.01	5443257.84	2.60	0	500	87.3	87.3	0.0	0.0	63.2	0.8	2.4	0.0	0.0	0.0	0.0	-0.0	21.0	21.0
5	502235.01	5443257.84	2.60	0	1000	83.7	83.7	0.0	0.0	63.2	1.5	-1.1	0.0	0.0	0.0	0.0	-0.0	20.1	20.1
6	502235.01	5443257.84	2.60	0	2000	79.1	79.1	0.0	0.0	63.2	3.9	-1.5	0.0	0.0	0.0	0.0	-0.0	13.5	13.5
7	502235.01	5443257.84	2.60	0	4000	70.0	70.0	0.0	0.0	63.2	13.3	-1.5	0.0	0.0	0.0	0.0	-0.0	-4.9	-4.9
8	502235.01	5443257.84	2.60	0	8000	77.7	77.7	0.0	0.0	63.2	47.4	-1.5	0.0	0.0	0.0	0.0	-0.0	-31.4	-31.4

Point Source, ISO 9613, Name: "Ab_Trans1", ID: "Ab_Trans1"																			
Nr.	X	Y	Z	Refl.	Freq.	LxT	LxN	K0	Dc	Adiv	Aatm	Agr	Afol	Ahous	Abar	Cmet	RL	LrT	LrN
	(m)	(m)	(m)		(Hz)	dB(A)	dB(A)	(dB)	(dB)	(dB)	(dB)	(dB)	(dB)	(dB)	(dB)	(dB)	(dB)	dB(A)	dB(A)
1	501819.18	5442662.74	2.58	0	32	37.3	37.3	0.0	0.0	71.5	0.0	-5.6	0.0	0.0	0.0	0.0	-0.0	-28.6	-28.6
2	501819.18	5442662.74	2.58	0	63	56.5	56.5	0.0	0.0	71.5	0.1	-5.6	0.0	0.0	0.0	0.0	-0.0	-9.5	-9.5
3	501819.18	5442662.74	2.58	0	125	68.6	68.6	0.0	0.0	71.5	0.4	5.0	0.0	0.0	0.0	0.0	-0.0	-8.4	-8.4
4	501819.18	5442662.74	2.58	0	250	71.1	71.1	0.0	0.0	71.5	1.1	6.5	0.0	0.0	0.0	0.0	-0.0	-8.1	-8.1
5	501819.18	5442662.74	2.58	0	500	76.5	76.5	0.0	0.0	71.5	2.0	2.2	0.0	0.0	0.0	0.0	-0.0	0.7	0.7
6	501819.18	5442662.74	2.58	0	1000	73.7	73.7	0.0	0.0	71.5	3.9	-1.2	0.0	0.0	0.0	0.0	-0.0	-0.5	-0.5
7	501819.18	5442662.74	2.58	0	2000	69.9	69.9	0.0	0.0	71.5	10.3	-1.7	0.0	0.0	0.0	0.0	-0.0	-10.2	-10.2
8	501819.18	5442662.74	2.58	0	4000	64.7	64.7	0.0	0.0	71.5	34.8	-1.7	0.0	0.0	0.0	0.0	-0.0	-40.0	-40.0
9	501819.18	5442662.74	2.58	0	8000	55.6	55.6	0.0	0.0	71.5	124.3	-1.7	0.0	0.0	0.0	0.0	-0.0	-138.5	-138.5

Point Source, ISO 9613, Name: "Ab_Trans2", ID: "Ab_Trans2"																			
Nr.	X	Y	Z	Refl.	Freq.	LxT	LxN	K0	Dc	Adiv	Aatm	Agr	Afol	Ahous	Abar	Cmet	RL	LrT	LrN
	(m)	(m)	(m)		(Hz)	dB(A)	dB(A)	(dB)	(dB)	(dB)	(dB)	(dB)	(dB)	(dB)	(dB)	(dB)	(dB)	dB(A)	dB(A)
1	501819.18	5442841.94	2.58	0	32	37.3	37.3	0.0	0.0	70.1	0.0	-5.6	0.0	0.0	0.0	0.0	-0.0	-27.2	-27.2
2	501819.18	5442841.94	2.58	0	63	56.5	56.5	0.0	0.0	70.1	0.1	-5.6	0.0	0.0	0.0	0.0	-0.0	-8.1	-8.1
3	501819.18	5442841.94	2.58	0	125	68.6	68.6	0.0	0.0	70.1	0.4	4.7	0.0	0.0	0.0	0.0	-0.0	-6.5	-6.5
4	501819.18	5442841.94	2.58	0	250	71.1	71.1	0.0	0.0	70.1	0.9	6.5	0.0	0.0	0.0	0.0	-0.0	-6.4	-6.4
5	501819.18	5442841.94	2.58	0	500	76.5	76.5	0.0	0.0	70.1	1.7	2.3	0.0	0.0	0.0	0.0	-0.0	2.4	2.4
6	501819.18	5442841.94	2.58	0	1000	73.7	73.7	0.0	0.0	70.1	3.3	-1.2	0.0	0.0	0.0	0.0	-0.0	1.6	1.6

Point Source, ISO 9613, Name: "Ab_Trans2", ID: "Ab_Trans2"																			
Nr.	X	Y	Z	Refl.	Freq.	LxT	LxN	K0	Dc	Adiv	Aatm	Agr	Afol	Ahous	Abar	Cmet	RL	LrT	LrN
	(m)	(m)	(m)		(Hz)	dB(A)	dB(A)	(dB)	(dB)	(dB)	(dB)	(dB)	(dB)	(dB)	(dB)	(dB)	(dB)	dB(A)	dB(A)
7	501819.18	5442841.94	2.58	0	2000	69.9	69.9	0.0	0.0	70.1	8.7	-1.7	0.0	0.0	0.0	0.0	-0.0	-7.2	-7.2
8	501819.18	5442841.94	2.58	0	4000	64.7	64.7	0.0	0.0	70.1	29.4	-1.7	0.0	0.0	0.0	0.0	-0.0	-33.1	-33.1
9	501819.18	5442841.94	2.58	0	8000	55.6	55.6	0.0	0.0	70.1	104.9	-1.7	0.0	0.0	0.0	0.0	-0.0	-117.7	-117.7

Point Source, ISO 9613, Name: "Ab_Trans3", ID: "Ab_Trans3"																			
Nr.	X	Y	Z	Refl.	Freq.	LxT	LxN	K0	Dc	Adiv	Aatm	Agr	Afol	Ahous	Abar	Cmet	RL	LrT	LrN
	(m)	(m)	(m)		(Hz)	dB(A)	dB(A)	(dB)	(dB)	(dB)	(dB)	(dB)	(dB)	(dB)	(dB)	(dB)	(dB)	dB(A)	dB(A)
1	501819.08	5443021.14	2.58	0	32	37.3	37.3	0.0	0.0	68.4	0.0	-5.5	0.0	0.0	0.0	0.0	-0.0	-25.6	-25.6
2	501819.08	5443021.14	2.58	0	63	56.5	56.5	0.0	0.0	68.4	0.1	-5.5	0.0	0.0	0.0	0.0	-0.0	-6.4	-6.4
3	501819.08	5443021.14	2.58	0	125	68.6	68.6	0.0	0.0	68.4	0.3	4.1	0.0	0.0	0.0	0.0	-0.0	-4.2	-4.2
4	501819.08	5443021.14	2.58	0	250	71.1	71.1	0.0	0.0	68.4	0.8	6.6	0.0	0.0	0.0	0.0	-0.0	-4.6	-4.6
5	501819.08	5443021.14	2.58	0	500	76.5	76.5	0.0	0.0	68.4	1.4	2.3	0.0	0.0	0.0	0.0	-0.0	4.4	4.4
6	501819.08	5443021.14	2.58	0	1000	73.7	73.7	0.0	0.0	68.4	2.7	-1.2	0.0	0.0	0.0	0.0	-0.0	3.8	3.8
7	501819.08	5443021.14	2.58	0	2000	69.9	69.9	0.0	0.0	68.4	7.1	-1.7	0.0	0.0	0.0	0.0	-0.0	-3.9	-3.9
8	501819.08	5443021.14	2.58	0	4000	64.7	64.7	0.0	0.0	68.4	24.2	-1.7	0.0	0.0	0.0	0.0	-0.0	-26.2	-26.2
9	501819.08	5443021.14	2.58	0	8000	55.6	55.6	0.0	0.0	68.4	86.2	-1.7	0.0	0.0	0.0	0.0	-0.0	-97.3	-97.3

Point Source, ISO 9613, Name: "Ab_Trans4", ID: "Ab_Trans4"																			
Nr.	X	Y	Z	Refl.	Freq.	LxT	LxN	K0	Dc	Adiv	Aatm	Agr	Afol	Ahous	Abar	Cmet	RL	LrT	LrN
	(m)	(m)	(m)		(Hz)	dB(A)	dB(A)	(dB)	(dB)	(dB)	(dB)	(dB)	(dB)	(dB)	(dB)	(dB)	(dB)	dB(A)	dB(A)
1	501819.18	5443200.34	2.58	0	32	37.3	37.3	0.0	0.0	66.4	0.0	-5.4	0.0	0.0	0.0	0.0	-0.0	-23.8	-23.8
2	501819.18	5443200.34	2.58	0	63	56.5	56.5	0.0	0.0	66.4	0.1	-5.4	0.0	0.0	0.0	0.0	-0.0	-4.6	-4.6
3	501819.18	5443200.34	2.58	0	125	68.6	68.6	0.0	0.0	66.4	0.2	3.3	0.0	0.0	0.0	0.0	-0.0	-1.3	-1.3
4	501819.18	5443200.34	2.58	0	250	71.1	71.1	0.0	0.0	66.4	0.6	6.6	0.0	0.0	0.0	0.0	-0.0	-2.5	-2.5
5	501819.18	5443200.34	2.58	0	500	76.5	76.5	0.0	0.0	66.4	1.1	2.3	0.0	0.0	0.0	0.0	-0.0	6.6	6.6
6	501819.18	5443200.34	2.58	0	1000	73.7	73.7	0.0	0.0	66.4	2.1	-1.1	0.0	0.0	0.0	0.0	-0.0	6.3	6.3
7	501819.18	5443200.34	2.58	0	2000	69.9	69.9	0.0	0.0	66.4	5.7	-1.6	0.0	0.0	0.0	0.0	-0.0	-0.6	-0.6
8	501819.18	5443200.34	2.58	0	4000	64.7	64.7	0.0	0.0	66.4	19.3	-1.6	0.0	0.0	0.0	0.0	-0.0	-19.4	-19.4
9	501819.18	5443200.34	2.58	0	8000	55.6	55.6	0.0	0.0	66.4	68.8	-1.6	0.0	0.0	0.0	0.0	-0.0	-78.0	-78.0

Point Source, ISO 9613, Name: "Ab_Trans5", ID: "Ab_Trans5"																			
Nr.	X	Y	Z	Refl.	Freq.	LxT	LxN	K0	Dc	Adiv	Aatm	Agr	Afol	Ahous	Abar	Cmet	RL	LrT	LrN
	(m)	(m)	(m)		(Hz)	dB(A)	dB(A)	(dB)	(dB)	(dB)	(dB)	(dB)	(dB)	(dB)	(dB)	(dB)	(dB)	dB(A)	dB(A)
1	502229.51	5442875.54	2.58	0	32	37.3	37.3	0.0	0.0	68.9	0.0	-5.5	0.0	0.0	0.0	0.0	-0.0	-26.1	-26.1
2	502229.51	5442875.54	2.58	0	63	56.5	56.5	0.0	0.0	68.9	0.1	-5.5	0.0	0.0	0.0	0.0	-0.0	-7.0	-7.0
3	502229.51	5442875.54	2.58	0	125	68.6	68.6	0.0	0.0	68.9	0.3	4.3	0.0	0.0	0.0	0.0	-0.0	-5.0	-5.0
4	502229.51	5442875.54	2.58	0	250	71.1	71.1	0.0	0.0	68.9	0.8	6.6	0.0	0.0	0.0	0.0	-0.0	-5.2	-5.2
5	502229.51	5442875.54	2.58	0	500	76.5	76.5	0.0	0.0	68.9	1.5	2.3	0.0	0.0	0.0	0.0	-0.0	3.8	3.8
6	502229.51	5442875.54	2.58	0	1000	73.7	73.7	0.0	0.0	68.9	2.9	-1.2	0.0	0.0	0.0	0.0	-0.0	3.1	3.1
7	502229.51	5442875.54	2.58	0	2000	69.9	69.9	0.0	0.0	68.9	7.6	-1.7	0.0	0.0	0.0	0.0	-0.0	-5.0	-5.0
8	502229.51	5442875.54	2.58	0	4000	64.7	64.7	0.0	0.0	68.9	25.8	-1.7	0.0	0.0	0.0	0.0	-0.0	-28.3	-28.3
9	502229.51	5442875.54	2.58	0	8000	55.6	55.6	0.0	0.0	68.9	91.9	-1.7	0.0	0.0	0.0	0.0	-0.0	-103.6	-103.6

Point Source, ISO 9613, Name: "Ab_Trans6", ID: "Ab_Trans6"																			
Nr.	X	Y	Z	Refl.	Freq.	LxT	LxN	K0	Dc	Adiv	Aatm	Agr	Afol	Ahous	Abar	Cmet	RL	LrT	LrN
	(m)	(m)	(m)		(Hz)	dB(A)	dB(A)	(dB)	(dB)	(dB)	(dB)	(dB)	(dB)	(dB)	(dB)	(dB)	(dB)	dB(A)	dB(A)
1	502229.51	5443065.94	2.58	0	32	37.3	37.3	0.0	0.0	66.5	0.0	-5.4	0.0	0.0	0.0	0.0	-0.0	-23.8	-23.8
2	502229.51	5443065.94	2.58	0	63	56.5	56.5	0.0	0.0	66.5	0.1	-5.4	0.0	0.0	0.0	0.0	-0.0	-4.7	-4.7
3	502229.51	5443065.94	2.58	0	125	68.6	68.6	0.0	0.0	66.5	0.3	3.3	0.0	0.0	0.0	0.0	-0.0	-1.5	-1.5
4	502229.51	5443065.94	2.58	0	250	71.1	71.1	0.0	0.0	66.5	0.6	6.6	0.0	0.0	0.0	0.0	-0.0	-2.6	-2.6
5	502229.51	5443065.94	2.58	0	500	76.5	76.5	0.0	0.0	66.5	1.2	2.3	0.0	0.0	0.0	0.0	-0.0	6.5	6.5
6	502229.51	5443065.94	2.58	0	1000	73.7	73.7	0.0	0.0	66.5	2.2	-1.1	0.0	0.0	0.0	0.0	-0.0	6.1	6.1
7	502229.51	5443065.94	2.58	0	2000	69.9	69.9	0.0	0.0	66.5	5.8	-1.6	0.0	0.0	0.0	0.0	-0.0	-0.8	-0.8
8	502229.51	5443065.94	2.58	0	4000	64.7	64.7	0.0	0.0	66.5	19.5	-1.6	0.0	0.0	0.0	0.0	-0.0	-19.7	-19.7
9	502229.51	5443065.94	2.58	0	8000	55.6	55.6	0.0	0.0	66.5	69.7	-1.6	0.0	0.0	0.0	0.0	-0.0	-79.0	-79.0

Point Source, ISO 9613, Name: "Ab_Trans7", ID: "Ab_Trans7"																			
Nr.	X	Y	Z	Refl.	Freq.	LxT	LxN	K0	Dc	Adiv	Aatm	Agr	Afol	Ahous	Abar	Cmet	RL	LrT	LrN
	(m)	(m)	(m)		(Hz)	dB(A)	dB(A)	(dB)	(dB)	(dB)	(dB)	(dB)	(dB)	(dB)	(dB)	(dB)	(dB)	dB(A)	dB(A)
1	502229.51	5443258.34	2.58	0	32	37.3	37.3	0.0	0.0	63.1	0.0	-5.1	0.0	0.0	0.0	0.0	-0.0	-20.8	-20.8
2	502229.51	5443258.34	2.58	0	63	56.5	56.5	0.0	0.0	63.1	0.1	-5.1	0.0	0.0	0.0	0.0	-0.0	-1.6	-1.6
3	502229.51	5443258.34	2.58	0	125	68.6	68.6	0.0	0.0	63.1	0.2	2.0	0.0	0.0	0.0	0.0	-0.0	3.3	3.3
4	502229.51	5443258.34	2.58	0	250	71.1	71.1	0.0	0.0	63.1	0.4	6.7	0.0	0.0	0.0	0.0	-0.0	0.8	0.8

Point Source, ISO 9613, Name: "Ab_Trans7", ID: "Ab_Trans7"																			
Nr.	X	Y	Z	Refl.	Freq.	LxT	LxN	K0	Dc	Adiv	Aatm	Agr	Afol	Ahous	Abar	Cmet	RL	LrT	LrN
	(m)	(m)	(m)		(Hz)	dB(A)	dB(A)	(dB)	(dB)	(dB)	(dB)	(dB)	(dB)	(dB)	(dB)	(dB)	(dB)	dB(A)	dB(A)
5	502229.51	5443258.34	2.58	0	500	76.5	76.5	0.0	0.0	63.1	0.8	2.4	0.0	0.0	0.0	0.0	-0.0	10.2	10.2
6	502229.51	5443258.34	2.58	0	1000	73.7	73.7	0.0	0.0	63.1	1.5	-1.1	0.0	0.0	0.0	0.0	-0.0	10.1	10.1
7	502229.51	5443258.34	2.58	0	2000	69.9	69.9	0.0	0.0	63.1	3.9	-1.5	0.0	0.0	0.0	0.0	-0.0	4.4	4.4
8	502229.51	5443258.34	2.58	0	4000	64.7	64.7	0.0	0.0	63.1	13.3	-1.5	0.0	0.0	0.0	0.0	-0.0	-10.2	-10.2
9	502229.51	5443258.34	2.58	0	8000	55.6	55.6	0.0	0.0	63.1	47.3	-1.5	0.0	0.0	0.0	0.0	-0.0	-53.3	-53.3

Point Source, ISO 9613, Name: "Em_Sub115", ID: "Em_Sub115"																			
Nr.	X	Y	Z	Refl.	Freq.	LxT	LxN	K0	Dc	Adiv	Aatm	Agr	Afol	Ahous	Abar	Cmet	RL	LrT	LrN
	(m)	(m)	(m)		(Hz)	dB(A)	dB(A)	(dB)	(dB)	(dB)	(dB)	(dB)	(dB)	(dB)	(dB)	(dB)	(dB)	dB(A)	dB(A)
1	500978.58	5443536.29	3.60	0	32	43.3	43.3	0.0	0.0	72.7	0.0	-5.6	0.0	0.0	0.0	0.0	-0.0	-23.8	-23.8
2	500978.58	5443536.29	3.60	0	63	60.5	60.5	0.0	0.0	72.7	0.2	-5.6	0.0	0.0	0.0	0.0	-0.0	-6.7	-6.7
3	500978.58	5443536.29	3.60	0	125	73.6	73.6	0.0	0.0	72.7	0.5	4.9	0.0	0.0	0.0	0.0	-0.0	-4.5	-4.5
4	500978.58	5443536.29	3.60	0	250	79.1	79.1	0.0	0.0	72.7	1.3	5.1	0.0	0.0	0.0	0.0	-0.0	0.0	0.0
5	500978.58	5443536.29	3.60	0	500	84.5	84.5	0.0	0.0	72.7	2.3	1.8	0.0	0.0	0.0	0.0	-0.0	7.6	7.6
6	500978.58	5443536.29	3.60	0	1000	81.7	81.7	0.0	0.0	72.7	4.4	-1.2	0.0	0.0	0.0	0.0	-0.0	5.8	5.8
7	500978.58	5443536.29	3.60	0	2000	77.9	77.9	0.0	0.0	72.7	11.7	-1.7	0.0	0.0	0.0	0.0	-0.0	-4.8	-4.8
8	500978.58	5443536.29	3.60	0	4000	72.7	72.7	0.0	0.0	72.7	39.8	-1.7	0.0	0.0	0.0	0.0	-0.0	-38.1	-38.1
9	500978.58	5443536.29	3.60	0	8000	62.6	62.6	0.0	0.0	72.7	142.0	-1.7	0.0	0.0	0.0	0.0	-0.0	-150.4	-150.4

Point Source, ISO 9613, Name: "Em_Inv1", ID: "Em_Inv1"																			
Nr.	X	Y	Z	Refl.	Freq.	LxT	LxN	K0	Dc	Adiv	Aatm	Agr	Afol	Ahous	Abar	Cmet	RL	LrT	LrN
	(m)	(m)	(m)		(Hz)	dB(A)	dB(A)	(dB)	(dB)	(dB)	(dB)	(dB)	(dB)	(dB)	(dB)	(dB)	(dB)	dB(A)	dB(A)
1	500760.53	5441418.41	2.60	0	63	68.1	68.1	0.0	0.0	79.5	0.3	-5.9	0.0	0.0	0.0	0.0	-0.0	-5.8	-5.8
2	500760.53	5441418.41	2.60	0	125	78.9	78.9	0.0	0.0	79.5	1.1	5.2	0.0	0.0	0.0	0.0	-0.0	-6.9	-6.9
3	500760.53	5441418.41	2.60	0	250	85.5	85.5	0.0	0.0	79.5	2.8	6.4	0.0	0.0	0.0	0.0	-0.0	-3.2	-3.2
4	500760.53	5441418.41	2.60	0	500	87.3	87.3	0.0	0.0	79.5	5.1	2.2	0.0	0.0	0.0	0.0	-0.0	0.5	0.5
5	500760.53	5441418.41	2.60	0	1000	83.7	83.7	0.0	0.0	79.5	9.7	-1.3	0.0	0.0	0.0	0.0	-0.0	-4.2	-4.2
6	500760.53	5441418.41	2.60	0	2000	79.1	79.1	0.0	0.0	79.5	25.7	-1.8	0.0	0.0	0.0	0.0	-0.0	-24.3	-24.3
7	500760.53	5441418.41	2.60	0	4000	70.0	70.0	0.0	0.0	79.5	87.1	-1.8	0.0	0.0	0.0	0.0	-0.0	-94.8	-94.8
8	500760.53	5441418.41	2.60	0	8000	77.7	77.7	0.0	0.0	79.5	310.6	-1.8	0.0	0.0	0.0	0.0	-0.0	-310.6	-310.6

Point Source, ISO 9613, Name: "Em_Inv2", ID: "Em_Inv2"																			
Nr.	X	Y	Z	Refl.	Freq.	LxT	LxN	K0	Dc	Adiv	Aatm	Agr	Afol	Ahous	Abar	Cmet	RL	LrT	LrN
	(m)	(m)	(m)		(Hz)	dB(A)	dB(A)	(dB)	(dB)	(dB)	(dB)	(dB)	(dB)	(dB)	(dB)	(dB)	(dB)	dB(A)	dB(A)
1	500552.40	5441520.21	2.60	0	63	68.1	68.1	0.0	0.0	79.6	0.3	-5.9	0.0	0.0	0.0	0.0	-0.0	-6.0	-6.0
2	500552.40	5441520.21	2.60	0	125	78.9	78.9	0.0	0.0	79.6	1.1	5.2	0.0	0.0	0.0	0.0	-0.0	-7.0	-7.0
3	500552.40	5441520.21	2.60	0	250	85.5	85.5	0.0	0.0	79.6	2.8	6.4	0.0	0.0	0.0	0.0	-0.0	-3.3	-3.3
4	500552.40	5441520.21	2.60	0	500	87.3	87.3	0.0	0.0	79.6	5.2	2.2	0.0	0.0	0.0	0.0	-0.0	0.3	0.3
5	500552.40	5441520.21	2.60	0	1000	83.7	83.7	0.0	0.0	79.6	9.9	-1.3	0.0	0.0	0.0	0.0	-0.0	-4.5	-4.5
6	500552.40	5441520.21	2.60	0	2000	79.1	79.1	0.0	0.0	79.6	26.0	-1.8	0.0	0.0	0.0	0.0	-0.0	-24.8	-24.8
7	500552.40	5441520.21	2.60	0	4000	70.0	70.0	0.0	0.0	79.6	88.3	-1.8	0.0	0.0	0.0	0.0	-0.0	-96.1	-96.1
8	500552.40	5441520.21	2.60	0	8000	77.7	77.7	0.0	0.0	79.6	314.8	-1.8	0.0	0.0	0.0	0.0	-0.0	-314.9	-314.9

Point Source, ISO 9613, Name: "Em_Inv3", ID: "Em_Inv3"																			
Nr.	X	Y	Z	Refl.	Freq.	LxT	LxN	K0	Dc	Adiv	Aatm	Agr	Afol	Ahous	Abar	Cmet	RL	LrT	LrN
	(m)	(m)	(m)		(Hz)	dB(A)	dB(A)	(dB)	(dB)	(dB)	(dB)	(dB)	(dB)	(dB)	(dB)	(dB)	(dB)	dB(A)	dB(A)
1	500760.53	5441687.21	2.60	0	63	68.1	68.1	0.0	0.0	78.7	0.3	-5.8	0.0	0.0	0.0	0.0	-0.0	-5.1	-5.1
2	500760.53	5441687.21	2.60	0	125	78.9	78.9	0.0	0.0	78.7	1.0	5.2	0.0	0.0	0.0	0.0	-0.0	-6.0	-6.0
3	500760.53	5441687.21	2.60	0	250	85.5	85.5	0.0	0.0	78.7	2.5	6.4	0.0	0.0	0.0	0.0	-0.0	-2.2	-2.2
4	500760.53	5441687.21	2.60	0	500	87.3	87.3	0.0	0.0	78.7	4.7	2.2	0.0	0.0	0.0	0.0	-0.0	1.7	1.7
5	500760.53	5441687.21	2.60	0	1000	83.7	83.7	0.0	0.0	78.7	8.9	-1.3	0.0	0.0	0.0	0.0	-0.0	-2.6	-2.6
6	500760.53	5441687.21	2.60	0	2000	79.1	79.1	0.0	0.0	78.7	23.5	-1.8	0.0	0.0	0.0	0.0	-0.0	-21.4	-21.4
7	500760.53	5441687.21	2.60	0	4000	70.0	70.0	0.0	0.0	78.7	79.8	-1.8	0.0	0.0	0.0	0.0	-0.0	-86.8	-86.8
8	500760.53	5441687.21	2.60	0	8000	77.7	77.7	0.0	0.0	78.7	284.6	-1.8	0.0	0.0	0.0	0.0	-0.0	-283.9	-283.9

Point Source, ISO 9613, Name: "Em_Inv4", ID: "Em_Inv4"																			
Nr.	X	Y	Z	Refl.	Freq.	LxT	LxN	K0	Dc	Adiv	Aatm	Agr	Afol	Ahous	Abar	Cmet	RL	LrT	LrN
	(m)	(m)	(m)		(Hz)	dB(A)	dB(A)	(dB)	(dB)	(dB)	(dB)	(dB)	(dB)	(dB)	(dB)	(dB)	(dB)	dB(A)	dB(A)
1	500516.20	5441733.01	2.60	0	63	68.1	68.1	0.0	0.0	79.1	0.3	-5.9	0.0	0.0	0.0	0.0	-0.0	-5.5	-5.5
2	500516.20	5441733.01	2.60	0	125	78.9	78.9	0.0	0.0	79.1	1.1	5.2	0.0	0.0	0.0	0.0	-0.0	-6.5	-6.5
3	500516.20	5441733.01	2.60	0	250	85.5	85.5	0.0	0.0	79.1	2.7	6.4	0.0	0.0	0.0	0.0	-0.0	-2.7	-2.7
4	500516.20	5441733.01	2.60	0	500	87.3	87.3	0.0	0.0	79.1	4.9	2.2	0.0	0.0	0.0	0.0	-0.0	1.1	1.1
5	500516.20	5441733.01	2.60	0	1000	83.7	83.7	0.0	0.0	79.1	9.3	-1.3	0.0	0.0	0.0	0.0	-0.0	-3.5	-3.5

Point Source, ISO 9613, Name: "Em_Inv4", ID: "Em_Inv4"																			
Nr.	X	Y	Z	Refl.	Freq.	LxT	LxN	K0	Dc	Adiv	Aatm	Agr	Afol	Ahous	Abar	Cmet	RL	LrT	LrN
	(m)	(m)	(m)		(Hz)	dB(A)	dB(A)	(dB)	(dB)	(dB)	(dB)	(dB)	(dB)	(dB)	(dB)	(dB)	(dB)	dB(A)	dB(A)
6	500516.20	5441733.01	2.60	0	2000	79.1	79.1	0.0	0.0	79.1	24.7	-1.8	0.0	0.0	0.0	0.0	-0.0	-22.9	-22.9
7	500516.20	5441733.01	2.60	0	4000	70.0	70.0	0.0	0.0	79.1	83.6	-1.8	0.0	0.0	0.0	0.0	-0.0	-91.0	-91.0
8	500516.20	5441733.01	2.60	0	8000	77.7	77.7	0.0	0.0	79.1	298.1	-1.8	0.0	0.0	0.0	0.0	-0.0	-297.8	-297.8

Point Source, ISO 9613, Name: "Em_Inv5", ID: "Em_Inv5"																			
Nr.	X	Y	Z	Refl.	Freq.	LxT	LxN	K0	Dc	Adiv	Aatm	Agr	Afol	Ahous	Abar	Cmet	RL	LrT	LrN
	(m)	(m)	(m)		(Hz)	dB(A)	dB(A)	(dB)	(dB)	(dB)	(dB)	(dB)	(dB)	(dB)	(dB)	(dB)	(dB)	dB(A)	dB(A)
1	500760.53	5441956.01	2.60	0	63	68.1	68.1	0.0	0.0	77.9	0.3	-5.8	0.0	0.0	0.0	0.0	-0.0	-4.3	-4.3
2	500760.53	5441956.01	2.60	0	125	78.9	78.9	0.0	0.0	77.9	0.9	5.2	0.0	0.0	0.0	0.0	-0.0	-5.2	-5.2
3	500760.53	5441956.01	2.60	0	250	85.5	85.5	0.0	0.0	77.9	2.3	6.4	0.0	0.0	0.0	0.0	-0.0	-1.2	-1.2
4	500760.53	5441956.01	2.60	0	500	87.3	87.3	0.0	0.0	77.9	4.3	2.2	0.0	0.0	0.0	0.0	-0.0	2.9	2.9
5	500760.53	5441956.01	2.60	0	1000	83.7	83.7	0.0	0.0	77.9	8.1	-1.3	0.0	0.0	0.0	0.0	-0.0	-1.1	-1.1
6	500760.53	5441956.01	2.60	0	2000	79.1	79.1	0.0	0.0	77.9	21.5	-1.8	0.0	0.0	0.0	0.0	-0.0	-18.6	-18.6
7	500760.53	5441956.01	2.60	0	4000	70.0	70.0	0.0	0.0	77.9	72.8	-1.8	0.0	0.0	0.0	0.0	-0.0	-79.0	-79.0
8	500760.53	5441956.01	2.60	0	8000	77.7	77.7	0.0	0.0	77.9	259.8	-1.8	0.0	0.0	0.0	0.0	-0.0	-258.3	-258.3

Point Source, ISO 9613, Name: "Em_Inv6", ID: "Em_Inv6"																			
Nr.	X	Y	Z	Refl.	Freq.	LxT	LxN	K0	Dc	Adiv	Aatm	Agr	Afol	Ahous	Abar	Cmet	RL	LrT	LrN
	(m)	(m)	(m)		(Hz)	dB(A)	dB(A)	(dB)	(dB)	(dB)	(dB)	(dB)	(dB)	(dB)	(dB)	(dB)	(dB)	dB(A)	dB(A)
1	500498.10	5441901.01	2.60	0	63	68.1	68.1	0.0	0.0	78.7	0.3	-5.8	0.0	0.0	0.0	0.0	-0.0	-5.1	-5.1
2	500498.10	5441901.01	2.60	0	125	78.9	78.9	0.0	0.0	78.7	1.0	5.2	0.0	0.0	0.0	0.0	-0.0	-6.1	-6.1
3	500498.10	5441901.01	2.60	0	250	85.5	85.5	0.0	0.0	78.7	2.5	6.4	0.0	0.0	0.0	0.0	-0.0	-2.2	-2.2
4	500498.10	5441901.01	2.60	0	500	87.3	87.3	0.0	0.0	78.7	4.7	2.2	0.0	0.0	0.0	0.0	-0.0	1.7	1.7
5	500498.10	5441901.01	2.60	0	1000	83.7	83.7	0.0	0.0	78.7	8.9	-1.3	0.0	0.0	0.0	0.0	-0.0	-2.7	-2.7
6	500498.10	5441901.01	2.60	0	2000	79.1	79.1	0.0	0.0	78.7	23.6	-1.8	0.0	0.0	0.0	0.0	-0.0	-21.5	-21.5
7	500498.10	5441901.01	2.60	0	4000	70.0	70.0	0.0	0.0	78.7	79.9	-1.8	0.0	0.0	0.0	0.0	-0.0	-86.9	-86.9
8	500498.10	5441901.01	2.60	0	8000	77.7	77.7	0.0	0.0	78.7	285.1	-1.8	0.0	0.0	0.0	0.0	-0.0	-284.3	-284.3

Point Source, ISO 9613, Name: "Em_Inv7", ID: "Em_Inv7"																			
Nr.	X	Y	Z	Refl.	Freq.	LxT	LxN	K0	Dc	Adiv	Aatm	Agr	Afol	Ahous	Abar	Cmet	RL	LrT	LrN
	(m)	(m)	(m)		(Hz)	dB(A)	dB(A)	(dB)	(dB)	(dB)	(dB)	(dB)	(dB)	(dB)	(dB)	(dB)	(dB)	dB(A)	dB(A)
1	500498.10	5442057.81	2.60	0	63	68.1	68.1	0.0	0.0	78.3	0.3	-5.8	0.0	0.0	0.0	0.0	-0.0	-4.7	-4.7
2	500498.10	5442057.81	2.60	0	125	78.9	78.9	0.0	0.0	78.3	1.0	5.2	0.0	0.0	0.0	0.0	-0.0	-5.6	-5.6
3	500498.10	5442057.81	2.60	0	250	85.5	85.5	0.0	0.0	78.3	2.4	6.4	0.0	0.0	0.0	0.0	-0.0	-1.7	-1.7
4	500498.10	5442057.81	2.60	0	500	87.3	87.3	0.0	0.0	78.3	4.5	2.2	0.0	0.0	0.0	0.0	-0.0	2.3	2.3
5	500498.10	5442057.81	2.60	0	1000	83.7	83.7	0.0	0.0	78.3	8.5	-1.3	0.0	0.0	0.0	0.0	-0.0	-1.9	-1.9
6	500498.10	5442057.81	2.60	0	2000	79.1	79.1	0.0	0.0	78.3	22.5	-1.8	0.0	0.0	0.0	0.0	-0.0	-20.0	-20.0
7	500498.10	5442057.81	2.60	0	4000	70.0	70.0	0.0	0.0	78.3	76.3	-1.8	0.0	0.0	0.0	0.0	-0.0	-82.9	-82.9
8	500498.10	5442057.81	2.60	0	8000	77.7	77.7	0.0	0.0	78.3	272.1	-1.8	0.0	0.0	0.0	0.0	-0.0	-271.0	-271.0

Point Source, ISO 9613, Name: "Em_Inv8", ID: "Em_Inv8"																			
Nr.	X	Y	Z	Refl.	Freq.	LxT	LxN	K0	Dc	Adiv	Aatm	Agr	Afol	Ahous	Abar	Cmet	RL	LrT	LrN
	(m)	(m)	(m)		(Hz)	dB(A)	dB(A)	(dB)	(dB)	(dB)	(dB)	(dB)	(dB)	(dB)	(dB)	(dB)	(dB)	dB(A)	dB(A)
1	500461.90	5442281.81	2.60	0	63	68.1	68.1	0.0	0.0	77.9	0.3	-5.8	0.0	0.0	0.0	0.0	-0.0	-4.2	-4.2
2	500461.90	5442281.81	2.60	0	125	78.9	78.9	0.0	0.0	77.9	0.9	5.2	0.0	0.0	0.0	0.0	-0.0	-5.1	-5.1
3	500461.90	5442281.81	2.60	0	250	85.5	85.5	0.0	0.0	77.9	2.3	6.4	0.0	0.0	0.0	0.0	-0.0	-1.1	-1.1
4	500461.90	5442281.81	2.60	0	500	87.3	87.3	0.0	0.0	77.9	4.3	2.2	0.0	0.0	0.0	0.0	-0.0	3.0	3.0
5	500461.90	5442281.81	2.60	0	1000	83.7	83.7	0.0	0.0	77.9	8.1	-1.3	0.0	0.0	0.0	0.0	-0.0	-1.0	-1.0
6	500461.90	5442281.81	2.60	0	2000	79.1	79.1	0.0	0.0	77.9	21.3	-1.8	0.0	0.0	0.0	0.0	-0.0	-18.4	-18.4
7	500461.90	5442281.81	2.60	0	4000	70.0	70.0	0.0	0.0	77.9	72.4	-1.8	0.0	0.0	0.0	0.0	-0.0	-78.5	-78.5
8	500461.90	5442281.81	2.60	0	8000	77.7	77.7	0.0	0.0	77.9	258.1	-1.8	0.0	0.0	0.0	0.0	-0.0	-256.5	-256.5

Point Source, ISO 9613, Name: "Em_Inv9", ID: "Em_Inv9"																			
Nr.	X	Y	Z	Refl.	Freq.	LxT	LxN	K0	Dc	Adiv	Aatm	Agr	Afol	Ahous	Abar	Cmet	RL	LrT	LrN
	(m)	(m)	(m)		(Hz)	dB(A)	dB(A)	(dB)	(dB)	(dB)	(dB)	(dB)	(dB)	(dB)	(dB)	(dB)	(dB)	dB(A)	dB(A)
1	500651.93	5442280.81	2.60	0	63	68.1	68.1	0.0	0.0	77.3	0.3	-5.8	0.0	0.0	0.0	0.0	-0.0	-3.6	-3.6
2	500651.93	5442280.81	2.60	0	125	78.9	78.9	0.0	0.0	77.3	0.9	5.2	0.0	0.0	0.0	0.0	-0.0	-4.5	-4.5
3	500651.93	5442280.81	2.60	0	250	85.5	85.5	0.0	0.0	77.3	2.1	6.5	0.0	0.0	0.0	0.0	-0.0	-0.4	-0.4
4	500651.93	5442280.81	2.60	0	500	87.3	87.3	0.0	0.0	77.3	4.0	2.2	0.0	0.0	0.0	0.0	-0.0	3.9	3.9
5	500651.93	5442280.81	2.60	0	1000	83.7	83.7	0.0	0.0	77.3	7.5	-1.3	0.0	0.0	0.0	0.0	-0.0	0.1	0.1
6	500651.93	5442280.81	2.60	0	2000	79.1	79.1	0.0	0.0	77.3	19.9	-1.8	0.0	0.0	0.0	0.0	-0.0	-16.4	-16.4
7	500651.93	5442280.81	2.60	0	4000	70.0	70.0	0.0	0.0	77.3	67.6	-1.8	0.0	0.0	0.0	0.0	-0.0	-73.2	-73.2
8	500651.93	5442280.81	2.60	0	8000	77.7	77.7	0.0	0.0	77.3	241.2	-1.8	0.0	0.0	0.0	0.0	-0.0	-239.1	-239.1

Point Source, ISO 9613, Name: "Em_Inv10", ID: "Em_Inv10"																			
Nr.	X	Y	Z	Refl.	Freq.	LxT	LxN	K0	Dc	Adiv	Aatm	Agr	Afol	Ahous	Abar	Cmet	RL	LrT	LrN
	(m)	(m)	(m)		(Hz)	dB(A)	dB(A)	(dB)	(dB)	(dB)	(dB)	(dB)	(dB)	(dB)	(dB)	(dB)	(dB)	dB(A)	dB(A)
1	499992.71	5441665.81	2.60	0	63	68.1	68.1	0.0	0.0	80.4	0.4	-5.9	0.0	0.0	0.0	0.0	-0.0	-6.8	-6.8
2	499992.71	5441665.81	2.60	0	125	78.9	78.9	0.0	0.0	80.4	1.2	5.2	0.0	0.0	0.0	0.0	-0.0	-8.0	-8.0
3	499992.71	5441665.81	2.60	0	250	85.5	85.5	0.0	0.0	80.4	3.1	6.4	0.0	0.0	0.0	0.0	-0.0	-4.5	-4.5
4	499992.71	5441665.81	2.60	0	500	87.3	87.3	0.0	0.0	80.4	5.7	2.2	0.0	0.0	0.0	0.0	-0.0	-1.0	-1.0
5	499992.71	5441665.81	2.60	0	1000	83.7	83.7	0.0	0.0	80.4	10.9	-1.3	0.0	0.0	0.0	0.0	-0.0	-6.3	-6.3
6	499992.71	5441665.81	2.60	0	2000	79.1	79.1	0.0	0.0	80.4	28.7	-1.8	0.0	0.0	0.0	0.0	-0.0	-28.2	-28.2
7	499992.71	5441665.81	2.60	0	4000	70.0	70.0	0.0	0.0	80.4	97.2	-1.8	0.0	0.0	0.0	0.0	-0.0	-105.8	-105.8
8	499992.71	5441665.81	2.60	0	8000	77.7	77.7	0.0	0.0	80.4	346.6	-1.8	0.0	0.0	0.0	0.0	-0.0	-347.6	-347.6

Point Source, ISO 9613, Name: "Em_Trans1", ID: "Em_Trans1"																			
Nr.	X	Y	Z	Refl.	Freq.	LxT	LxN	K0	Dc	Adiv	Aatm	Agr	Afol	Ahous	Abar	Cmet	RL	LrT	LrN
	(m)	(m)	(m)		(Hz)	dB(A)	dB(A)	(dB)	(dB)	(dB)	(dB)	(dB)	(dB)	(dB)	(dB)	(dB)	(dB)	dB(A)	dB(A)
1	500755.03	5441418.91	2.58	0	32	37.3	37.3	0.0	0.0	79.5	0.1	-5.9	0.0	0.0	0.0	0.0	-0.0	-36.4	-36.4
2	500755.03	5441418.91	2.58	0	63	56.5	56.5	0.0	0.0	79.5	0.3	-5.9	0.0	0.0	0.0	0.0	-0.0	-17.5	-17.5
3	500755.03	5441418.91	2.58	0	125	68.6	68.6	0.0	0.0	79.5	1.1	5.2	0.0	0.0	0.0	0.0	-0.0	-17.2	-17.2
4	500755.03	5441418.91	2.58	0	250	71.1	71.1	0.0	0.0	79.5	2.8	6.5	0.0	0.0	0.0	0.0	-0.0	-17.6	-17.6
5	500755.03	5441418.91	2.58	0	500	76.5	76.5	0.0	0.0	79.5	5.1	2.2	0.0	0.0	0.0	0.0	-0.0	-10.3	-10.3
6	500755.03	5441418.91	2.58	0	1000	73.7	73.7	0.0	0.0	79.5	9.7	-1.3	0.0	0.0	0.0	0.0	-0.0	-14.2	-14.2
7	500755.03	5441418.91	2.58	0	2000	69.9	69.9	0.0	0.0	79.5	25.7	-1.8	0.0	0.0	0.0	0.0	-0.0	-33.5	-33.5
8	500755.03	5441418.91	2.58	0	4000	64.7	64.7	0.0	0.0	79.5	87.2	-1.8	0.0	0.0	0.0	0.0	-0.0	-100.2	-100.2
9	500755.03	5441418.91	2.58	0	8000	55.6	55.6	0.0	0.0	79.5	310.9	-1.8	0.0	0.0	0.0	0.0	-0.0	-333.0	-333.0

Point Source, ISO 9613, Name: "Em_Trans2", ID: "Em_Trans2"																			
Nr.	X	Y	Z	Refl.	Freq.	LxT	LxN	K0	Dc	Adiv	Aatm	Agr	Afol	Ahous	Abar	Cmet	RL	LrT	LrN
	(m)	(m)	(m)		(Hz)	dB(A)	dB(A)	(dB)	(dB)	(dB)	(dB)	(dB)	(dB)	(dB)	(dB)	(dB)	(dB)	dB(A)	dB(A)
1	500557.90	5441519.71	2.58	0	32	37.3	37.3	0.0	0.0	79.6	0.1	-5.9	0.0	0.0	0.0	0.0	-0.0	-36.5	-36.5
2	500557.90	5441519.71	2.58	0	63	56.5	56.5	0.0	0.0	79.6	0.3	-5.9	0.0	0.0	0.0	0.0	-0.0	-17.6	-17.6
3	500557.90	5441519.71	2.58	0	125	68.6	68.6	0.0	0.0	79.6	1.1	5.2	0.0	0.0	0.0	0.0	-0.0	-17.3	-17.3
4	500557.90	5441519.71	2.58	0	250	71.1	71.1	0.0	0.0	79.6	2.8	6.5	0.0	0.0	0.0	0.0	-0.0	-17.8	-17.8
5	500557.90	5441519.71	2.58	0	500	76.5	76.5	0.0	0.0	79.6	5.2	2.2	0.0	0.0	0.0	0.0	-0.0	-10.5	-10.5
6	500557.90	5441519.71	2.58	0	1000	73.7	73.7	0.0	0.0	79.6	9.8	-1.3	0.0	0.0	0.0	0.0	-0.0	-14.5	-14.5
7	500557.90	5441519.71	2.58	0	2000	69.9	69.9	0.0	0.0	79.6	26.0	-1.8	0.0	0.0	0.0	0.0	-0.0	-33.9	-33.9
8	500557.90	5441519.71	2.58	0	4000	64.7	64.7	0.0	0.0	79.6	88.2	-1.8	0.0	0.0	0.0	0.0	-0.0	-101.3	-101.3
9	500557.90	5441519.71	2.58	0	8000	55.6	55.6	0.0	0.0	79.6	314.4	-1.8	0.0	0.0	0.0	0.0	-0.0	-336.7	-336.7

Point Source, ISO 9613, Name: "Em_Trans3", ID: "Em_Trans3"																			
Nr.	X	Y	Z	Refl.	Freq.	LxT	LxN	K0	Dc	Adiv	Aatm	Agr	Afol	Ahous	Abar	Cmet	RL	LrT	LrN
	(m)	(m)	(m)		(Hz)	dB(A)	dB(A)	(dB)	(dB)	(dB)	(dB)	(dB)	(dB)	(dB)	(dB)	(dB)	(dB)	dB(A)	dB(A)
1	500755.03	5441687.71	2.58	0	32	37.3	37.3	0.0	0.0	78.7	0.1	-5.8	0.0	0.0	0.0	0.0	-0.0	-35.7	-35.7
2	500755.03	5441687.71	2.58	0	63	56.5	56.5	0.0	0.0	78.7	0.3	-5.8	0.0	0.0	0.0	0.0	-0.0	-16.7	-16.7
3	500755.03	5441687.71	2.58	0	125	68.6	68.6	0.0	0.0	78.7	1.0	5.2	0.0	0.0	0.0	0.0	-0.0	-16.4	-16.4
4	500755.03	5441687.71	2.58	0	250	71.1	71.1	0.0	0.0	78.7	2.5	6.5	0.0	0.0	0.0	0.0	-0.0	-16.7	-16.7
5	500755.03	5441687.71	2.58	0	500	76.5	76.5	0.0	0.0	78.7	4.7	2.2	0.0	0.0	0.0	0.0	-0.0	-9.1	-9.1
6	500755.03	5441687.71	2.58	0	1000	73.7	73.7	0.0	0.0	78.7	8.9	-1.3	0.0	0.0	0.0	0.0	-0.0	-12.7	-12.7
7	500755.03	5441687.71	2.58	0	2000	69.9	69.9	0.0	0.0	78.7	23.6	-1.8	0.0	0.0	0.0	0.0	-0.0	-30.6	-30.6
8	500755.03	5441687.71	2.58	0	4000	64.7	64.7	0.0	0.0	78.7	79.9	-1.8	0.0	0.0	0.0	0.0	-0.0	-92.2	-92.2
9	500755.03	5441687.71	2.58	0	8000	55.6	55.6	0.0	0.0	78.7	284.9	-1.8	0.0	0.0	0.0	0.0	-0.0	-306.3	-306.3

Point Source, ISO 9613, Name: "Em_Trans4", ID: "Em_Trans4"																			
Nr.	X	Y	Z	Refl.	Freq.	LxT	LxN	K0	Dc	Adiv	Aatm	Agr	Afol	Ahous	Abar	Cmet	RL	LrT	LrN
	(m)	(m)	(m)		(Hz)	dB(A)	dB(A)	(dB)	(dB)	(dB)	(dB)	(dB)	(dB)	(dB)	(dB)	(dB)	(dB)	dB(A)	dB(A)
1	500521.70	5441732.51	2.58	0	32	37.3	37.3	0.0	0.0	79.1	0.1	-5.9	0.0	0.0	0.0	0.0	-0.0	-36.0	-36.0
2	500521.70	5441732.51	2.58	0	63	56.5	56.5	0.0	0.0	79.1	0.3	-5.9	0.0	0.0	0.0	0.0	-0.0	-17.1	-17.1
3	500521.70	5441732.51	2.58	0	125	68.6	68.6	0.0	0.0	79.1	1.1	5.2	0.0	0.0	0.0	0.0	-0.0	-16.8	-16.8
4	500521.70	5441732.51	2.58	0	250	71.1	71.1	0.0	0.0	79.1	2.7	6.5	0.0	0.0	0.0	0.0	-0.0	-17.2	-17.2
5	500521.70	5441732.51	2.58	0	500	76.5	76.5	0.0	0.0	79.1	4.9	2.2	0.0	0.0	0.0	0.0	-0.0	-9.7	-9.7
6	500521.70	5441732.51	2.58	0	1000	73.7	73.7	0.0	0.0	79.1	9.3	-1.3	0.0	0.0	0.0	0.0	-0.0	-13.5	-13.5
7	500521.70	5441732.51	2.58	0	2000	69.9	69.9	0.0	0.0	79.1	24.6	-1.8	0.0	0.0	0.0	0.0	-0.0	-32.1	-32.1
8	500521.70	5441732.51	2.58	0	4000	64.7	64.7	0.0	0.0	79.1	83.5	-1.8	0.0	0.0	0.0	0.0	-0.0	-96.1	-96.1
9	500521.70	5441732.51	2.58	0	8000	55.6	55.6	0.0	0.0	79.1	297.8	-1.8	0.0	0.0	0.0	0.0	-0.0	-319.5	-319.5

Point Source, ISO 9613, Name: "Em_Trans5", ID: "Em_Trans5"																			
Nr.	X	Y	Z	Refl.	Freq.	LxT	LxN	K0	Dc	Adiv	Aatm	Agr	Afol	Ahous	Abar	Cmet	RL	LrT	LrN
	(m)	(m)	(m)		(Hz)	dB(A)	dB(A)	(dB)	(dB)	(dB)	(dB)	(dB)	(dB)	(dB)	(dB)	(dB)	(dB)	dB(A)	dB(A)
1	500755.03	5441956.51	2.58	0	32	37.3	37.3	0.0	0.0	78.0	0.1	-5.8	0.0	0.0	0.0	0.0	-0.0	-34.9	-34.9
2	500755.03	5441956.51	2.58	0	63	56.5	56.5	0.0	0.0	78.0	0.3	-5.8	0.0	0.0	0.0	0.0	-0.0	-15.9	-15.9
3	500755.03	5441956.51	2.58	0	125	68.6	68.6	0.0	0.0	78.0	0.9	5.2	0.0	0.0	0.0	0.0	-0.0	-15.5	-15.5
4	500755.03	5441956.51	2.58	0	250	71.1	71.1	0.0	0.0	78.0	2.3	6.5	0.0	0.0	0.0	0.0	-0.0	-15.6	-15.6
5	500755.03	5441956.51	2.58	0	500	76.5	76.5	0.0	0.0	78.0	4.3	2.2	0.0	0.0	0.0	0.0	-0.0	-7.9	-7.9
6	500755.03	5441956.51	2.58	0	1000	73.7	73.7	0.0	0.0	78.0	8.1	-1.3	0.0	0.0	0.0	0.0	-0.0	-11.1	-11.1
7	500755.03	5441956.51	2.58	0	2000	69.9	69.9	0.0	0.0	78.0	21.5	-1.8	0.0	0.0	0.0	0.0	-0.0	-27.8	-27.8
8	500755.03	5441956.51	2.58	0	4000	64.7	64.7	0.0	0.0	78.0	72.9	-1.8	0.0	0.0	0.0	0.0	-0.0	-84.4	-84.4
9	500755.03	5441956.51	2.58	0	8000	55.6	55.6	0.0	0.0	78.0	260.2	-1.8	0.0	0.0	0.0	0.0	-0.0	-280.8	-280.8

Point Source, ISO 9613, Name: "Em_Trans6", ID: "Em_Trans6"																			
Nr.	X	Y	Z	Refl.	Freq.	LxT	LxN	K0	Dc	Adiv	Aatm	Agr	Afol	Ahous	Abar	Cmet	RL	LrT	LrN
	(m)	(m)	(m)		(Hz)	dB(A)	dB(A)	(dB)	(dB)	(dB)	(dB)	(dB)	(dB)	(dB)	(dB)	(dB)	(dB)	dB(A)	dB(A)
1	500503.60	5441900.51	2.58	0	32	37.3	37.3	0.0	0.0	78.7	0.1	-5.8	0.0	0.0	0.0	0.0	-0.0	-35.7	-35.7
2	500503.60	5441900.51	2.58	0	63	56.5	56.5	0.0	0.0	78.7	0.3	-5.8	0.0	0.0	0.0	0.0	-0.0	-16.7	-16.7
3	500503.60	5441900.51	2.58	0	125	68.6	68.6	0.0	0.0	78.7	1.0	5.2	0.0	0.0	0.0	0.0	-0.0	-16.4	-16.4
4	500503.60	5441900.51	2.58	0	250	71.1	71.1	0.0	0.0	78.7	2.5	6.5	0.0	0.0	0.0	0.0	-0.0	-16.6	-16.6
5	500503.60	5441900.51	2.58	0	500	76.5	76.5	0.0	0.0	78.7	4.7	2.2	0.0	0.0	0.0	0.0	-0.0	-9.1	-9.1
6	500503.60	5441900.51	2.58	0	1000	73.7	73.7	0.0	0.0	78.7	8.9	-1.3	0.0	0.0	0.0	0.0	-0.0	-12.7	-12.7
7	500503.60	5441900.51	2.58	0	2000	69.9	69.9	0.0	0.0	78.7	23.5	-1.8	0.0	0.0	0.0	0.0	-0.0	-30.6	-30.6
8	500503.60	5441900.51	2.58	0	4000	64.7	64.7	0.0	0.0	78.7	79.8	-1.8	0.0	0.0	0.0	0.0	-0.0	-92.1	-92.1
9	500503.60	5441900.51	2.58	0	8000	55.6	55.6	0.0	0.0	78.7	284.7	-1.8	0.0	0.0	0.0	0.0	-0.0	-306.0	-306.0

Point Source, ISO 9613, Name: "Em_Trans7", ID: "Em_Trans7"																			
Nr.	X	Y	Z	Refl.	Freq.	LxT	LxN	K0	Dc	Adiv	Aatm	Agr	Afol	Ahous	Abar	Cmet	RL	LrT	LrN
	(m)	(m)	(m)		(Hz)	dB(A)	dB(A)	(dB)	(dB)	(dB)	(dB)	(dB)	(dB)	(dB)	(dB)	(dB)	(dB)	dB(A)	dB(A)
1	500503.60	5442057.31	2.58	0	32	37.3	37.3	0.0	0.0	78.3	0.1	-5.8	0.0	0.0	0.0	0.0	-0.0	-35.3	-35.3
2	500503.60	5442057.31	2.58	0	63	56.5	56.5	0.0	0.0	78.3	0.3	-5.8	0.0	0.0	0.0	0.0	-0.0	-16.3	-16.3
3	500503.60	5442057.31	2.58	0	125	68.6	68.6	0.0	0.0	78.3	1.0	5.2	0.0	0.0	0.0	0.0	-0.0	-15.9	-15.9
4	500503.60	5442057.31	2.58	0	250	71.1	71.1	0.0	0.0	78.3	2.4	6.5	0.0	0.0	0.0	0.0	-0.0	-16.1	-16.1
5	500503.60	5442057.31	2.58	0	500	76.5	76.5	0.0	0.0	78.3	4.5	2.2	0.0	0.0	0.0	0.0	-0.0	-8.5	-8.5
6	500503.60	5442057.31	2.58	0	1000	73.7	73.7	0.0	0.0	78.3	8.5	-1.3	0.0	0.0	0.0	0.0	-0.0	-11.9	-11.9
7	500503.60	5442057.31	2.58	0	2000	69.9	69.9	0.0	0.0	78.3	22.5	-1.8	0.0	0.0	0.0	0.0	-0.0	-29.1	-29.1
8	500503.60	5442057.31	2.58	0	4000	64.7	64.7	0.0	0.0	78.3	76.2	-1.8	0.0	0.0	0.0	0.0	-0.0	-88.0	-88.0
9	500503.60	5442057.31	2.58	0	8000	55.6	55.6	0.0	0.0	78.3	271.7	-1.8	0.0	0.0	0.0	0.0	-0.0	-292.7	-292.7

Point Source, ISO 9613, Name: "Em_Trans8", ID: "Em_Trans8"																			
Nr.	X	Y	Z	Refl.	Freq.	LxT	LxN	K0	Dc	Adiv	Aatm	Agr	Afol	Ahous	Abar	Cmet	RL	LrT	LrN
	(m)	(m)	(m)		(Hz)	dB(A)	dB(A)	(dB)	(dB)	(dB)	(dB)	(dB)	(dB)	(dB)	(dB)	(dB)	(dB)	dB(A)	dB(A)
1	500467.40	5442281.31	2.58	0	32	37.3	37.3	0.0	0.0	77.9	0.1	-5.8	0.0	0.0	0.0	0.0	-0.0	-34.8	-34.8
2	500467.40	5442281.31	2.58	0	63	56.5	56.5	0.0	0.0	77.9	0.3	-5.8	0.0	0.0	0.0	0.0	-0.0	-15.8	-15.8
3	500467.40	5442281.31	2.58	0	125	68.6	68.6	0.0	0.0	77.9	0.9	5.2	0.0	0.0	0.0	0.0	-0.0	-15.4	-15.4
4	500467.40	5442281.31	2.58	0	250	71.1	71.1	0.0	0.0	77.9	2.3	6.5	0.0	0.0	0.0	0.0	-0.0	-15.5	-15.5
5	500467.40	5442281.31	2.58	0	500	76.5	76.5	0.0	0.0	77.9	4.3	2.2	0.0	0.0	0.0	0.0	-0.0	-7.8	-7.8
6	500467.40	5442281.31	2.58	0	1000	73.7	73.7	0.0	0.0	77.9	8.1	-1.3	0.0	0.0	0.0	0.0	-0.0	-11.0	-11.0
7	500467.40	5442281.31	2.58	0	2000	69.9	69.9	0.0	0.0	77.9	21.3	-1.8	0.0	0.0	0.0	0.0	-0.0	-27.5	-27.5
8	500467.40	5442281.31	2.58	0	4000	64.7	64.7	0.0	0.0	77.9	72.2	-1.8	0.0	0.0	0.0	0.0	-0.0	-83.6	-83.6
9	500467.40	5442281.31	2.58	0	8000	55.6	55.6	0.0	0.0	77.9	257.6	-1.8	0.0	0.0	0.0	0.0	-0.0	-278.2	-278.2

Point Source, ISO 9613, Name: "Em_Trans9", ID: "Em_Trans9"																			
Nr.	X	Y	Z	Refl.	Freq.	LxT	LxN	K0	Dc	Adiv	Aatm	Agr	Afol	Ahous	Abar	Cmet	RL	LrT	LrN
	(m)	(m)	(m)		(Hz)	dB(A)	dB(A)	(dB)	(dB)	(dB)	(dB)	(dB)	(dB)	(dB)	(dB)	(dB)	(dB)	dB(A)	dB(A)
1	500646.43	5442281.31	2.58	0	32	37.3	37.3	0.0	0.0	77.3	0.1	-5.8	0.0	0.0	0.0	0.0	-0.0	-34.3	-34.3
2	500646.43	5442281.31	2.58	0	63	56.5	56.5	0.0	0.0	77.3	0.3	-5.8	0.0	0.0	0.0	0.0	-0.0	-15.2	-15.2
3	500646.43	5442281.31	2.58	0	125	68.6	68.6	0.0	0.0	77.3	0.9	5.2	0.0	0.0	0.0	0.0	-0.0	-14.8	-14.8
4	500646.43	5442281.31	2.58	0	250	71.1	71.1	0.0	0.0	77.3	2.2	6.5	0.0	0.0	0.0	0.0	-0.0	-14.8	-14.8
5	500646.43	5442281.31	2.58	0	500	76.5	76.5	0.0	0.0	77.3	4.0	2.2	0.0	0.0	0.0	0.0	-0.0	-7.0	-7.0
6	500646.43	5442281.31	2.58	0	1000	73.7	73.7	0.0	0.0	77.3	7.6	-1.3	0.0	0.0	0.0	0.0	-0.0	-9.9	-9.9
7	500646.43	5442281.31	2.58	0	2000	69.9	69.9	0.0	0.0	77.3	20.0	-1.8	0.0	0.0	0.0	0.0	-0.0	-25.6	-25.6
8	500646.43	5442281.31	2.58	0	4000	64.7	64.7	0.0	0.0	77.3	67.8	-1.8	0.0	0.0	0.0	0.0	-0.0	-78.6	-78.6
9	500646.43	5442281.31	2.58	0	8000	55.6	55.6	0.0	0.0	77.3	241.7	-1.8	0.0	0.0	0.0	0.0	-0.0	-261.6	-261.6

Point Source, ISO 9613, Name: "Em_Trans10", ID: "Em_Trans10"																			
Nr.	X	Y	Z	Refl.	Freq.	LxT	LxN	K0	Dc	Adiv	Aatm	Agr	Afol	Ahous	Abar	Cmet	RL	LrT	LrN
	(m)	(m)	(m)		(Hz)	dB(A)	dB(A)	(dB)	(dB)	(dB)	(dB)	(dB)	(dB)	(dB)	(dB)	(dB)	(dB)	dB(A)	dB(A)
1	499998.21	5441665.31	2.58	0	32	37.3	37.3	0.0	0.0	80.4	0.1	-5.9	0.0	0.0	0.0	0.0	-0.0	-37.3	-37.3
2	499998.21	5441665.31	2.58	0	63	56.5	56.5	0.0	0.0	80.4	0.4	-5.9	0.0	0.0	0.0	0.0	-0.0	-18.4	-18.4
3	499998.21	5441665.31	2.58	0	125	68.6	68.6	0.0	0.0	80.4	1.2	5.2	0.0	0.0	0.0	0.0	-0.0	-18.3	-18.3
4	499998.21	5441665.31	2.58	0	250	71.1	71.1	0.0	0.0	80.4	3.1	6.5	0.0	0.0	0.0	0.0	-0.0	-18.9	-18.9
5	499998.21	5441665.31	2.58	0	500	76.5	76.5	0.0	0.0	80.4	5.7	2.2	0.0	0.0	0.0	0.0	-0.0	-11.8	-11.8
6	499998.21	5441665.31	2.58	0	1000	73.7	73.7	0.0	0.0	80.4	10.8	-1.3	0.0	0.0	0.0	0.0	-0.0	-16.3	-16.3
7	499998.21	5441665.31	2.58	0	2000	69.9	69.9	0.0	0.0	80.4	28.6	-1.8	0.0	0.0	0.0	0.0	-0.0	-37.4	-37.4
8	499998.21	5441665.31	2.58	0	4000	64.7	64.7	0.0	0.0	80.4	97.0	-1.8	0.0	0.0	0.0	0.0	-0.0	-111.0	-111.0
9	499998.21	5441665.31	2.58	0	8000	55.6	55.6	0.0	0.0	80.4	346.2	-1.8	0.0	0.0	0.0	0.0	-0.0	-369.2	-369.2

Point Source, ISO 9613, Name: "MM_Sub115", ID: "MM_Sub115"																			
Nr.	X	Y	Z	Refl.	Freq.	LxT	LxN	K0	Dc	Adiv	Aatm	Agr	Afol	Ahous	Abar	Cmet	RL	LrT	LrN
	(m)	(m)	(m)		(Hz)	dB(A)	dB(A)	(dB)	(dB)	(dB)	(dB)	(dB)	(dB)	(dB)	(dB)	(dB)	(dB)	dB(A)	dB(A)
1	500993.61	5443521.27	3.60	0	32	43.3	43.3	0.0	0.0	72.6	0.0	-5.6	0.0	0.0	0.0	0.0	-0.0	-23.7	-23.7
2	500993.61	5443521.27	3.60	0	63	60.5	60.5	0.0	0.0	72.6	0.2	-5.6	0.0	0.0	0.0	0.0	-0.0	-6.6	-6.6
3	500993.61	5443521.27	3.60	0	125	73.6	73.6	0.0	0.0	72.6	0.5	4.9	0.0	0.0	0.0	0.0	-0.0	-4.4	-4.4
4	500993.61	5443521.27	3.60	0	250	79.1	79.1	0.0	0.0	72.6	1.3	5.1	0.0	0.0	0.0	0.0	-0.0	0.2	0.2
5	500993.61	5443521.27	3.60	0	500	84.5	84.5	0.0	0.0	72.6	2.3	1.8	0.0	0.0	0.0	0.0	-0.0	7.8	7.8
6	500993.61	5443521.27	3.60	0	1000	81.7	81.7	0.0	0.0	72.6	4.4	-1.2	0.0	0.0	0.0	0.0	-0.0	5.9	5.9
7	500993.61	5443521.27	3.60	0	2000	77.9	77.9	0.0	0.0	72.6	11.6	-1.7	0.0	0.0	0.0	0.0	-0.0	-4.6	-4.6
8	500993.61	5443521.27	3.60	0	4000	72.7	72.7	0.0	0.0	72.6	39.4	-1.7	0.0	0.0	0.0	0.0	-0.0	-37.6	-37.6
9	500993.61	5443521.27	3.60	0	8000	62.6	62.6	0.0	0.0	72.6	140.4	-1.7	0.0	0.0	0.0	0.0	-0.0	-148.7	-148.7

Point Source, ISO 9613, Name: "MM_Inv1", ID: "MM_Inv1"																			
Nr.	X	Y	Z	Refl.	Freq.	LxT	LxN	K0	Dc	Adiv	Aatm	Agr	Afol	Ahous	Abar	Cmet	RL	LrT	LrN
	(m)	(m)	(m)		(Hz)	dB(A)	dB(A)	(dB)	(dB)	(dB)	(dB)	(dB)	(dB)	(dB)	(dB)	(dB)	(dB)	dB(A)	dB(A)
1	501222.00	5443157.66	2.60	0	63	68.1	68.1	0.0	0.0	71.7	0.1	-5.7	0.0	0.0	0.0	0.0	-0.0	1.9	1.9
2	501222.00	5443157.66	2.60	0	125	78.9	78.9	0.0	0.0	71.7	0.5	5.1	0.0	0.0	0.0	0.0	-0.0	1.7	1.7
3	501222.00	5443157.66	2.60	0	250	85.5	85.5	0.0	0.0	71.7	1.1	6.5	0.0	0.0	0.0	0.0	-0.0	6.1	6.1
4	501222.00	5443157.66	2.60	0	500	87.3	87.3	0.0	0.0	71.7	2.1	2.2	0.0	0.0	0.0	0.0	-0.0	11.3	11.3
5	501222.00	5443157.66	2.60	0	1000	83.7	83.7	0.0	0.0	71.7	4.0	-1.2	0.0	0.0	0.0	0.0	-0.0	9.2	9.2
6	501222.00	5443157.66	2.60	0	2000	79.1	79.1	0.0	0.0	71.7	10.5	-1.7	0.0	0.0	0.0	0.0	-0.0	-1.5	-1.5
7	501222.00	5443157.66	2.60	0	4000	70.0	70.0	0.0	0.0	71.7	35.6	-1.7	0.0	0.0	0.0	0.0	-0.0	-35.7	-35.7
8	501222.00	5443157.66	2.60	0	8000	77.7	77.7	0.0	0.0	71.7	127.2	-1.7	0.0	0.0	0.0	0.0	-0.0	-119.5	-119.5

Point Source, ISO 9613, Name: "MM_Inv2", ID: "MM_Inv2"																			
Nr.	X	Y	Z	Refl.	Freq.	LxT	LxN	K0	Dc	Adiv	Aatm	Agr	Afol	Ahous	Abar	Cmet	RL	LrT	LrN
	(m)	(m)	(m)		(Hz)	dB(A)	dB(A)	(dB)	(dB)	(dB)	(dB)	(dB)	(dB)	(dB)	(dB)	(dB)	(dB)	dB(A)	dB(A)
1	501240.10	5442978.46	2.60	0	63	68.1	68.1	0.0	0.0	72.3	0.1	-5.7	0.0	0.0	0.0	0.0	-0.0	1.3	1.3
2	501240.10	5442978.46	2.60	0	125	78.9	78.9	0.0	0.0	72.3	0.5	5.1	0.0	0.0	0.0	0.0	-0.0	0.9	0.9
3	501240.10	5442978.46	2.60	0	250	85.5	85.5	0.0	0.0	72.3	1.2	6.5	0.0	0.0	0.0	0.0	-0.0	5.5	5.5
4	501240.10	5442978.46	2.60	0	500	87.3	87.3	0.0	0.0	72.3	2.3	2.2	0.0	0.0	0.0	0.0	-0.0	10.5	10.5
5	501240.10	5442978.46	2.60	0	1000	83.7	83.7	0.0	0.0	72.3	4.3	-1.2	0.0	0.0	0.0	0.0	-0.0	8.3	8.3
6	501240.10	5442978.46	2.60	0	2000	79.1	79.1	0.0	0.0	72.3	11.3	-1.7	0.0	0.0	0.0	0.0	-0.0	-2.8	-2.8
7	501240.10	5442978.46	2.60	0	4000	70.0	70.0	0.0	0.0	72.3	38.2	-1.7	0.0	0.0	0.0	0.0	-0.0	-38.9	-38.9
8	501240.10	5442978.46	2.60	0	8000	77.7	77.7	0.0	0.0	72.3	136.4	-1.7	0.0	0.0	0.0	0.0	-0.0	-129.3	-129.3

Point Source, ISO 9613, Name: "MM_Inv3", ID: "MM_Inv3"																			
Nr.	X	Y	Z	Refl.	Freq.	LxT	LxN	K0	Dc	Adiv	Aatm	Agr	Afol	Ahous	Abar	Cmet	RL	LrT	LrN
	(m)	(m)	(m)		(Hz)	dB(A)	dB(A)	(dB)	(dB)	(dB)	(dB)	(dB)	(dB)	(dB)	(dB)	(dB)	(dB)	dB(A)	dB(A)
1	501240.10	5442776.86	2.60	0	63	68.1	68.1	0.0	0.0	73.3	0.2	-5.7	0.0	0.0	0.0	0.0	-0.0	0.4	0.4
2	501240.10	5442776.86	2.60	0	125	78.9	78.9	0.0	0.0	73.3	0.5	5.2	0.0	0.0	0.0	0.0	-0.0	-0.1	-0.1
3	501240.10	5442776.86	2.60	0	250	85.5	85.5	0.0	0.0	73.3	1.4	6.5	0.0	0.0	0.0	0.0	-0.0	4.4	4.4
4	501240.10	5442776.86	2.60	0	500	87.3	87.3	0.0	0.0	73.3	2.5	2.2	0.0	0.0	0.0	0.0	-0.0	9.4	9.4
5	501240.10	5442776.86	2.60	0	1000	83.7	83.7	0.0	0.0	73.3	4.7	-1.2	0.0	0.0	0.0	0.0	-0.0	7.0	7.0
6	501240.10	5442776.86	2.60	0	2000	79.1	79.1	0.0	0.0	73.3	12.5	-1.7	0.0	0.0	0.0	0.0	-0.0	-5.0	-5.0
7	501240.10	5442776.86	2.60	0	4000	70.0	70.0	0.0	0.0	73.3	42.4	-1.7	0.0	0.0	0.0	0.0	-0.0	-44.0	-44.0
8	501240.10	5442776.86	2.60	0	8000	77.7	77.7	0.0	0.0	73.3	151.4	-1.7	0.0	0.0	0.0	0.0	-0.0	-145.2	-145.2

Point Source, ISO 9613, Name: "MM_Inv4", ID: "MM_Inv4"																			
Nr.	X	Y	Z	Refl.	Freq.	LxT	LxN	K0	Dc	Adiv	Aatm	Agr	Afol	Ahous	Abar	Cmet	RL	LrT	LrN
	(m)	(m)	(m)		(Hz)	dB(A)	dB(A)	(dB)	(dB)	(dB)	(dB)	(dB)	(dB)	(dB)	(dB)	(dB)	(dB)	dB(A)	dB(A)
1	501240.10	5442575.26	2.60	0	63	68.1	68.1	0.0	0.0	74.2	0.2	-5.7	0.0	0.0	0.0	0.0	-0.0	-0.5	-0.5

Point Source, ISO 9613, Name: "MM_Inv4", ID: "MM_Inv4"																			
Nr.	X	Y	Z	Refl.	Freq.	LxT	LxN	K0	Dc	Adiv	Aatm	Agr	Afol	Ahous	Abar	Cmet	RL	LrT	LrN
	(m)	(m)	(m)		(Hz)	dB(A)	dB(A)	(dB)	(dB)	(dB)	(dB)	(dB)	(dB)	(dB)	(dB)	(dB)	(dB)	dB(A)	dB(A)
2	501240.10	5442575.26	2.60	0	125	78.9	78.9	0.0	0.0	74.2	0.6	5.2	0.0	0.0	0.0	0.0	-0.0	-1.1	-1.1
3	501240.10	5442575.26	2.60	0	250	85.5	85.5	0.0	0.0	74.2	1.5	6.5	0.0	0.0	0.0	0.0	-0.0	3.4	3.4
4	501240.10	5442575.26	2.60	0	500	87.3	87.3	0.0	0.0	74.2	2.8	2.2	0.0	0.0	0.0	0.0	-0.0	8.2	8.2
5	501240.10	5442575.26	2.60	0	1000	83.7	83.7	0.0	0.0	74.2	5.3	-1.3	0.0	0.0	0.0	0.0	-0.0	5.5	5.5
6	501240.10	5442575.26	2.60	0	2000	79.1	79.1	0.0	0.0	74.2	13.9	-1.7	0.0	0.0	0.0	0.0	-0.0	-7.3	-7.3
7	501240.10	5442575.26	2.60	0	4000	70.0	70.0	0.0	0.0	74.2	47.2	-1.7	0.0	0.0	0.0	0.0	-0.0	-49.6	-49.6
8	501240.10	5442575.26	2.60	0	8000	77.7	77.7	0.0	0.0	74.2	168.3	-1.7	0.0	0.0	0.0	0.0	-0.0	-163.1	-163.1

Point Source, ISO 9613, Name: "MM_Inv5", ID: "MM_Inv5"																			
Nr.	X	Y	Z	Refl.	Freq.	LxT	LxN	K0	Dc	Adiv	Aatm	Agr	Afol	Ahous	Abar	Cmet	RL	LrT	LrN
	(m)	(m)	(m)		(Hz)	dB(A)	dB(A)	(dB)	(dB)	(dB)	(dB)	(dB)	(dB)	(dB)	(dB)	(dB)	(dB)	dB(A)	dB(A)
1	500977.67	5442553.91	2.60	0	63	68.1	68.1	0.0	0.0	75.3	0.2	-5.8	0.0	0.0	0.0	0.0	-0.0	-1.6	-1.6
2	500977.67	5442553.91	2.60	0	125	78.9	78.9	0.0	0.0	75.3	0.7	5.2	0.0	0.0	0.0	0.0	-0.0	-2.3	-2.3
3	500977.67	5442553.91	2.60	0	250	85.5	85.5	0.0	0.0	75.3	1.7	6.5	0.0	0.0	0.0	0.0	-0.0	2.0	2.0
4	500977.67	5442553.91	2.60	0	500	87.3	87.3	0.0	0.0	75.3	3.2	2.2	0.0	0.0	0.0	0.0	-0.0	6.7	6.7
5	500977.67	5442553.91	2.60	0	1000	83.7	83.7	0.0	0.0	75.3	6.0	-1.3	0.0	0.0	0.0	0.0	-0.0	3.7	3.7
6	500977.67	5442553.91	2.60	0	2000	79.1	79.1	0.0	0.0	75.3	15.8	-1.7	0.0	0.0	0.0	0.0	-0.0	-10.3	-10.3
7	500977.67	5442553.91	2.60	0	4000	70.0	70.0	0.0	0.0	75.3	53.7	-1.7	0.0	0.0	0.0	0.0	-0.0	-57.3	-57.3
8	500977.67	5442553.91	2.60	0	8000	77.7	77.7	0.0	0.0	75.3	191.6	-1.7	0.0	0.0	0.0	0.0	-0.0	-187.4	-187.4

Point Source, ISO 9613, Name: "MM_Inv6", ID: "MM_Inv6"																			
Nr.	X	Y	Z	Refl.	Freq.	LxT	LxN	K0	Dc	Adiv	Aatm	Agr	Afol	Ahous	Abar	Cmet	RL	LrT	LrN
	(m)	(m)	(m)		(Hz)	dB(A)	dB(A)	(dB)	(dB)	(dB)	(dB)	(dB)	(dB)	(dB)	(dB)	(dB)	(dB)	dB(A)	dB(A)
1	500977.67	5442755.51	2.60	0	63	68.1	68.1	0.0	0.0	74.6	0.2	-5.8	0.0	0.0	0.0	0.0	-0.0	-0.9	-0.9
2	500977.67	5442755.51	2.60	0	125	78.9	78.9	0.0	0.0	74.6	0.6	5.2	0.0	0.0	0.0	0.0	-0.0	-1.5	-1.5
3	500977.67	5442755.51	2.60	0	250	85.5	85.5	0.0	0.0	74.6	1.6	6.5	0.0	0.0	0.0	0.0	-0.0	2.9	2.9
4	500977.67	5442755.51	2.60	0	500	87.3	87.3	0.0	0.0	74.6	2.9	2.2	0.0	0.0	0.0	0.0	-0.0	7.6	7.6
5	500977.67	5442755.51	2.60	0	1000	83.7	83.7	0.0	0.0	74.6	5.5	-1.3	0.0	0.0	0.0	0.0	-0.0	4.8	4.8
6	500977.67	5442755.51	2.60	0	2000	79.1	79.1	0.0	0.0	74.6	14.6	-1.7	0.0	0.0	0.0	0.0	-0.0	-8.4	-8.4
7	500977.67	5442755.51	2.60	0	4000	70.0	70.0	0.0	0.0	74.6	49.5	-1.7	0.0	0.0	0.0	0.0	-0.0	-52.3	-52.3
8	500977.67	5442755.51	2.60	0	8000	77.7	77.7	0.0	0.0	74.6	176.5	-1.7	0.0	0.0	0.0	0.0	-0.0	-171.7	-171.7

Point Source, ISO 9613, Name: "MM_Inv7", ID: "MM_Inv7"																			
Nr.	X	Y	Z	Refl.	Freq.	LxT	LxN	K0	Dc	Adiv	Aatm	Agr	Afol	Ahous	Abar	Cmet	RL	LrT	LrN
	(m)	(m)	(m)		(Hz)	dB(A)	dB(A)	(dB)	(dB)	(dB)	(dB)	(dB)	(dB)	(dB)	(dB)	(dB)	(dB)	dB(A)	dB(A)
1	500977.67	5442957.06	2.60	0	63	68.1	68.1	0.0	0.0	73.9	0.2	-5.7	0.0	0.0	0.0	0.0	-0.0	-0.3	-0.3
2	500977.67	5442957.06	2.60	0	125	78.9	78.9	0.0	0.0	73.9	0.6	5.2	0.0	0.0	0.0	0.0	-0.0	-0.8	-0.8
3	500977.67	5442957.06	2.60	0	250	85.5	85.5	0.0	0.0	73.9	1.5	6.5	0.0	0.0	0.0	0.0	-0.0	3.6	3.6
4	500977.67	5442957.06	2.60	0	500	87.3	87.3	0.0	0.0	73.9	2.7	2.2	0.0	0.0	0.0	0.0	-0.0	8.5	8.5
5	500977.67	5442957.06	2.60	0	1000	83.7	83.7	0.0	0.0	73.9	5.1	-1.3	0.0	0.0	0.0	0.0	-0.0	5.9	5.9
6	500977.67	5442957.06	2.60	0	2000	79.1	79.1	0.0	0.0	73.9	13.5	-1.7	0.0	0.0	0.0	0.0	-0.0	-6.6	-6.6
7	500977.67	5442957.06	2.60	0	4000	70.0	70.0	0.0	0.0	73.9	45.8	-1.7	0.0	0.0	0.0	0.0	-0.0	-48.0	-48.0
8	500977.67	5442957.06	2.60	0	8000	77.7	77.7	0.0	0.0	73.9	163.5	-1.7	0.0	0.0	0.0	0.0	-0.0	-158.0	-158.0

Point Source, ISO 9613, Name: "MM_Trans1", ID: "MM_Trans1"																			
Nr.	X	Y	Z	Refl.	Freq.	LxT	LxN	K0	Dc	Adiv	Aatm	Agr	Afol	Ahous	Abar	Cmet	RL	LrT	LrN
	(m)	(m)	(m)		(Hz)	dB(A)	dB(A)	(dB)	(dB)	(dB)	(dB)	(dB)	(dB)	(dB)	(dB)	(dB)	(dB)	dB(A)	dB(A)
1	501216.50	5443158.16	2.58	0	32	37.3	37.3	0.0	0.0	71.8	0.0	-5.7	0.0	0.0	0.0	0.0	-0.0	-28.8	-28.8
2	501216.50	5443158.16	2.58	0	63	56.5	56.5	0.0	0.0	71.8	0.1	-5.7	0.0	0.0	0.0	0.0	-0.0	-9.7	-9.7
3	501216.50	5443158.16	2.58	0	125	68.6	68.6	0.0	0.0	71.8	0.5	5.1	0.0	0.0	0.0	0.0	-0.0	-8.7	-8.7
4	501216.50	5443158.16	2.58	0	250	71.1	71.1	0.0	0.0	71.8	1.1	6.5	0.0	0.0	0.0	0.0	-0.0	-8.3	-8.3
5	501216.50	5443158.16	2.58	0	500	76.5	76.5	0.0	0.0	71.8	2.1	2.2	0.0	0.0	0.0	0.0	-0.0	0.4	0.4
6	501216.50	5443158.16	2.58	0	1000	73.7	73.7	0.0	0.0	71.8	4.0	-1.2	0.0	0.0	0.0	0.0	-0.0	-0.8	-0.8
7	501216.50	5443158.16	2.58	0	2000	69.9	69.9	0.0	0.0	71.8	10.6	-1.7	0.0	0.0	0.0	0.0	-0.0	-10.7	-10.7
8	501216.50	5443158.16	2.58	0	4000	64.7	64.7	0.0	0.0	71.8	35.8	-1.7	0.0	0.0	0.0	0.0	-0.0	-41.2	-41.2
9	501216.50	5443158.16	2.58	0	8000	55.6	55.6	0.0	0.0	71.8	127.7	-1.7	0.0	0.0	0.0	0.0	-0.0	-142.2	-142.2

Point Source, ISO 9613, Name: "MM_Trans2", ID: "MM_Trans2"																			
Nr.	X	Y	Z	Refl.	Freq.	LxT	LxN	K0	Dc	Adiv	Aatm	Agr	Afol	Ahous	Abar	Cmet	RL	LrT	LrN
	(m)	(m)	(m)		(Hz)	dB(A)	dB(A)	(dB)	(dB)	(dB)	(dB)	(dB)	(dB)	(dB)	(dB)	(dB)	(dB)	dB(A)	dB(A)
1	501234.60	5442978.96	2.58	0	32	37.3	37.3	0.0	0.0	72.4	0.0	-5.7	0.0	0.0	0.0	0.0	-0.0	-29.4	-29.4
2	501234.60	5442978.96	2.58	0	63	56.5	56.5	0.0	0.0	72.4	0.1	-5.7	0.0	0.0	0.0	0.0	-0.0	-10.3	-10.3
3	501234.60	5442978.96	2.58	0	125	68.6	68.6	0.0	0.0	72.4	0.5	5.1	0.0	0.0	0.0	0.0	-0.0	-9.4	-9.4

Point Source, ISO 9613, Name: "MM_Trans2", ID: "MM_Trans2"																			
Nr.	X	Y	Z	Refl.	Freq.	LxT	LxN	K0	Dc	Adiv	Aatm	Agr	Afol	Ahous	Abar	Cmet	RL	LrT	LrN
	(m)	(m)	(m)		(Hz)	dB(A)	dB(A)	(dB)	(dB)	(dB)	(dB)	(dB)	(dB)	(dB)	(dB)	(dB)	(dB)	dB(A)	dB(A)
4	501234.60	5442978.96	2.58	0	250	71.1	71.1	0.0	0.0	72.4	1.2	6.5	0.0	0.0	0.0	0.0	-0.0	-9.0	-9.0
5	501234.60	5442978.96	2.58	0	500	76.5	76.5	0.0	0.0	72.4	2.3	2.2	0.0	0.0	0.0	0.0	-0.0	-0.4	-0.4
6	501234.60	5442978.96	2.58	0	1000	73.7	73.7	0.0	0.0	72.4	4.3	-1.2	0.0	0.0	0.0	0.0	-0.0	-1.7	-1.7
7	501234.60	5442978.96	2.58	0	2000	69.9	69.9	0.0	0.0	72.4	11.3	-1.7	0.0	0.0	0.0	0.0	-0.0	-12.1	-12.1
8	501234.60	5442978.96	2.58	0	4000	64.7	64.7	0.0	0.0	72.4	38.4	-1.7	0.0	0.0	0.0	0.0	-0.0	-44.3	-44.3
9	501234.60	5442978.96	2.58	0	8000	55.6	55.6	0.0	0.0	72.4	136.9	-1.7	0.0	0.0	0.0	0.0	-0.0	-151.9	-151.9

Point Source, ISO 9613, Name: "MM_Trans3", ID: "MM_Trans3"																			
Nr.	X	Y	Z	Refl.	Freq.	LxT	LxN	K0	Dc	Adiv	Aatm	Agr	Afol	Ahous	Abar	Cmet	RL	LrT	LrN
	(m)	(m)	(m)		(Hz)	dB(A)	dB(A)	(dB)	(dB)	(dB)	(dB)	(dB)	(dB)	(dB)	(dB)	(dB)	(dB)	dB(A)	dB(A)
1	501234.60	5442777.36	2.58	0	32	37.3	37.3	0.0	0.0	73.3	0.0	-5.7	0.0	0.0	0.0	0.0	-0.0	-30.3	-30.3
2	501234.60	5442777.36	2.58	0	63	56.5	56.5	0.0	0.0	73.3	0.2	-5.7	0.0	0.0	0.0	0.0	-0.0	-11.2	-11.2
3	501234.60	5442777.36	2.58	0	125	68.6	68.6	0.0	0.0	73.3	0.5	5.2	0.0	0.0	0.0	0.0	-0.0	-10.4	-10.4
4	501234.60	5442777.36	2.58	0	250	71.1	71.1	0.0	0.0	73.3	1.4	6.5	0.0	0.0	0.0	0.0	-0.0	-10.0	-10.0
5	501234.60	5442777.36	2.58	0	500	76.5	76.5	0.0	0.0	73.3	2.5	2.2	0.0	0.0	0.0	0.0	-0.0	-1.5	-1.5
6	501234.60	5442777.36	2.58	0	1000	73.7	73.7	0.0	0.0	73.3	4.8	-1.2	0.0	0.0	0.0	0.0	-0.0	-3.1	-3.1
7	501234.60	5442777.36	2.58	0	2000	69.9	69.9	0.0	0.0	73.3	12.6	-1.7	0.0	0.0	0.0	0.0	-0.0	-14.2	-14.2
8	501234.60	5442777.36	2.58	0	4000	64.7	64.7	0.0	0.0	73.3	42.6	-1.7	0.0	0.0	0.0	0.0	-0.0	-49.4	-49.4
9	501234.60	5442777.36	2.58	0	8000	55.6	55.6	0.0	0.0	73.3	151.8	-1.7	0.0	0.0	0.0	0.0	-0.0	-167.8	-167.8

Point Source, ISO 9613, Name: "MM_Trans4", ID: "MM_Trans4"																			
Nr.	X	Y	Z	Refl.	Freq.	LxT	LxN	K0	Dc	Adiv	Aatm	Agr	Afol	Ahous	Abar	Cmet	RL	LrT	LrN
	(m)	(m)	(m)		(Hz)	dB(A)	dB(A)	(dB)	(dB)	(dB)	(dB)	(dB)	(dB)	(dB)	(dB)	(dB)	(dB)	dB(A)	dB(A)
1	501234.60	5442575.76	2.58	0	32	37.3	37.3	0.0	0.0	74.2	0.1	-5.8	0.0	0.0	0.0	0.0	-0.0	-31.2	-31.2
2	501234.60	5442575.76	2.58	0	63	56.5	56.5	0.0	0.0	74.2	0.2	-5.8	0.0	0.0	0.0	0.0	-0.0	-12.1	-12.1
3	501234.60	5442575.76	2.58	0	125	68.6	68.6	0.0	0.0	74.2	0.6	5.2	0.0	0.0	0.0	0.0	-0.0	-11.4	-11.4
4	501234.60	5442575.76	2.58	0	250	71.1	71.1	0.0	0.0	74.2	1.5	6.5	0.0	0.0	0.0	0.0	-0.0	-11.1	-11.1
5	501234.60	5442575.76	2.58	0	500	76.5	76.5	0.0	0.0	74.2	2.8	2.2	0.0	0.0	0.0	0.0	-0.0	-2.7	-2.7
6	501234.60	5442575.76	2.58	0	1000	73.7	73.7	0.0	0.0	74.2	5.3	-1.3	0.0	0.0	0.0	0.0	-0.0	-4.5	-4.5
7	501234.60	5442575.76	2.58	0	2000	69.9	69.9	0.0	0.0	74.2	14.0	-1.7	0.0	0.0	0.0	0.0	-0.0	-16.5	-16.5
8	501234.60	5442575.76	2.58	0	4000	64.7	64.7	0.0	0.0	74.2	47.3	-1.7	0.0	0.0	0.0	0.0	-0.0	-55.1	-55.1
9	501234.60	5442575.76	2.58	0	8000	55.6	55.6	0.0	0.0	74.2	168.7	-1.7	0.0	0.0	0.0	0.0	-0.0	-185.6	-185.6

Point Source, ISO 9613, Name: "MM_Trans5", ID: "MM_Trans5"																			
Nr.	X	Y	Z	Refl.	Freq.	LxT	LxN	K0	Dc	Adiv	Aatm	Agr	Afol	Ahous	Abar	Cmet	RL	LrT	LrN
	(m)	(m)	(m)		(Hz)	dB(A)	dB(A)	(dB)	(dB)	(dB)	(dB)	(dB)	(dB)	(dB)	(dB)	(dB)	(dB)	dB(A)	dB(A)
1	500983.17	5442553.41	2.58	0	32	37.3	37.3	0.0	0.0	75.3	0.1	-5.8	0.0	0.0	0.0	0.0	-0.0	-32.3	-32.3
2	500983.17	5442553.41	2.58	0	63	56.5	56.5	0.0	0.0	75.3	0.2	-5.8	0.0	0.0	0.0	0.0	-0.0	-13.2	-13.2
3	500983.17	5442553.41	2.58	0	125	68.6	68.6	0.0	0.0	75.3	0.7	5.2	0.0	0.0	0.0	0.0	-0.0	-12.6	-12.6
4	500983.17	5442553.41	2.58	0	250	71.1	71.1	0.0	0.0	75.3	1.7	6.5	0.0	0.0	0.0	0.0	-0.0	-12.4	-12.4
5	500983.17	5442553.41	2.58	0	500	76.5	76.5	0.0	0.0	75.3	3.1	2.2	0.0	0.0	0.0	0.0	-0.0	-4.1	-4.1
6	500983.17	5442553.41	2.58	0	1000	73.7	73.7	0.0	0.0	75.3	6.0	-1.3	0.0	0.0	0.0	0.0	-0.0	-6.3	-6.3
7	500983.17	5442553.41	2.58	0	2000	69.9	69.9	0.0	0.0	75.3	15.8	-1.7	0.0	0.0	0.0	0.0	-0.0	-19.4	-19.4
8	500983.17	5442553.41	2.58	0	4000	64.7	64.7	0.0	0.0	75.3	53.6	-1.7	0.0	0.0	0.0	0.0	-0.0	-62.4	-62.4
9	500983.17	5442553.41	2.58	0	8000	55.6	55.6	0.0	0.0	75.3	191.2	-1.7	0.0	0.0	0.0	0.0	-0.0	-209.1	-209.1

Point Source, ISO 9613, Name: "MM_Trans6", ID: "MM_Trans6"																			
Nr.	X	Y	Z	Refl.	Freq.	LxT	LxN	K0	Dc	Adiv	Aatm	Agr	Afol	Ahous	Abar	Cmet	RL	LrT	LrN
	(m)	(m)	(m)		(Hz)	dB(A)	dB(A)	(dB)	(dB)	(dB)	(dB)	(dB)	(dB)	(dB)	(dB)	(dB)	(dB)	dB(A)	dB(A)
1	500983.17	5442755.01	2.58	0	32	37.3	37.3	0.0	0.0	74.6	0.1	-5.8	0.0	0.0	0.0	0.0	-0.0	-31.6	-31.6
2	500983.17	5442755.01	2.58	0	63	56.5	56.5	0.0	0.0	74.6	0.2	-5.8	0.0	0.0	0.0	0.0	-0.0	-12.5	-12.5
3	500983.17	5442755.01	2.58	0	125	68.6	68.6	0.0	0.0	74.6	0.6	5.2	0.0	0.0	0.0	0.0	-0.0	-11.8	-11.8
4	500983.17	5442755.01	2.58	0	250	71.1	71.1	0.0	0.0	74.6	1.6	6.5	0.0	0.0	0.0	0.0	-0.0	-11.5	-11.5
5	500983.17	5442755.01	2.58	0	500	76.5	76.5	0.0	0.0	74.6	2.9	2.2	0.0	0.0	0.0	0.0	-0.0	-3.2	-3.2
6	500983.17	5442755.01	2.58	0	1000	73.7	73.7	0.0	0.0	74.6	5.5	-1.3	0.0	0.0	0.0	0.0	-0.0	-5.1	-5.1
7	500983.17	5442755.01	2.58	0	2000	69.9	69.9	0.0	0.0	74.6	14.6	-1.7	0.0	0.0	0.0	0.0	-0.0	-17.5	-17.5
8	500983.17	5442755.01	2.58	0	4000	64.7	64.7	0.0	0.0	74.6	49.4	-1.7	0.0	0.0	0.0	0.0	-0.0	-57.5	-57.5
9	500983.17	5442755.01	2.58	0	8000	55.6	55.6	0.0	0.0	74.6	176.1	-1.7	0.0	0.0	0.0	0.0	-0.0	-193.3	-193.3

Point Source, ISO 9613, Name: "MM_Trans7", ID: "MM_Trans7"																			
Nr.	X	Y	Z	Refl.	Freq.	LxT	LxN	K0	Dc	Adiv	Aatm	Agr	Afol	Ahous	Abar	Cmet	RL	LrT	LrN
	(m)	(m)	(m)		(Hz)	dB(A)	dB(A)	(dB)	(dB)	(dB)	(dB)	(dB)	(dB)	(dB)	(dB)	(dB)	(dB)	dB(A)	dB(A)
1	500983.17	5442956.56	2.58	0	32	37.3	37.3	0.0	0.0	73.9	0.0	-5.7	0.0	0.0	0.0	0.0	-0.0	-30.9	-30.9

Point Source, ISO 9613, Name: "MM_Trans7", ID: "MM_Trans7"																			
Nr.	X	Y	Z	Refl.	Freq.	LxT	LxN	K0	Dc	Adiv	Aatm	Agr	Afol	Ahous	Abar	Cmet	RL	LrT	LrN
	(m)	(m)	(m)		(Hz)	dB(A)	dB(A)	(dB)	(dB)	(dB)	(dB)	(dB)	(dB)	(dB)	(dB)	(dB)	(dB)	dB(A)	dB(A)
2	500983.17	5442956.56	2.58	0	63	56.5	56.5	0.0	0.0	73.9	0.2	-5.7	0.0	0.0	0.0	0.0	-0.0	-11.8	-11.8
3	500983.17	5442956.56	2.58	0	125	68.6	68.6	0.0	0.0	73.9	0.6	5.2	0.0	0.0	0.0	0.0	-0.0	-11.1	-11.1
4	500983.17	5442956.56	2.58	0	250	71.1	71.1	0.0	0.0	73.9	1.5	6.5	0.0	0.0	0.0	0.0	-0.0	-10.7	-10.7
5	500983.17	5442956.56	2.58	0	500	76.5	76.5	0.0	0.0	73.9	2.7	2.2	0.0	0.0	0.0	0.0	-0.0	-2.3	-2.3
6	500983.17	5442956.56	2.58	0	1000	73.7	73.7	0.0	0.0	73.9	5.1	-1.3	0.0	0.0	0.0	0.0	-0.0	-4.0	-4.0
7	500983.17	5442956.56	2.58	0	2000	69.9	69.9	0.0	0.0	73.9	13.5	-1.7	0.0	0.0	0.0	0.0	-0.0	-15.7	-15.7
8	500983.17	5442956.56	2.58	0	4000	64.7	64.7	0.0	0.0	73.9	45.7	-1.7	0.0	0.0	0.0	0.0	-0.0	-53.2	-53.2
9	500983.17	5442956.56	2.58	0	8000	55.6	55.6	0.0	0.0	73.9	163.0	-1.7	0.0	0.0	0.0	0.0	-0.0	-179.6	-179.6

Receiver

Name: 45_R36

ID: 45_R36

X: 501060.44

Y: 5443682.05

Z: 4.50

Point Source, ISO 9613, Name: "Ab_Sub115", ID: "Ab_Sub115"

Nr.	X (m)	Y (m)	Z (m)	Refl.	Freq. (Hz)	LxT dB(A)	LxN dB(A)	K0 (dB)	Dc (dB)	Adiv (dB)	Aatm (dB)	Agr (dB)	Afol (dB)	Ahous (dB)	Abar (dB)	Cmet (dB)	RL (dB)	LrT dB(A)	LrN dB(A)
1	501008.63	5443536.29	3.60	0	32	43.3	43.3	0.0	0.0	54.8	0.0	-3.0	0.0	0.0	0.0	0.0	-0.0	-8.5	-8.5
2	501008.63	5443536.29	3.60	0	63	60.5	60.5	0.0	0.0	54.8	0.0	-3.0	0.0	0.0	0.0	0.0	-0.0	8.7	8.7
3	501008.63	5443536.29	3.60	0	125	73.6	73.6	0.0	0.0	54.8	0.1	2.8	0.0	0.0	0.0	0.0	-0.0	16.0	16.0
4	501008.63	5443536.29	3.60	0	250	79.1	79.1	0.0	0.0	54.8	0.2	1.8	0.0	0.0	0.0	0.0	-0.0	22.3	22.3
5	501008.63	5443536.29	3.60	0	500	84.5	84.5	0.0	0.0	54.8	0.3	-0.9	0.0	0.0	0.0	0.0	-0.0	30.3	30.3
6	501008.63	5443536.29	3.60	0	1000	81.7	81.7	0.0	0.0	54.8	0.6	-0.9	0.0	0.0	0.0	0.0	-0.0	27.2	27.2
7	501008.63	5443536.29	3.60	0	2000	77.9	77.9	0.0	0.0	54.8	1.5	-0.9	0.0	0.0	0.0	0.0	-0.0	22.5	22.5
8	501008.63	5443536.29	3.60	0	4000	72.7	72.7	0.0	0.0	54.8	5.1	-0.9	0.0	0.0	0.0	0.0	-0.0	13.7	13.7
9	501008.63	5443536.29	3.60	0	8000	62.6	62.6	0.0	0.0	54.8	18.1	-0.9	0.0	0.0	0.0	0.0	-0.0	-9.4	-9.4

Point Source, ISO 9613, Name: "Ab_Inv1", ID: "Ab_Inv1"

Nr.	X (m)	Y (m)	Z (m)	Refl.	Freq. (Hz)	LxT dB(A)	LxN dB(A)	K0 (dB)	Dc (dB)	Adiv (dB)	Aatm (dB)	Agr (dB)	Afol (dB)	Ahous (dB)	Abar (dB)	Cmet (dB)	RL (dB)	LrT dB(A)	LrN dB(A)
1	501813.68	5442663.24	2.60	0	63	68.1	68.1	0.0	0.0	73.1	0.2	-5.5	0.0	0.0	0.0	0.0	-0.0	0.4	0.4
2	501813.68	5442663.24	2.60	0	125	78.9	78.9	0.0	0.0	73.1	0.5	4.2	0.0	0.0	0.0	0.0	-0.0	1.1	1.1
3	501813.68	5442663.24	2.60	0	250	85.5	85.5	0.0	0.0	73.1	1.3	2.6	0.0	0.0	0.0	0.0	-0.0	8.5	8.5
4	501813.68	5442663.24	2.60	0	500	87.3	87.3	0.0	0.0	73.1	2.4	-1.2	0.0	0.0	0.0	0.0	-0.0	13.0	13.0
5	501813.68	5442663.24	2.60	0	1000	83.7	83.7	0.0	0.0	73.1	4.6	-1.6	0.0	0.0	0.0	0.0	-0.0	7.6	7.6
6	501813.68	5442663.24	2.60	0	2000	79.1	79.1	0.0	0.0	73.1	12.2	-1.7	0.0	0.0	0.0	0.0	-0.0	-4.5	-4.5
7	501813.68	5442663.24	2.60	0	4000	70.0	70.0	0.0	0.0	73.1	41.5	-1.7	0.0	0.0	0.0	0.0	-0.0	-42.9	-42.9
8	501813.68	5442663.24	2.60	0	8000	77.7	77.7	0.0	0.0	73.1	148.1	-1.7	0.0	0.0	0.0	0.0	-0.0	-141.8	-141.8

Point Source, ISO 9613, Name: "Ab_Inv2", ID: "Ab_Inv2"

Nr.	X (m)	Y (m)	Z (m)	Refl.	Freq. (Hz)	LxT dB(A)	LxN dB(A)	K0 (dB)	Dc (dB)	Adiv (dB)	Aatm (dB)	Agr (dB)	Afol (dB)	Ahous (dB)	Abar (dB)	Cmet (dB)	RL (dB)	LrT dB(A)	LrN dB(A)
1	501813.68	5442842.44	2.60	0	63	68.1	68.1	0.0	0.0	72.0	0.1	-5.4	0.0	0.0	0.0	0.0	-0.0	1.4	1.4
2	501813.68	5442842.44	2.60	0	125	78.9	78.9	0.0	0.0	72.0	0.5	4.2	0.0	0.0	0.0	0.0	-0.0	2.2	2.2
3	501813.68	5442842.44	2.60	0	250	85.5	85.5	0.0	0.0	72.0	1.2	2.6	0.0	0.0	0.0	0.0	-0.0	9.7	9.7
4	501813.68	5442842.44	2.60	0	500	87.3	87.3	0.0	0.0	72.0	2.2	-1.2	0.0	0.0	0.0	0.0	-0.0	14.3	14.3
5	501813.68	5442842.44	2.60	0	1000	83.7	83.7	0.0	0.0	72.0	4.1	-1.6	0.0	0.0	0.0	0.0	-0.0	9.2	9.2
6	501813.68	5442842.44	2.60	0	2000	79.1	79.1	0.0	0.0	72.0	10.9	-1.6	0.0	0.0	0.0	0.0	-0.0	-2.2	-2.2
7	501813.68	5442842.44	2.60	0	4000	70.0	70.0	0.0	0.0	72.0	37.0	-1.6	0.0	0.0	0.0	0.0	-0.0	-37.4	-37.4
8	501813.68	5442842.44	2.60	0	8000	77.7	77.7	0.0	0.0	72.0	131.8	-1.6	0.0	0.0	0.0	0.0	-0.0	-124.6	-124.6

Point Source, ISO 9613, Name: "Ab_Inv3", ID: "Ab_Inv3"

Nr.	X (m)	Y (m)	Z (m)	Refl.	Freq. (Hz)	LxT dB(A)	LxN dB(A)	K0 (dB)	Dc (dB)	Adiv (dB)	Aatm (dB)	Agr (dB)	Afol (dB)	Ahous (dB)	Abar (dB)	Cmet (dB)	RL (dB)	LrT dB(A)	LrN dB(A)
1	501813.58	5443021.64	2.60	0	63	68.1	68.1	0.0	0.0	71.0	0.1	-5.4	0.0	0.0	0.0	0.0	-0.0	2.3	2.3
2	501813.58	5443021.64	2.60	0	125	78.9	78.9	0.0	0.0	71.0	0.4	4.1	0.0	0.0	0.0	0.0	-0.0	3.3	3.3
3	501813.58	5443021.64	2.60	0	250	85.5	85.5	0.0	0.0	71.0	1.1	2.6	0.0	0.0	0.0	0.0	-0.0	10.8	10.8
4	501813.58	5443021.64	2.60	0	500	87.3	87.3	0.0	0.0	71.0	1.9	-1.2	0.0	0.0	0.0	0.0	-0.0	15.5	15.5
5	501813.58	5443021.64	2.60	0	1000	83.7	83.7	0.0	0.0	71.0	3.7	-1.6	0.0	0.0	0.0	0.0	-0.0	10.6	10.6
6	501813.58	5443021.64	2.60	0	2000	79.1	79.1	0.0	0.0	71.0	9.7	-1.6	0.0	0.0	0.0	0.0	-0.0	0.0	0.0
7	501813.58	5443021.64	2.60	0	4000	70.0	70.0	0.0	0.0	71.0	32.8	-1.6	0.0	0.0	0.0	0.0	-0.0	-32.2	-32.2
8	501813.58	5443021.64	2.60	0	8000	77.7	77.7	0.0	0.0	71.0	117.1	-1.6	0.0	0.0	0.0	0.0	-0.0	-108.8	-108.8

Point Source, ISO 9613, Name: "Ab_Inv4", ID: "Ab_Inv4"

Nr.	X (m)	Y (m)	Z (m)	Refl.	Freq. (Hz)	LxT dB(A)	LxN dB(A)	K0 (dB)	Dc (dB)	Adiv (dB)	Aatm (dB)	Agr (dB)	Afol (dB)	Ahous (dB)	Abar (dB)	Cmet (dB)	RL (dB)	LrT dB(A)	LrN dB(A)
1	501813.68	5443200.84	2.60	0	63	68.1	68.1	0.0	0.0	70.0	0.1	-5.3	0.0	0.0	0.0	0.0	-0.0	3.3	3.3
2	501813.68	5443200.84	2.60	0	125	78.9	78.9	0.0	0.0	70.0	0.4	4.0	0.0	0.0	0.0	0.0	-0.0	4.5	4.5
3	501813.68	5443200.84	2.60	0	250	85.5	85.5	0.0	0.0	70.0	0.9	2.7	0.0	0.0	0.0	0.0	-0.0	11.9	11.9
4	501813.68	5443200.84	2.60	0	500	87.3	87.3	0.0	0.0	70.0	1.7	-1.2	0.0	0.0	0.0	0.0	-0.0	16.7	16.7

Point Source, ISO 9613, Name: "Ab_Inv4", ID: "Ab_Inv4"																			
Nr.	X	Y	Z	Refl.	Freq.	LxT	LxN	K0	Dc	Adiv	Aatm	Agr	Afol	Ahous	Abar	Cmet	RL	LrT	LrN
	(m)	(m)	(m)		(Hz)	dB(A)	dB(A)	(dB)	(dB)	(dB)	(dB)	(dB)	(dB)	(dB)	(dB)	(dB)	(dB)	dB(A)	dB(A)
5	501813.68	5443200.84	2.60	0	1000	83.7	83.7	0.0	0.0	70.0	3.3	-1.6	0.0	0.0	0.0	0.0	-0.0	12.0	12.0
6	501813.68	5443200.84	2.60	0	2000	79.1	79.1	0.0	0.0	70.0	8.6	-1.6	0.0	0.0	0.0	0.0	-0.0	2.0	2.0
7	501813.68	5443200.84	2.60	0	4000	70.0	70.0	0.0	0.0	70.0	29.3	-1.6	0.0	0.0	0.0	0.0	-0.0	-27.7	-27.7
8	501813.68	5443200.84	2.60	0	8000	77.7	77.7	0.0	0.0	70.0	104.5	-1.6	0.0	0.0	0.0	0.0	-0.0	-95.2	-95.2

Point Source, ISO 9613, Name: "Ab_Inv5", ID: "Ab_Inv5"																			
Nr.	X	Y	Z	Refl.	Freq.	LxT	LxN	K0	Dc	Adiv	Aatm	Agr	Afol	Ahous	Abar	Cmet	RL	LrT	LrN
	(m)	(m)	(m)		(Hz)	dB(A)	dB(A)	(dB)	(dB)	(dB)	(dB)	(dB)	(dB)	(dB)	(dB)	(dB)	(dB)	dB(A)	dB(A)
1	502235.01	5442875.04	2.60	0	63	68.1	68.1	0.0	0.0	74.1	0.2	-5.5	0.0	0.0	0.0	0.0	-0.0	-0.6	-0.6
2	502235.01	5442875.04	2.60	0	125	78.9	78.9	0.0	0.0	74.1	0.6	4.2	0.0	0.0	0.0	0.0	-0.0	0.0	0.0
3	502235.01	5442875.04	2.60	0	250	85.5	85.5	0.0	0.0	74.1	1.5	2.6	0.0	0.0	0.0	0.0	-0.0	7.3	7.3
4	502235.01	5442875.04	2.60	0	500	87.3	87.3	0.0	0.0	74.1	2.8	-1.2	0.0	0.0	0.0	0.0	-0.0	11.7	11.7
5	502235.01	5442875.04	2.60	0	1000	83.7	83.7	0.0	0.0	74.1	5.2	-1.7	0.0	0.0	0.0	0.0	-0.0	6.1	6.1
6	502235.01	5442875.04	2.60	0	2000	79.1	79.1	0.0	0.0	74.1	13.8	-1.7	0.0	0.0	0.0	0.0	-0.0	-7.1	-7.1
7	502235.01	5442875.04	2.60	0	4000	70.0	70.0	0.0	0.0	74.1	46.7	-1.7	0.0	0.0	0.0	0.0	-0.0	-49.1	-49.1
8	502235.01	5442875.04	2.60	0	8000	77.7	77.7	0.0	0.0	74.1	166.6	-1.7	0.0	0.0	0.0	0.0	-0.0	-161.3	-161.3

Point Source, ISO 9613, Name: "Ab_Inv6", ID: "Ab_Inv6"																			
Nr.	X	Y	Z	Refl.	Freq.	LxT	LxN	K0	Dc	Adiv	Aatm	Agr	Afol	Ahous	Abar	Cmet	RL	LrT	LrN
	(m)	(m)	(m)		(Hz)	dB(A)	dB(A)	(dB)	(dB)	(dB)	(dB)	(dB)	(dB)	(dB)	(dB)	(dB)	(dB)	dB(A)	dB(A)
1	502235.01	5443065.44	2.60	0	63	68.1	68.1	0.0	0.0	73.5	0.2	-5.5	0.0	0.0	0.0	0.0	-0.0	0.0	0.0
2	502235.01	5443065.44	2.60	0	125	78.9	78.9	0.0	0.0	73.5	0.6	4.2	0.0	0.0	0.0	0.0	-0.0	0.7	0.7
3	502235.01	5443065.44	2.60	0	250	85.5	85.5	0.0	0.0	73.5	1.4	2.6	0.0	0.0	0.0	0.0	-0.0	8.1	8.1
4	502235.01	5443065.44	2.60	0	500	87.3	87.3	0.0	0.0	73.5	2.6	-1.2	0.0	0.0	0.0	0.0	-0.0	12.5	12.5
5	502235.01	5443065.44	2.60	0	1000	83.7	83.7	0.0	0.0	73.5	4.8	-1.7	0.0	0.0	0.0	0.0	-0.0	7.0	7.0
6	502235.01	5443065.44	2.60	0	2000	79.1	79.1	0.0	0.0	73.5	12.8	-1.7	0.0	0.0	0.0	0.0	-0.0	-5.5	-5.5
7	502235.01	5443065.44	2.60	0	4000	70.0	70.0	0.0	0.0	73.5	43.5	-1.7	0.0	0.0	0.0	0.0	-0.0	-45.3	-45.3
8	502235.01	5443065.44	2.60	0	8000	77.7	77.7	0.0	0.0	73.5	155.1	-1.7	0.0	0.0	0.0	0.0	-0.0	-149.2	-149.2

Point Source, ISO 9613, Name: "Ab_Inv7", ID: "Ab_Inv7"																			
Nr.	X	Y	Z	Refl.	Freq.	LxT	LxN	K0	Dc	Adiv	Aatm	Agr	Afol	Ahous	Abar	Cmet	RL	LrT	LrN
	(m)	(m)	(m)		(Hz)	dB(A)	dB(A)	(dB)	(dB)	(dB)	(dB)	(dB)	(dB)	(dB)	(dB)	(dB)	(dB)	dB(A)	dB(A)
1	502235.01	5443257.84	2.60	0	63	68.1	68.1	0.0	0.0	72.9	0.2	-5.5	0.0	0.0	0.0	0.0	-0.0	0.5	0.5
2	502235.01	5443257.84	2.60	0	125	78.9	78.9	0.0	0.0	72.9	0.5	4.2	0.0	0.0	0.0	0.0	-0.0	1.2	1.2
3	502235.01	5443257.84	2.60	0	250	85.5	85.5	0.0	0.0	72.9	1.3	2.6	0.0	0.0	0.0	0.0	-0.0	8.7	8.7
4	502235.01	5443257.84	2.60	0	500	87.3	87.3	0.0	0.0	72.9	2.4	-1.2	0.0	0.0	0.0	0.0	-0.0	13.2	13.2
5	502235.01	5443257.84	2.60	0	1000	83.7	83.7	0.0	0.0	72.9	4.6	-1.6	0.0	0.0	0.0	0.0	-0.0	7.8	7.8
6	502235.01	5443257.84	2.60	0	2000	79.1	79.1	0.0	0.0	72.9	12.1	-1.7	0.0	0.0	0.0	0.0	-0.0	-4.3	-4.3
7	502235.01	5443257.84	2.60	0	4000	70.0	70.0	0.0	0.0	72.9	40.9	-1.7	0.0	0.0	0.0	0.0	-0.0	-42.2	-42.2
8	502235.01	5443257.84	2.60	0	8000	77.7	77.7	0.0	0.0	72.9	146.0	-1.7	0.0	0.0	0.0	0.0	-0.0	-139.6	-139.6

Point Source, ISO 9613, Name: "Ab_Trans1", ID: "Ab_Trans1"																			
Nr.	X	Y	Z	Refl.	Freq.	LxT	LxN	K0	Dc	Adiv	Aatm	Agr	Afol	Ahous	Abar	Cmet	RL	LrT	LrN
	(m)	(m)	(m)		(Hz)	dB(A)	dB(A)	(dB)	(dB)	(dB)	(dB)	(dB)	(dB)	(dB)	(dB)	(dB)	(dB)	dB(A)	dB(A)
1	501819.18	5442662.74	2.58	0	32	37.3	37.3	0.0	0.0	73.1	0.0	-5.5	0.0	0.0	0.0	0.0	-0.0	-30.3	-30.3
2	501819.18	5442662.74	2.58	0	63	56.5	56.5	0.0	0.0	73.1	0.2	-5.5	0.0	0.0	0.0	0.0	-0.0	-11.2	-11.2
3	501819.18	5442662.74	2.58	0	125	68.6	68.6	0.0	0.0	73.1	0.5	4.2	0.0	0.0	0.0	0.0	-0.0	-9.2	-9.2
4	501819.18	5442662.74	2.58	0	250	71.1	71.1	0.0	0.0	73.1	1.3	2.6	0.0	0.0	0.0	0.0	-0.0	-5.9	-5.9
5	501819.18	5442662.74	2.58	0	500	76.5	76.5	0.0	0.0	73.1	2.4	-1.2	0.0	0.0	0.0	0.0	-0.0	2.2	2.2
6	501819.18	5442662.74	2.58	0	1000	73.7	73.7	0.0	0.0	73.1	4.6	-1.6	0.0	0.0	0.0	0.0	-0.0	-2.4	-2.4
7	501819.18	5442662.74	2.58	0	2000	69.9	69.9	0.0	0.0	73.1	12.3	-1.7	0.0	0.0	0.0	0.0	-0.0	-13.8	-13.8
8	501819.18	5442662.74	2.58	0	4000	64.7	64.7	0.0	0.0	73.1	41.6	-1.7	0.0	0.0	0.0	0.0	-0.0	-48.4	-48.4
9	501819.18	5442662.74	2.58	0	8000	55.6	55.6	0.0	0.0	73.1	148.5	-1.7	0.0	0.0	0.0	0.0	-0.0	-164.4	-164.4

Point Source, ISO 9613, Name: "Ab_Trans2", ID: "Ab_Trans2"																			
Nr.	X	Y	Z	Refl.	Freq.	LxT	LxN	K0	Dc	Adiv	Aatm	Agr	Afol	Ahous	Abar	Cmet	RL	LrT	LrN
	(m)	(m)	(m)		(Hz)	dB(A)	dB(A)	(dB)	(dB)	(dB)	(dB)	(dB)	(dB)	(dB)	(dB)	(dB)	(dB)	dB(A)	dB(A)
1	501819.18	5442841.94	2.58	0	32	37.3	37.3	0.0	0.0	72.1	0.0	-5.4	0.0	0.0	0.0	0.0	-0.0	-29.4	-29.4
2	501819.18	5442841.94	2.58	0	63	56.5	56.5	0.0	0.0	72.1	0.1	-5.4	0.0	0.0	0.0	0.0	-0.0	-10.3	-10.3
3	501819.18	5442841.94	2.58	0	125	68.6	68.6	0.0	0.0	72.1	0.5	4.2	0.0	0.0	0.0	0.0	-0.0	-8.2	-8.2
4	501819.18	5442841.94	2.58	0	250	71.1	71.1	0.0	0.0	72.1	1.2	2.6	0.0	0.0	0.0	0.0	-0.0	-4.8	-4.8
5	501819.18	5442841.94	2.58	0	500	76.5	76.5	0.0	0.0	72.1	2.2	-1.2	0.0	0.0	0.0	0.0	-0.0	3.4	3.4
6	501819.18	5442841.94	2.58	0	1000	73.7	73.7	0.0	0.0	72.1	4.1	-1.6	0.0	0.0	0.0	0.0	-0.0	-0.9	-0.9

Point Source, ISO 9613, Name: "Ab_Trans2", ID: "Ab_Trans2"																			
Nr.	X	Y	Z	Refl.	Freq.	LxT	LxN	K0	Dc	Adiv	Aatm	Agr	Afol	Ahous	Abar	Cmet	RL	LrT	LrN
	(m)	(m)	(m)		(Hz)	dB(A)	dB(A)	(dB)	(dB)	(dB)	(dB)	(dB)	(dB)	(dB)	(dB)	(dB)	(dB)	dB(A)	dB(A)
7	501819.18	5442841.94	2.58	0	2000	69.9	69.9	0.0	0.0	72.1	10.9	-1.6	0.0	0.0	0.0	0.0	-0.0	-11.5	-11.5
8	501819.18	5442841.94	2.58	0	4000	64.7	64.7	0.0	0.0	72.1	37.1	-1.6	0.0	0.0	0.0	0.0	-0.0	-42.8	-42.8
9	501819.18	5442841.94	2.58	0	8000	55.6	55.6	0.0	0.0	72.1	132.3	-1.6	0.0	0.0	0.0	0.0	-0.0	-147.2	-147.2

Point Source, ISO 9613, Name: "Ab_Trans3", ID: "Ab_Trans3"																			
Nr.	X	Y	Z	Refl.	Freq.	LxT	LxN	K0	Dc	Adiv	Aatm	Agr	Afol	Ahous	Abar	Cmet	RL	LrT	LrN
	(m)	(m)	(m)		(Hz)	dB(A)	dB(A)	(dB)	(dB)	(dB)	(dB)	(dB)	(dB)	(dB)	(dB)	(dB)	(dB)	dB(A)	dB(A)
1	501819.08	5443021.14	2.58	0	32	37.3	37.3	0.0	0.0	71.0	0.0	-5.4	0.0	0.0	0.0	0.0	-0.0	-28.4	-28.4
2	501819.08	5443021.14	2.58	0	63	56.5	56.5	0.0	0.0	71.0	0.1	-5.4	0.0	0.0	0.0	0.0	-0.0	-9.3	-9.3
3	501819.08	5443021.14	2.58	0	125	68.6	68.6	0.0	0.0	71.0	0.4	4.1	0.0	0.0	0.0	0.0	-0.0	-7.0	-7.0
4	501819.08	5443021.14	2.58	0	250	71.1	71.1	0.0	0.0	71.0	1.1	2.7	0.0	0.0	0.0	0.0	-0.0	-3.7	-3.7
5	501819.08	5443021.14	2.58	0	500	76.5	76.5	0.0	0.0	71.0	1.9	-1.2	0.0	0.0	0.0	0.0	-0.0	4.7	4.7
6	501819.08	5443021.14	2.58	0	1000	73.7	73.7	0.0	0.0	71.0	3.7	-1.6	0.0	0.0	0.0	0.0	-0.0	0.6	0.6
7	501819.08	5443021.14	2.58	0	2000	69.9	69.9	0.0	0.0	71.0	9.7	-1.6	0.0	0.0	0.0	0.0	-0.0	-9.3	-9.3
8	501819.08	5443021.14	2.58	0	4000	64.7	64.7	0.0	0.0	71.0	33.0	-1.6	0.0	0.0	0.0	0.0	-0.0	-37.7	-37.7
9	501819.08	5443021.14	2.58	0	8000	55.6	55.6	0.0	0.0	71.0	117.6	-1.6	0.0	0.0	0.0	0.0	-0.0	-131.4	-131.4

Point Source, ISO 9613, Name: "Ab_Trans4", ID: "Ab_Trans4"																			
Nr.	X	Y	Z	Refl.	Freq.	LxT	LxN	K0	Dc	Adiv	Aatm	Agr	Afol	Ahous	Abar	Cmet	RL	LrT	LrN
	(m)	(m)	(m)		(Hz)	dB(A)	dB(A)	(dB)	(dB)	(dB)	(dB)	(dB)	(dB)	(dB)	(dB)	(dB)	(dB)	dB(A)	dB(A)
1	501819.18	5443200.34	2.58	0	32	37.3	37.3	0.0	0.0	70.1	0.0	-5.3	0.0	0.0	0.0	0.0	-0.0	-27.5	-27.5
2	501819.18	5443200.34	2.58	0	63	56.5	56.5	0.0	0.0	70.1	0.1	-5.3	0.0	0.0	0.0	0.0	-0.0	-8.4	-8.4
3	501819.18	5443200.34	2.58	0	125	68.6	68.6	0.0	0.0	70.1	0.4	4.0	0.0	0.0	0.0	0.0	-0.0	-5.9	-5.9
4	501819.18	5443200.34	2.58	0	250	71.1	71.1	0.0	0.0	70.1	0.9	2.7	0.0	0.0	0.0	0.0	-0.0	-2.6	-2.6
5	501819.18	5443200.34	2.58	0	500	76.5	76.5	0.0	0.0	70.1	1.7	-1.1	0.0	0.0	0.0	0.0	-0.0	5.8	5.8
6	501819.18	5443200.34	2.58	0	1000	73.7	73.7	0.0	0.0	70.1	3.3	-1.6	0.0	0.0	0.0	0.0	-0.0	1.9	1.9
7	501819.18	5443200.34	2.58	0	2000	69.9	69.9	0.0	0.0	70.1	8.7	-1.6	0.0	0.0	0.0	0.0	-0.0	-7.3	-7.3
8	501819.18	5443200.34	2.58	0	4000	64.7	64.7	0.0	0.0	70.1	29.4	-1.6	0.0	0.0	0.0	0.0	-0.0	-33.2	-33.2
9	501819.18	5443200.34	2.58	0	8000	55.6	55.6	0.0	0.0	70.1	105.1	-1.6	0.0	0.0	0.0	0.0	-0.0	-117.9	-117.9

Point Source, ISO 9613, Name: "Ab_Trans5", ID: "Ab_Trans5"																			
Nr.	X	Y	Z	Refl.	Freq.	LxT	LxN	K0	Dc	Adiv	Aatm	Agr	Afol	Ahous	Abar	Cmet	RL	LrT	LrN
	(m)	(m)	(m)		(Hz)	dB(A)	dB(A)	(dB)	(dB)	(dB)	(dB)	(dB)	(dB)	(dB)	(dB)	(dB)	(dB)	dB(A)	dB(A)
1	502229.51	5442875.54	2.58	0	32	37.3	37.3	0.0	0.0	74.0	0.1	-5.5	0.0	0.0	0.0	0.0	-0.0	-31.2	-31.2
2	502229.51	5442875.54	2.58	0	63	56.5	56.5	0.0	0.0	74.0	0.2	-5.5	0.0	0.0	0.0	0.0	-0.0	-12.2	-12.2
3	502229.51	5442875.54	2.58	0	125	68.6	68.6	0.0	0.0	74.0	0.6	4.2	0.0	0.0	0.0	0.0	-0.0	-10.3	-10.3
4	502229.51	5442875.54	2.58	0	250	71.1	71.1	0.0	0.0	74.0	1.5	2.6	0.0	0.0	0.0	0.0	-0.0	-7.0	-7.0
5	502229.51	5442875.54	2.58	0	500	76.5	76.5	0.0	0.0	74.0	2.7	-1.2	0.0	0.0	0.0	0.0	-0.0	0.9	0.9
6	502229.51	5442875.54	2.58	0	1000	73.7	73.7	0.0	0.0	74.0	5.2	-1.7	0.0	0.0	0.0	0.0	-0.0	-3.9	-3.9
7	502229.51	5442875.54	2.58	0	2000	69.9	69.9	0.0	0.0	74.0	13.7	-1.7	0.0	0.0	0.0	0.0	-0.0	-16.2	-16.2
8	502229.51	5442875.54	2.58	0	4000	64.7	64.7	0.0	0.0	74.0	46.5	-1.7	0.0	0.0	0.0	0.0	-0.0	-54.2	-54.2
9	502229.51	5442875.54	2.58	0	8000	55.6	55.6	0.0	0.0	74.0	166.0	-1.7	0.0	0.0	0.0	0.0	-0.0	-182.8	-182.8

Point Source, ISO 9613, Name: "Ab_Trans6", ID: "Ab_Trans6"																			
Nr.	X	Y	Z	Refl.	Freq.	LxT	LxN	K0	Dc	Adiv	Aatm	Agr	Afol	Ahous	Abar	Cmet	RL	LrT	LrN
	(m)	(m)	(m)		(Hz)	dB(A)	dB(A)	(dB)	(dB)	(dB)	(dB)	(dB)	(dB)	(dB)	(dB)	(dB)	(dB)	dB(A)	dB(A)
1	502229.51	5443065.94	2.58	0	32	37.3	37.3	0.0	0.0	73.4	0.0	-5.5	0.0	0.0	0.0	0.0	-0.0	-30.7	-30.7
2	502229.51	5443065.94	2.58	0	63	56.5	56.5	0.0	0.0	73.4	0.2	-5.5	0.0	0.0	0.0	0.0	-0.0	-11.6	-11.6
3	502229.51	5443065.94	2.58	0	125	68.6	68.6	0.0	0.0	73.4	0.5	4.2	0.0	0.0	0.0	0.0	-0.0	-9.6	-9.6
4	502229.51	5443065.94	2.58	0	250	71.1	71.1	0.0	0.0	73.4	1.4	2.6	0.0	0.0	0.0	0.0	-0.0	-6.3	-6.3
5	502229.51	5443065.94	2.58	0	500	76.5	76.5	0.0	0.0	73.4	2.5	-1.2	0.0	0.0	0.0	0.0	-0.0	1.7	1.7
6	502229.51	5443065.94	2.58	0	1000	73.7	73.7	0.0	0.0	73.4	4.8	-1.7	0.0	0.0	0.0	0.0	-0.0	-2.9	-2.9
7	502229.51	5443065.94	2.58	0	2000	69.9	69.9	0.0	0.0	73.4	12.8	-1.7	0.0	0.0	0.0	0.0	-0.0	-14.6	-14.6
8	502229.51	5443065.94	2.58	0	4000	64.7	64.7	0.0	0.0	73.4	43.3	-1.7	0.0	0.0	0.0	0.0	-0.0	-50.4	-50.4
9	502229.51	5443065.94	2.58	0	8000	55.6	55.6	0.0	0.0	73.4	154.5	-1.7	0.0	0.0	0.0	0.0	-0.0	-170.6	-170.6

Point Source, ISO 9613, Name: "Ab_Trans7", ID: "Ab_Trans7"																			
Nr.	X	Y	Z	Refl.	Freq.	LxT	LxN	K0	Dc	Adiv	Aatm	Agr	Afol	Ahous	Abar	Cmet	RL	LrT	LrN
	(m)	(m)	(m)		(Hz)	dB(A)	dB(A)	(dB)	(dB)	(dB)	(dB)	(dB)	(dB)	(dB)	(dB)	(dB)	(dB)	dB(A)	dB(A)
1	502229.51	5443258.34	2.58	0	32	37.3	37.3	0.0	0.0	72.9	0.0	-5.5	0.0	0.0	0.0	0.0	-0.0	-30.2	-30.2
2	502229.51	5443258.34	2.58	0	63	56.5	56.5	0.0	0.0	72.9	0.2	-5.5	0.0	0.0	0.0	0.0	-0.0	-11.1	-11.1
3	502229.51	5443258.34	2.58	0	125	68.6	68.6	0.0	0.0	72.9	0.5	4.2	0.0	0.0	0.0	0.0	-0.0	-9.0	-9.0
4	502229.51	5443258.34	2.58	0	250	71.1	71.1	0.0	0.0	72.9	1.3	2.6	0.0	0.0	0.0	0.0	-0.0	-5.7	-5.7

Point Source, ISO 9613, Name: "Ab_Trans7", ID: "Ab_Trans7"																			
Nr.	X	Y	Z	Refl.	Freq.	LxT	LxN	K0	Dc	Adiv	Aatm	Agr	Afol	Ahous	Abar	Cmet	RL	LrT	LrN
	(m)	(m)	(m)		(Hz)	dB(A)	dB(A)	(dB)	(dB)	(dB)	(dB)	(dB)	(dB)	(dB)	(dB)	(dB)	(dB)	dB(A)	dB(A)
5	502229.51	5443258.34	2.58	0	500	76.5	76.5	0.0	0.0	72.9	2.4	-1.2	0.0	0.0	0.0	0.0	-0.0	2.4	2.4
6	502229.51	5443258.34	2.58	0	1000	73.7	73.7	0.0	0.0	72.9	4.5	-1.6	0.0	0.0	0.0	0.0	-0.0	-2.1	-2.1
7	502229.51	5443258.34	2.58	0	2000	69.9	69.9	0.0	0.0	72.9	12.0	-1.7	0.0	0.0	0.0	0.0	-0.0	-13.4	-13.4
8	502229.51	5443258.34	2.58	0	4000	64.7	64.7	0.0	0.0	72.9	40.8	-1.7	0.0	0.0	0.0	0.0	-0.0	-47.3	-47.3
9	502229.51	5443258.34	2.58	0	8000	55.6	55.6	0.0	0.0	72.9	145.3	-1.7	0.0	0.0	0.0	0.0	-0.0	-161.0	-161.0

Point Source, ISO 9613, Name: "Em_Sub115", ID: "Em_Sub115"																			
Nr.	X	Y	Z	Refl.	Freq.	LxT	LxN	K0	Dc	Adiv	Aatm	Agr	Afol	Ahous	Abar	Cmet	RL	LrT	LrN
	(m)	(m)	(m)		(Hz)	dB(A)	dB(A)	(dB)	(dB)	(dB)	(dB)	(dB)	(dB)	(dB)	(dB)	(dB)	(dB)	dB(A)	dB(A)
1	500978.58	5443536.29	3.60	0	32	43.3	43.3	0.0	0.0	55.5	0.0	-3.0	0.0	0.0	0.0	0.0	-0.0	-9.2	-9.2
2	500978.58	5443536.29	3.60	0	63	60.5	60.5	0.0	0.0	55.5	0.0	-3.0	0.0	0.0	0.0	0.0	-0.0	8.0	8.0
3	500978.58	5443536.29	3.60	0	125	73.6	73.6	0.0	0.0	55.5	0.1	2.8	0.0	0.0	0.0	0.0	-0.0	15.3	15.3
4	500978.58	5443536.29	3.60	0	250	79.1	79.1	0.0	0.0	55.5	0.2	1.9	0.0	0.0	0.0	0.0	-0.0	21.6	21.6
5	500978.58	5443536.29	3.60	0	500	84.5	84.5	0.0	0.0	55.5	0.3	-0.9	0.0	0.0	0.0	0.0	-0.0	29.6	29.6
6	500978.58	5443536.29	3.60	0	1000	81.7	81.7	0.0	0.0	55.5	0.6	-0.9	0.0	0.0	0.0	0.0	-0.0	26.5	26.5
7	500978.58	5443536.29	3.60	0	2000	77.9	77.9	0.0	0.0	55.5	1.6	-0.9	0.0	0.0	0.0	0.0	-0.0	21.7	21.7
8	500978.58	5443536.29	3.60	0	4000	72.7	72.7	0.0	0.0	55.5	5.5	-0.9	0.0	0.0	0.0	0.0	-0.0	12.7	12.7
9	500978.58	5443536.29	3.60	0	8000	62.6	62.6	0.0	0.0	55.5	19.5	-0.9	0.0	0.0	0.0	0.0	-0.0	-11.5	-11.5

Point Source, ISO 9613, Name: "Em_Inv1", ID: "Em_Inv1"																			
Nr.	X	Y	Z	Refl.	Freq.	LxT	LxN	K0	Dc	Adiv	Aatm	Agr	Afol	Ahous	Abar	Cmet	RL	LrT	LrN
	(m)	(m)	(m)		(Hz)	dB(A)	dB(A)	(dB)	(dB)	(dB)	(dB)	(dB)	(dB)	(dB)	(dB)	(dB)	(dB)	dB(A)	dB(A)
1	500760.53	5441418.41	2.60	0	63	68.1	68.1	0.0	0.0	78.2	0.3	-5.7	0.0	0.0	0.0	0.0	-0.0	-4.6	-4.6
2	500760.53	5441418.41	2.60	0	125	78.9	78.9	0.0	0.0	78.2	0.9	4.2	0.0	0.0	0.0	0.0	-0.0	-4.4	-4.4
3	500760.53	5441418.41	2.60	0	250	85.5	85.5	0.0	0.0	78.2	2.4	2.5	0.0	0.0	0.0	0.0	-0.0	2.4	2.4
4	500760.53	5441418.41	2.60	0	500	87.3	87.3	0.0	0.0	78.2	4.4	-1.3	0.0	0.0	0.0	0.0	-0.0	6.0	6.0
5	500760.53	5441418.41	2.60	0	1000	83.7	83.7	0.0	0.0	78.2	8.4	-1.7	0.0	0.0	0.0	0.0	-0.0	-1.1	-1.1
6	500760.53	5441418.41	2.60	0	2000	79.1	79.1	0.0	0.0	78.2	22.1	-1.7	0.0	0.0	0.0	0.0	-0.0	-19.4	-19.4
7	500760.53	5441418.41	2.60	0	4000	70.0	70.0	0.0	0.0	78.2	74.8	-1.7	0.0	0.0	0.0	0.0	-0.0	-81.3	-81.3
8	500760.53	5441418.41	2.60	0	8000	77.7	77.7	0.0	0.0	78.2	266.9	-1.7	0.0	0.0	0.0	0.0	-0.0	-265.7	-265.7

Point Source, ISO 9613, Name: "Em_Inv2", ID: "Em_Inv2"																			
Nr.	X	Y	Z	Refl.	Freq.	LxT	LxN	K0	Dc	Adiv	Aatm	Agr	Afol	Ahous	Abar	Cmet	RL	LrT	LrN
	(m)	(m)	(m)		(Hz)	dB(A)	dB(A)	(dB)	(dB)	(dB)	(dB)	(dB)	(dB)	(dB)	(dB)	(dB)	(dB)	dB(A)	dB(A)
1	500552.40	5441520.21	2.60	0	63	68.1	68.1	0.0	0.0	77.9	0.3	-5.7	0.0	0.0	0.0	0.0	-0.0	-4.4	-4.4
2	500552.40	5441520.21	2.60	0	125	78.9	78.9	0.0	0.0	77.9	0.9	4.2	0.0	0.0	0.0	0.0	-0.0	-4.1	-4.1
3	500552.40	5441520.21	2.60	0	250	85.5	85.5	0.0	0.0	77.9	2.3	2.5	0.0	0.0	0.0	0.0	-0.0	2.7	2.7
4	500552.40	5441520.21	2.60	0	500	87.3	87.3	0.0	0.0	77.9	4.3	-1.3	0.0	0.0	0.0	0.0	-0.0	6.4	6.4
5	500552.40	5441520.21	2.60	0	1000	83.7	83.7	0.0	0.0	77.9	8.1	-1.7	0.0	0.0	0.0	0.0	-0.0	-0.7	-0.7
6	500552.40	5441520.21	2.60	0	2000	79.1	79.1	0.0	0.0	77.9	21.5	-1.7	0.0	0.0	0.0	0.0	-0.0	-18.6	-18.6
7	500552.40	5441520.21	2.60	0	4000	70.0	70.0	0.0	0.0	77.9	72.8	-1.7	0.0	0.0	0.0	0.0	-0.0	-79.0	-79.0
8	500552.40	5441520.21	2.60	0	8000	77.7	77.7	0.0	0.0	77.9	259.6	-1.7	0.0	0.0	0.0	0.0	-0.0	-258.1	-258.1

Point Source, ISO 9613, Name: "Em_Inv3", ID: "Em_Inv3"																			
Nr.	X	Y	Z	Refl.	Freq.	LxT	LxN	K0	Dc	Adiv	Aatm	Agr	Afol	Ahous	Abar	Cmet	RL	LrT	LrN
	(m)	(m)	(m)		(Hz)	dB(A)	dB(A)	(dB)	(dB)	(dB)	(dB)	(dB)	(dB)	(dB)	(dB)	(dB)	(dB)	dB(A)	dB(A)
1	500760.53	5441687.21	2.60	0	63	68.1	68.1	0.0	0.0	77.1	0.3	-5.7	0.0	0.0	0.0	0.0	-0.0	-3.6	-3.6
2	500760.53	5441687.21	2.60	0	125	78.9	78.9	0.0	0.0	77.1	0.8	4.2	0.0	0.0	0.0	0.0	-0.0	-3.2	-3.2
3	500760.53	5441687.21	2.60	0	250	85.5	85.5	0.0	0.0	77.1	2.1	2.5	0.0	0.0	0.0	0.0	-0.0	3.8	3.8
4	500760.53	5441687.21	2.60	0	500	87.3	87.3	0.0	0.0	77.1	3.9	-1.3	0.0	0.0	0.0	0.0	-0.0	7.6	7.6
5	500760.53	5441687.21	2.60	0	1000	83.7	83.7	0.0	0.0	77.1	7.4	-1.7	0.0	0.0	0.0	0.0	-0.0	0.9	0.9
6	500760.53	5441687.21	2.60	0	2000	79.1	79.1	0.0	0.0	77.1	19.5	-1.7	0.0	0.0	0.0	0.0	-0.0	-15.8	-15.8
7	500760.53	5441687.21	2.60	0	4000	70.0	70.0	0.0	0.0	77.1	66.1	-1.7	0.0	0.0	0.0	0.0	-0.0	-71.5	-71.5
8	500760.53	5441687.21	2.60	0	8000	77.7	77.7	0.0	0.0	77.1	235.8	-1.7	0.0	0.0	0.0	0.0	-0.0	-233.5	-233.5

Point Source, ISO 9613, Name: "Em_Inv4", ID: "Em_Inv4"																			
Nr.	X	Y	Z	Refl.	Freq.	LxT	LxN	K0	Dc	Adiv	Aatm	Agr	Afol	Ahous	Abar	Cmet	RL	LrT	LrN
	(m)	(m)	(m)		(Hz)	dB(A)	dB(A)	(dB)	(dB)	(dB)	(dB)	(dB)	(dB)	(dB)	(dB)	(dB)	(dB)	dB(A)	dB(A)
1	500516.20	5441733.01	2.60	0	63	68.1	68.1	0.0	0.0	77.1	0.3	-5.7	0.0	0.0	0.0	0.0	-0.0	-3.6	-3.6
2	500516.20	5441733.01	2.60	0	125	78.9	78.9	0.0	0.0	77.1	0.8	4.2	0.0	0.0	0.0	0.0	-0.0	-3.3	-3.3
3	500516.20	5441733.01	2.60	0	250	85.5	85.5	0.0	0.0	77.1	2.1	2.5	0.0	0.0	0.0	0.0	-0.0	3.7	3.7
4	500516.20	5441733.01	2.60	0	500	87.3	87.3	0.0	0.0	77.1	3.9	-1.3	0.0	0.0	0.0	0.0	-0.0	7.5	7.5
5	500516.20	5441733.01	2.60	0	1000	83.7	83.7	0.0	0.0	77.1	7.4	-1.7	0.0	0.0	0.0	0.0	-0.0	0.9	0.9

Point Source, ISO 9613, Name: "Em_Inv4", ID: "Em_Inv4"																			
Nr.	X	Y	Z	Refl.	Freq.	LxT	LxN	K0	Dc	Adiv	Aatm	Agr	Afol	Ahous	Abar	Cmet	RL	LrT	LrN
	(m)	(m)	(m)		(Hz)	dB(A)	dB(A)	(dB)	(dB)	(dB)	(dB)	(dB)	(dB)	(dB)	(dB)	(dB)	(dB)	dB(A)	dB(A)
6	500516.20	5441733.01	2.60	0	2000	79.1	79.1	0.0	0.0	77.1	19.6	-1.7	0.0	0.0	0.0	0.0	-0.0	-15.9	-15.9
7	500516.20	5441733.01	2.60	0	4000	70.0	70.0	0.0	0.0	77.1	66.3	-1.7	0.0	0.0	0.0	0.0	-0.0	-71.7	-71.7
8	500516.20	5441733.01	2.60	0	8000	77.7	77.7	0.0	0.0	77.1	236.5	-1.7	0.0	0.0	0.0	0.0	-0.0	-234.2	-234.2

Point Source, ISO 9613, Name: "Em_Inv5", ID: "Em_Inv5"																			
Nr.	X	Y	Z	Refl.	Freq.	LxT	LxN	K0	Dc	Adiv	Aatm	Agr	Afol	Ahous	Abar	Cmet	RL	LrT	LrN
	(m)	(m)	(m)		(Hz)	dB(A)	dB(A)	(dB)	(dB)	(dB)	(dB)	(dB)	(dB)	(dB)	(dB)	(dB)	(dB)	dB(A)	dB(A)
1	500760.53	5441956.01	2.60	0	63	68.1	68.1	0.0	0.0	75.9	0.2	-5.6	0.0	0.0	0.0	0.0	-0.0	-2.3	-2.3
2	500760.53	5441956.01	2.60	0	125	78.9	78.9	0.0	0.0	75.9	0.7	4.2	0.0	0.0	0.0	0.0	-0.0	-1.9	-1.9
3	500760.53	5441956.01	2.60	0	250	85.5	85.5	0.0	0.0	75.9	1.8	2.6	0.0	0.0	0.0	0.0	-0.0	5.2	5.2
4	500760.53	5441956.01	2.60	0	500	87.3	87.3	0.0	0.0	75.9	3.4	-1.3	0.0	0.0	0.0	0.0	-0.0	9.3	9.3
5	500760.53	5441956.01	2.60	0	1000	83.7	83.7	0.0	0.0	75.9	6.4	-1.7	0.0	0.0	0.0	0.0	-0.0	3.1	3.1
6	500760.53	5441956.01	2.60	0	2000	79.1	79.1	0.0	0.0	75.9	16.9	-1.7	0.0	0.0	0.0	0.0	-0.0	-12.0	-12.0
7	500760.53	5441956.01	2.60	0	4000	70.0	70.0	0.0	0.0	75.9	57.4	-1.7	0.0	0.0	0.0	0.0	-0.0	-61.6	-61.6
8	500760.53	5441956.01	2.60	0	8000	77.7	77.7	0.0	0.0	75.9	204.8	-1.7	0.0	0.0	0.0	0.0	-0.0	-201.3	-201.3

Point Source, ISO 9613, Name: "Em_Inv6", ID: "Em_Inv6"																			
Nr.	X	Y	Z	Refl.	Freq.	LxT	LxN	K0	Dc	Adiv	Aatm	Agr	Afol	Ahous	Abar	Cmet	RL	LrT	LrN
	(m)	(m)	(m)		(Hz)	dB(A)	dB(A)	(dB)	(dB)	(dB)	(dB)	(dB)	(dB)	(dB)	(dB)	(dB)	(dB)	dB(A)	dB(A)
1	500498.10	5441901.01	2.60	0	63	68.1	68.1	0.0	0.0	76.4	0.2	-5.7	0.0	0.0	0.0	0.0	-0.0	-2.9	-2.9
2	500498.10	5441901.01	2.60	0	125	78.9	78.9	0.0	0.0	76.4	0.8	4.2	0.0	0.0	0.0	0.0	-0.0	-2.5	-2.5
3	500498.10	5441901.01	2.60	0	250	85.5	85.5	0.0	0.0	76.4	2.0	2.5	0.0	0.0	0.0	0.0	-0.0	4.6	4.6
4	500498.10	5441901.01	2.60	0	500	87.3	87.3	0.0	0.0	76.4	3.6	-1.3	0.0	0.0	0.0	0.0	-0.0	8.5	8.5
5	500498.10	5441901.01	2.60	0	1000	83.7	83.7	0.0	0.0	76.4	6.8	-1.7	0.0	0.0	0.0	0.0	-0.0	2.1	2.1
6	500498.10	5441901.01	2.60	0	2000	79.1	79.1	0.0	0.0	76.4	18.1	-1.7	0.0	0.0	0.0	0.0	-0.0	-13.7	-13.7
7	500498.10	5441901.01	2.60	0	4000	70.0	70.0	0.0	0.0	76.4	61.2	-1.7	0.0	0.0	0.0	0.0	-0.0	-65.9	-65.9
8	500498.10	5441901.01	2.60	0	8000	77.7	77.7	0.0	0.0	76.4	218.3	-1.7	0.0	0.0	0.0	0.0	-0.0	-215.3	-215.3

Point Source, ISO 9613, Name: "Em_Inv7", ID: "Em_Inv7"																			
Nr.	X	Y	Z	Refl.	Freq.	LxT	LxN	K0	Dc	Adiv	Aatm	Agr	Afol	Ahous	Abar	Cmet	RL	LrT	LrN
	(m)	(m)	(m)		(Hz)	dB(A)	dB(A)	(dB)	(dB)	(dB)	(dB)	(dB)	(dB)	(dB)	(dB)	(dB)	(dB)	dB(A)	dB(A)
1	500498.10	5442057.81	2.60	0	63	68.1	68.1	0.0	0.0	75.7	0.2	-5.6	0.0	0.0	0.0	0.0	-0.0	-2.2	-2.2
2	500498.10	5442057.81	2.60	0	125	78.9	78.9	0.0	0.0	75.7	0.7	4.2	0.0	0.0	0.0	0.0	-0.0	-1.7	-1.7
3	500498.10	5442057.81	2.60	0	250	85.5	85.5	0.0	0.0	75.7	1.8	2.6	0.0	0.0	0.0	0.0	-0.0	5.4	5.4
4	500498.10	5442057.81	2.60	0	500	87.3	87.3	0.0	0.0	75.7	3.3	-1.3	0.0	0.0	0.0	0.0	-0.0	9.5	9.5
5	500498.10	5442057.81	2.60	0	1000	83.7	83.7	0.0	0.0	75.7	6.3	-1.7	0.0	0.0	0.0	0.0	-0.0	3.4	3.4
6	500498.10	5442057.81	2.60	0	2000	79.1	79.1	0.0	0.0	75.7	16.6	-1.7	0.0	0.0	0.0	0.0	-0.0	-11.5	-11.5
7	500498.10	5442057.81	2.60	0	4000	70.0	70.0	0.0	0.0	75.7	56.3	-1.7	0.0	0.0	0.0	0.0	-0.0	-60.3	-60.3
8	500498.10	5442057.81	2.60	0	8000	77.7	77.7	0.0	0.0	75.7	200.9	-1.7	0.0	0.0	0.0	0.0	-0.0	-197.2	-197.2

Point Source, ISO 9613, Name: "Em_Inv8", ID: "Em_Inv8"																			
Nr.	X	Y	Z	Refl.	Freq.	LxT	LxN	K0	Dc	Adiv	Aatm	Agr	Afol	Ahous	Abar	Cmet	RL	LrT	LrN
	(m)	(m)	(m)		(Hz)	dB(A)	dB(A)	(dB)	(dB)	(dB)	(dB)	(dB)	(dB)	(dB)	(dB)	(dB)	(dB)	dB(A)	dB(A)
1	500461.90	5442281.81	2.60	0	63	68.1	68.1	0.0	0.0	74.6	0.2	-5.6	0.0	0.0	0.0	0.0	-0.0	-1.2	-1.2
2	500461.90	5442281.81	2.60	0	125	78.9	78.9	0.0	0.0	74.6	0.6	4.2	0.0	0.0	0.0	0.0	-0.0	-0.6	-0.6
3	500461.90	5442281.81	2.60	0	250	85.5	85.5	0.0	0.0	74.6	1.6	2.6	0.0	0.0	0.0	0.0	-0.0	6.7	6.7
4	500461.90	5442281.81	2.60	0	500	87.3	87.3	0.0	0.0	74.6	2.9	-1.2	0.0	0.0	0.0	0.0	-0.0	11.0	11.0
5	500461.90	5442281.81	2.60	0	1000	83.7	83.7	0.0	0.0	74.6	5.6	-1.7	0.0	0.0	0.0	0.0	-0.0	5.1	5.1
6	500461.90	5442281.81	2.60	0	2000	79.1	79.1	0.0	0.0	74.6	14.7	-1.7	0.0	0.0	0.0	0.0	-0.0	-8.6	-8.6
7	500461.90	5442281.81	2.60	0	4000	70.0	70.0	0.0	0.0	74.6	49.9	-1.7	0.0	0.0	0.0	0.0	-0.0	-52.9	-52.9
8	500461.90	5442281.81	2.60	0	8000	77.7	77.7	0.0	0.0	74.6	178.0	-1.7	0.0	0.0	0.0	0.0	-0.0	-173.3	-173.3

Point Source, ISO 9613, Name: "Em_Inv9", ID: "Em_Inv9"																			
Nr.	X	Y	Z	Refl.	Freq.	LxT	LxN	K0	Dc	Adiv	Aatm	Agr	Afol	Ahous	Abar	Cmet	RL	LrT	LrN
	(m)	(m)	(m)		(Hz)	dB(A)	dB(A)	(dB)	(dB)	(dB)	(dB)	(dB)	(dB)	(dB)	(dB)	(dB)	(dB)	dB(A)	dB(A)
1	500651.93	5442280.81	2.60	0	63	68.1	68.1	0.0	0.0	74.3	0.2	-5.6	0.0	0.0	0.0	0.0	-0.0	-0.8	-0.8
2	500651.93	5442280.81	2.60	0	125	78.9	78.9	0.0	0.0	74.3	0.6	4.2	0.0	0.0	0.0	0.0	-0.0	-0.2	-0.2
3	500651.93	5442280.81	2.60	0	250	85.5	85.5	0.0	0.0	74.3	1.5	2.6	0.0	0.0	0.0	0.0	-0.0	7.1	7.1
4	500651.93	5442280.81	2.60	0	500	87.3	87.3	0.0	0.0	74.3	2.8	-1.2	0.0	0.0	0.0	0.0	-0.0	11.4	11.4
5	500651.93	5442280.81	2.60	0	1000	83.7	83.7	0.0	0.0	74.3	5.3	-1.7	0.0	0.0	0.0	0.0	-0.0	5.7	5.7
6	500651.93	5442280.81	2.60	0	2000	79.1	79.1	0.0	0.0	74.3	14.1	-1.7	0.0	0.0	0.0	0.0	-0.0	-7.6	-7.6
7	500651.93	5442280.81	2.60	0	4000	70.0	70.0	0.0	0.0	74.3	47.8	-1.7	0.0	0.0	0.0	0.0	-0.0	-50.4	-50.4
8	500651.93	5442280.81	2.60	0	8000	77.7	77.7	0.0	0.0	74.3	170.6	-1.7	0.0	0.0	0.0	0.0	-0.0	-165.5	-165.5

Point Source, ISO 9613, Name: "Em_Inv10", ID: "Em_Inv10"																			
Nr.	X	Y	Z	Refl.	Freq.	LxT	LxN	K0	Dc	Adiv	Aatm	Agr	Afol	Ahous	Abar	Cmet	RL	LrT	LrN
	(m)	(m)	(m)		(Hz)	dB(A)	dB(A)	(dB)	(dB)	(dB)	(dB)	(dB)	(dB)	(dB)	(dB)	(dB)	(dB)	dB(A)	dB(A)
1	499992.71	5441665.81	2.60	0	63	68.1	68.1	0.0	0.0	78.2	0.3	-5.7	0.0	0.0	0.0	0.0	-0.0	-4.6	-4.6
2	499992.71	5441665.81	2.60	0	125	78.9	78.9	0.0	0.0	78.2	0.9	4.2	0.0	0.0	0.0	0.0	-0.0	-4.4	-4.4
3	499992.71	5441665.81	2.60	0	250	85.5	85.5	0.0	0.0	78.2	2.4	2.5	0.0	0.0	0.0	0.0	-0.0	2.4	2.4
4	499992.71	5441665.81	2.60	0	500	87.3	87.3	0.0	0.0	78.2	4.4	-1.3	0.0	0.0	0.0	0.0	-0.0	6.0	6.0
5	499992.71	5441665.81	2.60	0	1000	83.7	83.7	0.0	0.0	78.2	8.4	-1.7	0.0	0.0	0.0	0.0	-0.0	-1.1	-1.1
6	499992.71	5441665.81	2.60	0	2000	79.1	79.1	0.0	0.0	78.2	22.1	-1.7	0.0	0.0	0.0	0.0	-0.0	-19.4	-19.4
7	499992.71	5441665.81	2.60	0	4000	70.0	70.0	0.0	0.0	78.2	74.8	-1.7	0.0	0.0	0.0	0.0	-0.0	-81.2	-81.2
8	499992.71	5441665.81	2.60	0	8000	77.7	77.7	0.0	0.0	78.2	266.7	-1.7	0.0	0.0	0.0	0.0	-0.0	-265.4	-265.4

Point Source, ISO 9613, Name: "Em_Inv11", ID: "Em_Inv11"																			
Nr.	X	Y	Z	Refl.	Freq.	LxT	LxN	K0	Dc	Adiv	Aatm	Agr	Afol	Ahous	Abar	Cmet	RL	LrT	LrN
	(m)	(m)	(m)		(Hz)	dB(A)	dB(A)	(dB)	(dB)	(dB)	(dB)	(dB)	(dB)	(dB)	(dB)	(dB)	(dB)	dB(A)	dB(A)
1	499992.71	5441505.71	2.60	0	63	68.1	68.1	0.0	0.0	78.7	0.3	-5.7	0.0	0.0	0.0	0.0	-0.0	-5.1	-5.1
2	499992.71	5441505.71	2.60	0	125	78.9	78.9	0.0	0.0	78.7	1.0	4.2	0.0	0.0	0.0	0.0	-0.0	-5.0	-5.0
3	499992.71	5441505.71	2.60	0	250	85.5	85.5	0.0	0.0	78.7	2.5	2.5	0.0	0.0	0.0	0.0	-0.0	1.8	1.8
4	499992.71	5441505.71	2.60	0	500	87.3	87.3	0.0	0.0	78.7	4.7	-1.3	0.0	0.0	0.0	0.0	-0.0	5.2	5.2
5	499992.71	5441505.71	2.60	0	1000	83.7	83.7	0.0	0.0	78.7	8.9	-1.7	0.0	0.0	0.0	0.0	-0.0	-2.1	-2.1
6	499992.71	5441505.71	2.60	0	2000	79.1	79.1	0.0	0.0	78.7	23.4	-1.7	0.0	0.0	0.0	0.0	-0.0	-21.3	-21.3
7	499992.71	5441505.71	2.60	0	4000	70.0	70.0	0.0	0.0	78.7	79.4	-1.7	0.0	0.0	0.0	0.0	-0.0	-86.4	-86.4
8	499992.71	5441505.71	2.60	0	8000	77.7	77.7	0.0	0.0	78.7	283.3	-1.7	0.0	0.0	0.0	0.0	-0.0	-282.6	-282.6

Point Source, ISO 9613, Name: "Em_Trans1", ID: "Em_Trans1"																			
Nr.	X	Y	Z	Refl.	Freq.	LxT	LxN	K0	Dc	Adiv	Aatm	Agr	Afol	Ahous	Abar	Cmet	RL	LrT	LrN
	(m)	(m)	(m)		(Hz)	dB(A)	dB(A)	(dB)	(dB)	(dB)	(dB)	(dB)	(dB)	(dB)	(dB)	(dB)	(dB)	dB(A)	dB(A)
1	500755.03	5441418.91	2.58	0	32	37.3	37.3	0.0	0.0	78.2	0.1	-5.7	0.0	0.0	0.0	0.0	-0.0	-35.2	-35.2
2	500755.03	5441418.91	2.58	0	63	56.5	56.5	0.0	0.0	78.2	0.3	-5.7	0.0	0.0	0.0	0.0	-0.0	-16.2	-16.2
3	500755.03	5441418.91	2.58	0	125	68.6	68.6	0.0	0.0	78.2	0.9	4.2	0.0	0.0	0.0	0.0	-0.0	-14.7	-14.7
4	500755.03	5441418.91	2.58	0	250	71.1	71.1	0.0	0.0	78.2	2.4	2.6	0.0	0.0	0.0	0.0	-0.0	-12.0	-12.0
5	500755.03	5441418.91	2.58	0	500	76.5	76.5	0.0	0.0	78.2	4.4	-1.3	0.0	0.0	0.0	0.0	-0.0	-4.8	-4.8
6	500755.03	5441418.91	2.58	0	1000	73.7	73.7	0.0	0.0	78.2	8.4	-1.7	0.0	0.0	0.0	0.0	-0.0	-11.1	-11.1
7	500755.03	5441418.91	2.58	0	2000	69.9	69.9	0.0	0.0	78.2	22.1	-1.7	0.0	0.0	0.0	0.0	-0.0	-28.6	-28.6
8	500755.03	5441418.91	2.58	0	4000	64.7	64.7	0.0	0.0	78.2	74.8	-1.7	0.0	0.0	0.0	0.0	-0.0	-86.6	-86.6
9	500755.03	5441418.91	2.58	0	8000	55.6	55.6	0.0	0.0	78.2	266.9	-1.7	0.0	0.0	0.0	0.0	-0.0	-287.8	-287.8

Point Source, ISO 9613, Name: "Em_Trans2", ID: "Em_Trans2"																			
Nr.	X	Y	Z	Refl.	Freq.	LxT	LxN	K0	Dc	Adiv	Aatm	Agr	Afol	Ahous	Abar	Cmet	RL	LrT	LrN
	(m)	(m)	(m)		(Hz)	dB(A)	dB(A)	(dB)	(dB)	(dB)	(dB)	(dB)	(dB)	(dB)	(dB)	(dB)	(dB)	dB(A)	dB(A)
1	500557.90	5441519.71	2.58	0	32	37.3	37.3	0.0	0.0	77.9	0.1	-5.7	0.0	0.0	0.0	0.0	-0.0	-35.0	-35.0
2	500557.90	5441519.71	2.58	0	63	56.5	56.5	0.0	0.0	77.9	0.3	-5.7	0.0	0.0	0.0	0.0	-0.0	-16.0	-16.0
3	500557.90	5441519.71	2.58	0	125	68.6	68.6	0.0	0.0	77.9	0.9	4.2	0.0	0.0	0.0	0.0	-0.0	-14.4	-14.4
4	500557.90	5441519.71	2.58	0	250	71.1	71.1	0.0	0.0	77.9	2.3	2.6	0.0	0.0	0.0	0.0	-0.0	-11.7	-11.7
5	500557.90	5441519.71	2.58	0	500	76.5	76.5	0.0	0.0	77.9	4.3	-1.3	0.0	0.0	0.0	0.0	-0.0	-4.5	-4.5
6	500557.90	5441519.71	2.58	0	1000	73.7	73.7	0.0	0.0	77.9	8.1	-1.7	0.0	0.0	0.0	0.0	-0.0	-10.6	-10.6
7	500557.90	5441519.71	2.58	0	2000	69.9	69.9	0.0	0.0	77.9	21.4	-1.7	0.0	0.0	0.0	0.0	-0.0	-27.8	-27.8
8	500557.90	5441519.71	2.58	0	4000	64.7	64.7	0.0	0.0	77.9	72.8	-1.7	0.0	0.0	0.0	0.0	-0.0	-84.3	-84.3
9	500557.90	5441519.71	2.58	0	8000	55.6	55.6	0.0	0.0	77.9	259.5	-1.7	0.0	0.0	0.0	0.0	-0.0	-280.1	-280.1

Point Source, ISO 9613, Name: "Em_Trans3", ID: "Em_Trans3"																			
Nr.	X	Y	Z	Refl.	Freq.	LxT	LxN	K0	Dc	Adiv	Aatm	Agr	Afol	Ahous	Abar	Cmet	RL	LrT	LrN
	(m)	(m)	(m)		(Hz)	dB(A)	dB(A)	(dB)	(dB)	(dB)	(dB)	(dB)	(dB)	(dB)	(dB)	(dB)	(dB)	dB(A)	dB(A)
1	500755.03	5441687.71	2.58	0	32	37.3	37.3	0.0	0.0	77.1	0.1	-5.7	0.0	0.0	0.0	0.0	-0.0	-34.2	-34.2
2	500755.03	5441687.71	2.58	0	63	56.5	56.5	0.0	0.0	77.1	0.3	-5.7	0.0	0.0	0.0	0.0	-0.0	-15.2	-15.2
3	500755.03	5441687.71	2.58	0	125	68.6	68.6	0.0	0.0	77.1	0.8	4.2	0.0	0.0	0.0	0.0	-0.0	-13.5	-13.5
4	500755.03	5441687.71	2.58	0	250	71.1	71.1	0.0	0.0	77.1	2.1	2.6	0.0	0.0	0.0	0.0	-0.0	-10.7	-10.7
5	500755.03	5441687.71	2.58	0	500	76.5	76.5	0.0	0.0	77.1	3.9	-1.3	0.0	0.0	0.0	0.0	-0.0	-3.2	-3.2
6	500755.03	5441687.71	2.58	0	1000	73.7	73.7	0.0	0.0	77.1	7.4	-1.7	0.0	0.0	0.0	0.0	-0.0	-9.1	-9.1
7	500755.03	5441687.71	2.58	0	2000	69.9	69.9	0.0	0.0	77.1	19.5	-1.7	0.0	0.0	0.0	0.0	-0.0	-25.0	-25.0
8	500755.03	5441687.71	2.58	0	4000	64.7	64.7	0.0	0.0	77.1	66.1	-1.7	0.0	0.0	0.0	0.0	-0.0	-76.8	-76.8
9	500755.03	5441687.71	2.58	0	8000	55.6	55.6	0.0	0.0	77.1	235.8	-1.7	0.0	0.0	0.0	0.0	-0.0	-255.6	-255.6

Point Source, ISO 9613, Name: "Em_Trans4", ID: "Em_Trans4"																			
Nr.	X	Y	Z	Refl.	Freq.	LxT	LxN	K0	Dc	Adiv	Aatm	Agr	Afol	Ahous	Abar	Cmet	RL	LrT	LrN
	(m)	(m)	(m)		(Hz)	dB(A)	dB(A)	(dB)	(dB)	(dB)	(dB)	(dB)	(dB)	(dB)	(dB)	(dB)	(dB)	dB(A)	dB(A)
1	500521.70	5441732.51	2.58	0	32	37.3	37.3	0.0	0.0	77.1	0.1	-5.7	0.0	0.0	0.0	0.0	-0.0	-34.2	-34.2
2	500521.70	5441732.51	2.58	0	63	56.5	56.5	0.0	0.0	77.1	0.3	-5.7	0.0	0.0	0.0	0.0	-0.0	-15.2	-15.2
3	500521.70	5441732.51	2.58	0	125	68.6	68.6	0.0	0.0	77.1	0.8	4.2	0.0	0.0	0.0	0.0	-0.0	-13.6	-13.6
4	500521.70	5441732.51	2.58	0	250	71.1	71.1	0.0	0.0	77.1	2.1	2.6	0.0	0.0	0.0	0.0	-0.0	-10.7	-10.7
5	500521.70	5441732.51	2.58	0	500	76.5	76.5	0.0	0.0	77.1	3.9	-1.3	0.0	0.0	0.0	0.0	-0.0	-3.3	-3.3
6	500521.70	5441732.51	2.58	0	1000	73.7	73.7	0.0	0.0	77.1	7.4	-1.7	0.0	0.0	0.0	0.0	-0.0	-9.1	-9.1
7	500521.70	5441732.51	2.58	0	2000	69.9	69.9	0.0	0.0	77.1	19.6	-1.7	0.0	0.0	0.0	0.0	-0.0	-25.1	-25.1
8	500521.70	5441732.51	2.58	0	4000	64.7	64.7	0.0	0.0	77.1	66.3	-1.7	0.0	0.0	0.0	0.0	-0.0	-77.0	-77.0
9	500521.70	5441732.51	2.58	0	8000	55.6	55.6	0.0	0.0	77.1	236.4	-1.7	0.0	0.0	0.0	0.0	-0.0	-256.2	-256.2

Point Source, ISO 9613, Name: "Em_Trans5", ID: "Em_Trans5"																			
Nr.	X	Y	Z	Refl.	Freq.	LxT	LxN	K0	Dc	Adiv	Aatm	Agr	Afol	Ahous	Abar	Cmet	RL	LrT	LrN
	(m)	(m)	(m)		(Hz)	dB(A)	dB(A)	(dB)	(dB)	(dB)	(dB)	(dB)	(dB)	(dB)	(dB)	(dB)	(dB)	dB(A)	dB(A)
1	500755.03	5441956.51	2.58	0	32	37.3	37.3	0.0	0.0	75.9	0.1	-5.6	0.0	0.0	0.0	0.0	-0.0	-33.0	-33.0
2	500755.03	5441956.51	2.58	0	63	56.5	56.5	0.0	0.0	75.9	0.2	-5.6	0.0	0.0	0.0	0.0	-0.0	-14.0	-14.0
3	500755.03	5441956.51	2.58	0	125	68.6	68.6	0.0	0.0	75.9	0.7	4.2	0.0	0.0	0.0	0.0	-0.0	-12.2	-12.2
4	500755.03	5441956.51	2.58	0	250	71.1	71.1	0.0	0.0	75.9	1.8	2.6	0.0	0.0	0.0	0.0	-0.0	-9.2	-9.2
5	500755.03	5441956.51	2.58	0	500	76.5	76.5	0.0	0.0	75.9	3.4	-1.2	0.0	0.0	0.0	0.0	-0.0	-1.5	-1.5
6	500755.03	5441956.51	2.58	0	1000	73.7	73.7	0.0	0.0	75.9	6.4	-1.7	0.0	0.0	0.0	0.0	-0.0	-6.9	-6.9
7	500755.03	5441956.51	2.58	0	2000	69.9	69.9	0.0	0.0	75.9	16.9	-1.7	0.0	0.0	0.0	0.0	-0.0	-21.2	-21.2
8	500755.03	5441956.51	2.58	0	4000	64.7	64.7	0.0	0.0	75.9	57.4	-1.7	0.0	0.0	0.0	0.0	-0.0	-66.9	-66.9
9	500755.03	5441956.51	2.58	0	8000	55.6	55.6	0.0	0.0	75.9	204.8	-1.7	0.0	0.0	0.0	0.0	-0.0	-223.4	-223.4

Point Source, ISO 9613, Name: "Em_Trans6", ID: "Em_Trans6"																			
Nr.	X	Y	Z	Refl.	Freq.	LxT	LxN	K0	Dc	Adiv	Aatm	Agr	Afol	Ahous	Abar	Cmet	RL	LrT	LrN
	(m)	(m)	(m)		(Hz)	dB(A)	dB(A)	(dB)	(dB)	(dB)	(dB)	(dB)	(dB)	(dB)	(dB)	(dB)	(dB)	dB(A)	dB(A)
1	500503.60	5441900.51	2.58	0	32	37.3	37.3	0.0	0.0	76.4	0.1	-5.7	0.0	0.0	0.0	0.0	-0.0	-33.5	-33.5
2	500503.60	5441900.51	2.58	0	63	56.5	56.5	0.0	0.0	76.4	0.2	-5.7	0.0	0.0	0.0	0.0	-0.0	-14.5	-14.5
3	500503.60	5441900.51	2.58	0	125	68.6	68.6	0.0	0.0	76.4	0.8	4.2	0.0	0.0	0.0	0.0	-0.0	-12.8	-12.8
4	500503.60	5441900.51	2.58	0	250	71.1	71.1	0.0	0.0	76.4	2.0	2.6	0.0	0.0	0.0	0.0	-0.0	-9.9	-9.9
5	500503.60	5441900.51	2.58	0	500	76.5	76.5	0.0	0.0	76.4	3.6	-1.2	0.0	0.0	0.0	0.0	-0.0	-2.3	-2.3
6	500503.60	5441900.51	2.58	0	1000	73.7	73.7	0.0	0.0	76.4	6.8	-1.7	0.0	0.0	0.0	0.0	-0.0	-7.9	-7.9
7	500503.60	5441900.51	2.58	0	2000	69.9	69.9	0.0	0.0	76.4	18.0	-1.7	0.0	0.0	0.0	0.0	-0.0	-22.9	-22.9
8	500503.60	5441900.51	2.58	0	4000	64.7	64.7	0.0	0.0	76.4	61.2	-1.7	0.0	0.0	0.0	0.0	-0.0	-71.2	-71.2
9	500503.60	5441900.51	2.58	0	8000	55.6	55.6	0.0	0.0	76.4	218.2	-1.7	0.0	0.0	0.0	0.0	-0.0	-237.3	-237.3

Point Source, ISO 9613, Name: "Em_Trans7", ID: "Em_Trans7"																			
Nr.	X	Y	Z	Refl.	Freq.	LxT	LxN	K0	Dc	Adiv	Aatm	Agr	Afol	Ahous	Abar	Cmet	RL	LrT	LrN
	(m)	(m)	(m)		(Hz)	dB(A)	dB(A)	(dB)	(dB)	(dB)	(dB)	(dB)	(dB)	(dB)	(dB)	(dB)	(dB)	dB(A)	dB(A)
1	500503.60	5442057.31	2.58	0	32	37.3	37.3	0.0	0.0	75.7	0.1	-5.6	0.0	0.0	0.0	0.0	-0.0	-32.8	-32.8
2	500503.60	5442057.31	2.58	0	63	56.5	56.5	0.0	0.0	75.7	0.2	-5.6	0.0	0.0	0.0	0.0	-0.0	-13.8	-13.8
3	500503.60	5442057.31	2.58	0	125	68.6	68.6	0.0	0.0	75.7	0.7	4.2	0.0	0.0	0.0	0.0	-0.0	-12.0	-12.0
4	500503.60	5442057.31	2.58	0	250	71.1	71.1	0.0	0.0	75.7	1.8	2.6	0.0	0.0	0.0	0.0	-0.0	-9.0	-9.0
5	500503.60	5442057.31	2.58	0	500	76.5	76.5	0.0	0.0	75.7	3.3	-1.2	0.0	0.0	0.0	0.0	-0.0	-1.3	-1.3
6	500503.60	5442057.31	2.58	0	1000	73.7	73.7	0.0	0.0	75.7	6.3	-1.7	0.0	0.0	0.0	0.0	-0.0	-6.6	-6.6
7	500503.60	5442057.31	2.58	0	2000	69.9	69.9	0.0	0.0	75.7	16.6	-1.7	0.0	0.0	0.0	0.0	-0.0	-20.7	-20.7
8	500503.60	5442057.31	2.58	0	4000	64.7	64.7	0.0	0.0	75.7	56.3	-1.7	0.0	0.0	0.0	0.0	-0.0	-65.6	-65.6
9	500503.60	5442057.31	2.58	0	8000	55.6	55.6	0.0	0.0	75.7	200.8	-1.7	0.0	0.0	0.0	0.0	-0.0	-219.2	-219.2

Point Source, ISO 9613, Name: "Em_Trans8", ID: "Em_Trans8"																			
Nr.	X	Y	Z	Refl.	Freq.	LxT	LxN	K0	Dc	Adiv	Aatm	Agr	Afol	Ahous	Abar	Cmet	RL	LrT	LrN
	(m)	(m)	(m)		(Hz)	dB(A)	dB(A)	(dB)	(dB)	(dB)	(dB)	(dB)	(dB)	(dB)	(dB)	(dB)	(dB)	dB(A)	dB(A)
1	500467.40	5442281.31	2.58	0	32	37.3	37.3	0.0	0.0	74.6	0.1	-5.6	0.0	0.0	0.0	0.0	-0.0	-31.8	-31.8
2	500467.40	5442281.31	2.58	0	63	56.5	56.5	0.0	0.0	74.6	0.2	-5.6	0.0	0.0	0.0	0.0	-0.0	-12.8	-12.8
3	500467.40	5442281.31	2.58	0	125	68.6	68.6	0.0	0.0	74.6	0.6	4.2	0.0	0.0	0.0	0.0	-0.0	-10.9	-10.9
4	500467.40	5442281.31	2.58	0	250	71.1	71.1	0.0	0.0	74.6	1.6	2.6	0.0	0.0	0.0	0.0	-0.0	-7.7	-7.7
5	500467.40	5442281.31	2.58	0	500	76.5	76.5	0.0	0.0	74.6	2.9	-1.2	0.0	0.0	0.0	0.0	-0.0	0.1	0.1
6	500467.40	5442281.31	2.58	0	1000	73.7	73.7	0.0	0.0	74.6	5.6	-1.7	0.0	0.0	0.0	0.0	-0.0	-4.8	-4.8
7	500467.40	5442281.31	2.58	0	2000	69.9	69.9	0.0	0.0	74.6	14.7	-1.7	0.0	0.0	0.0	0.0	-0.0	-17.8	-17.8
8	500467.40	5442281.31	2.58	0	4000	64.7	64.7	0.0	0.0	74.6	49.8	-1.7	0.0	0.0	0.0	0.0	-0.0	-58.1	-58.1
9	500467.40	5442281.31	2.58	0	8000	55.6	55.6	0.0	0.0	74.6	177.8	-1.7	0.0	0.0	0.0	0.0	-0.0	-195.2	-195.2

Point Source, ISO 9613, Name: "Em_Trans9", ID: "Em_Trans9"																			
Nr.	X	Y	Z	Refl.	Freq.	LxT	LxN	K0	Dc	Adiv	Aatm	Agr	Afol	Ahous	Abar	Cmet	RL	LrT	LrN
	(m)	(m)	(m)		(Hz)	dB(A)	dB(A)	(dB)	(dB)	(dB)	(dB)	(dB)	(dB)	(dB)	(dB)	(dB)	(dB)	dB(A)	dB(A)
1	500646.43	5442281.31	2.58	0	32	37.3	37.3	0.0	0.0	74.3	0.1	-5.6	0.0	0.0	0.0	0.0	-0.0	-31.5	-31.5
2	500646.43	5442281.31	2.58	0	63	56.5	56.5	0.0	0.0	74.3	0.2	-5.6	0.0	0.0	0.0	0.0	-0.0	-12.4	-12.4
3	500646.43	5442281.31	2.58	0	125	68.6	68.6	0.0	0.0	74.3	0.6	4.2	0.0	0.0	0.0	0.0	-0.0	-10.5	-10.5
4	500646.43	5442281.31	2.58	0	250	71.1	71.1	0.0	0.0	74.3	1.5	2.6	0.0	0.0	0.0	0.0	-0.0	-7.3	-7.3
5	500646.43	5442281.31	2.58	0	500	76.5	76.5	0.0	0.0	74.3	2.8	-1.2	0.0	0.0	0.0	0.0	-0.0	0.6	0.6
6	500646.43	5442281.31	2.58	0	1000	73.7	73.7	0.0	0.0	74.3	5.3	-1.7	0.0	0.0	0.0	0.0	-0.0	-4.3	-4.3
7	500646.43	5442281.31	2.58	0	2000	69.9	69.9	0.0	0.0	74.3	14.1	-1.7	0.0	0.0	0.0	0.0	-0.0	-16.8	-16.8
8	500646.43	5442281.31	2.58	0	4000	64.7	64.7	0.0	0.0	74.3	47.9	-1.7	0.0	0.0	0.0	0.0	-0.0	-55.8	-55.8
9	500646.43	5442281.31	2.58	0	8000	55.6	55.6	0.0	0.0	74.3	170.7	-1.7	0.0	0.0	0.0	0.0	-0.0	-187.8	-187.8

Point Source, ISO 9613, Name: "Em_Trans10", ID: "Em_Trans10"																			
Nr.	X	Y	Z	Refl.	Freq.	LxT	LxN	K0	Dc	Adiv	Aatm	Agr	Afol	Ahous	Abar	Cmet	RL	LrT	LrN
	(m)	(m)	(m)		(Hz)	dB(A)	dB(A)	(dB)	(dB)	(dB)	(dB)	(dB)	(dB)	(dB)	(dB)	(dB)	(dB)	dB(A)	dB(A)
1	499998.21	5441665.31	2.58	0	32	37.3	37.3	0.0	0.0	78.2	0.1	-5.7	0.0	0.0	0.0	0.0	-0.0	-35.2	-35.2
2	499998.21	5441665.31	2.58	0	63	56.5	56.5	0.0	0.0	78.2	0.3	-5.7	0.0	0.0	0.0	0.0	-0.0	-16.2	-16.2
3	499998.21	5441665.31	2.58	0	125	68.6	68.6	0.0	0.0	78.2	0.9	4.2	0.0	0.0	0.0	0.0	-0.0	-14.7	-14.7
4	499998.21	5441665.31	2.58	0	250	71.1	71.1	0.0	0.0	78.2	2.4	2.6	0.0	0.0	0.0	0.0	-0.0	-12.0	-12.0
5	499998.21	5441665.31	2.58	0	500	76.5	76.5	0.0	0.0	78.2	4.4	-1.3	0.0	0.0	0.0	0.0	-0.0	-4.8	-4.8
6	499998.21	5441665.31	2.58	0	1000	73.7	73.7	0.0	0.0	78.2	8.3	-1.7	0.0	0.0	0.0	0.0	-0.0	-11.1	-11.1
7	499998.21	5441665.31	2.58	0	2000	69.9	69.9	0.0	0.0	78.2	22.0	-1.7	0.0	0.0	0.0	0.0	-0.0	-28.6	-28.6
8	499998.21	5441665.31	2.58	0	4000	64.7	64.7	0.0	0.0	78.2	74.7	-1.7	0.0	0.0	0.0	0.0	-0.0	-86.4	-86.4
9	499998.21	5441665.31	2.58	0	8000	55.6	55.6	0.0	0.0	78.2	266.4	-1.7	0.0	0.0	0.0	0.0	-0.0	-287.3	-287.3

Point Source, ISO 9613, Name: "Em_Trans11", ID: "Em_Trans11"																			
Nr.	X	Y	Z	Refl.	Freq.	LxT	LxN	K0	Dc	Adiv	Aatm	Agr	Afol	Ahous	Abar	Cmet	RL	LrT	LrN
	(m)	(m)	(m)		(Hz)	dB(A)	dB(A)	(dB)	(dB)	(dB)	(dB)	(dB)	(dB)	(dB)	(dB)	(dB)	(dB)	dB(A)	dB(A)
1	499998.21	5441505.21	2.58	0	32	37.3	37.3	0.0	0.0	78.7	0.1	-5.7	0.0	0.0	0.0	0.0	-0.0	-35.7	-35.7
2	499998.21	5441505.21	2.58	0	63	56.5	56.5	0.0	0.0	78.7	0.3	-5.7	0.0	0.0	0.0	0.0	-0.0	-16.7	-16.7
3	499998.21	5441505.21	2.58	0	125	68.6	68.6	0.0	0.0	78.7	1.0	4.2	0.0	0.0	0.0	0.0	-0.0	-15.3	-15.3
4	499998.21	5441505.21	2.58	0	250	71.1	71.1	0.0	0.0	78.7	2.5	2.6	0.0	0.0	0.0	0.0	-0.0	-12.7	-12.7
5	499998.21	5441505.21	2.58	0	500	76.5	76.5	0.0	0.0	78.7	4.7	-1.3	0.0	0.0	0.0	0.0	-0.0	-5.6	-5.6
6	499998.21	5441505.21	2.58	0	1000	73.7	73.7	0.0	0.0	78.7	8.9	-1.7	0.0	0.0	0.0	0.0	-0.0	-12.1	-12.1
7	499998.21	5441505.21	2.58	0	2000	69.9	69.9	0.0	0.0	78.7	23.4	-1.7	0.0	0.0	0.0	0.0	-0.0	-30.5	-30.5
8	499998.21	5441505.21	2.58	0	4000	64.7	64.7	0.0	0.0	78.7	79.4	-1.7	0.0	0.0	0.0	0.0	-0.0	-91.6	-91.6
9	499998.21	5441505.21	2.58	0	8000	55.6	55.6	0.0	0.0	78.7	283.1	-1.7	0.0	0.0	0.0	0.0	-0.0	-304.5	-304.5

Point Source, ISO 9613, Name: "MM_Sub115", ID: "MM_Sub115"																			
Nr.	X	Y	Z	Refl.	Freq.	LxT	LxN	K0	Dc	Adiv	Aatm	Agr	Afol	Ahous	Abar	Cmet	RL	LrT	LrN
	(m)	(m)	(m)		(Hz)	dB(A)	dB(A)	(dB)	(dB)	(dB)	(dB)	(dB)	(dB)	(dB)	(dB)	(dB)	(dB)	dB(A)	dB(A)
1	500993.61	5443521.27	3.60	0	32	43.3	43.3	0.0	0.0	55.8	0.0	-3.0	0.0	0.0	0.0	0.0	-0.0	-9.5	-9.5
2	500993.61	5443521.27	3.60	0	63	60.5	60.5	0.0	0.0	55.8	0.0	-3.0	0.0	0.0	0.0	0.0	-0.0	7.7	7.7
3	500993.61	5443521.27	3.60	0	125	73.6	73.6	0.0	0.0	55.8	0.1	2.8	0.0	0.0	0.0	0.0	-0.0	14.9	14.9
4	500993.61	5443521.27	3.60	0	250	79.1	79.1	0.0	0.0	55.8	0.2	1.9	0.0	0.0	0.0	0.0	-0.0	21.2	21.2
5	500993.61	5443521.27	3.60	0	500	84.5	84.5	0.0	0.0	55.8	0.3	-0.9	0.0	0.0	0.0	0.0	-0.0	29.2	29.2
6	500993.61	5443521.27	3.60	0	1000	81.7	81.7	0.0	0.0	55.8	0.6	-0.9	0.0	0.0	0.0	0.0	-0.0	26.2	26.2
7	500993.61	5443521.27	3.60	0	2000	77.9	77.9	0.0	0.0	55.8	1.7	-0.9	0.0	0.0	0.0	0.0	-0.0	21.3	21.3
8	500993.61	5443521.27	3.60	0	4000	72.7	72.7	0.0	0.0	55.8	5.7	-0.9	0.0	0.0	0.0	0.0	-0.0	12.1	12.1
9	500993.61	5443521.27	3.60	0	8000	62.6	62.6	0.0	0.0	55.8	20.4	-0.9	0.0	0.0	0.0	0.0	-0.0	-12.7	-12.7

Point Source, ISO 9613, Name: "MM_Inv1", ID: "MM_Inv1"																			
Nr.	X	Y	Z	Refl.	Freq.	LxT	LxN	K0	Dc	Adiv	Aatm	Agr	Afol	Ahous	Abar	Cmet	RL	LrT	LrN
	(m)	(m)	(m)		(Hz)	dB(A)	dB(A)	(dB)	(dB)	(dB)	(dB)	(dB)	(dB)	(dB)	(dB)	(dB)	(dB)	dB(A)	dB(A)
1	501222.00	5443157.66	2.60	0	63	68.1	68.1	0.0	0.0	65.8	0.1	-4.8	0.0	0.0	0.0	0.0	-0.0	7.1	7.1
2	501222.00	5443157.66	2.60	0	125	78.9	78.9	0.0	0.0	65.8	0.2	3.2	0.0	0.0	0.0	0.0	-0.0	9.6	9.6
3	501222.00	5443157.66	2.60	0	250	85.5	85.5	0.0	0.0	65.8	0.6	2.8	0.0	0.0	0.0	0.0	-0.0	16.3	16.3
4	501222.00	5443157.66	2.60	0	500	87.3	87.3	0.0	0.0	65.8	1.1	-1.0	0.0	0.0	0.0	0.0	-0.0	21.5	21.5
5	501222.00	5443157.66	2.60	0	1000	83.7	83.7	0.0	0.0	65.8	2.0	-1.4	0.0	0.0	0.0	0.0	-0.0	17.4	17.4
6	501222.00	5443157.66	2.60	0	2000	79.1	79.1	0.0	0.0	65.8	5.3	-1.5	0.0	0.0	0.0	0.0	-0.0	9.5	9.5
7	501222.00	5443157.66	2.60	0	4000	70.0	70.0	0.0	0.0	65.8	18.0	-1.5	0.0	0.0	0.0	0.0	-0.0	-12.3	-12.3
8	501222.00	5443157.66	2.60	0	8000	77.7	77.7	0.0	0.0	65.8	64.1	-1.5	0.0	0.0	0.0	0.0	-0.0	-50.8	-50.8

Point Source, ISO 9613, Name: "MM_Inv2", ID: "MM_Inv2"																			
Nr.	X	Y	Z	Refl.	Freq.	LxT	LxN	K0	Dc	Adiv	Aatm	Agr	Afol	Ahous	Abar	Cmet	RL	LrT	LrN
	(m)	(m)	(m)		(Hz)	dB(A)	dB(A)	(dB)	(dB)	(dB)	(dB)	(dB)	(dB)	(dB)	(dB)	(dB)	(dB)	dB(A)	dB(A)
1	501240.10	5442978.46	2.60	0	63	68.1	68.1	0.0	0.0	68.2	0.1	-5.1	0.0	0.0	0.0	0.0	-0.0	4.9	4.9
2	501240.10	5442978.46	2.60	0	125	78.9	78.9	0.0	0.0	68.2	0.3	3.7	0.0	0.0	0.0	0.0	-0.0	6.6	6.6
3	501240.10	5442978.46	2.60	0	250	85.5	85.5	0.0	0.0	68.2	0.8	2.7	0.0	0.0	0.0	0.0	-0.0	13.8	13.8
4	501240.10	5442978.46	2.60	0	500	87.3	87.3	0.0	0.0	68.2	1.4	-1.1	0.0	0.0	0.0	0.0	-0.0	18.8	18.8
5	501240.10	5442978.46	2.60	0	1000	83.7	83.7	0.0	0.0	68.2	2.7	-1.5	0.0	0.0	0.0	0.0	-0.0	14.4	14.4
6	501240.10	5442978.46	2.60	0	2000	79.1	79.1	0.0	0.0	68.2	7.0	-1.5	0.0	0.0	0.0	0.0	-0.0	5.4	5.4
7	501240.10	5442978.46	2.60	0	4000	70.0	70.0	0.0	0.0	68.2	23.8	-1.5	0.0	0.0	0.0	0.0	-0.0	-20.5	-20.5
8	501240.10	5442978.46	2.60	0	8000	77.7	77.7	0.0	0.0	68.2	84.9	-1.5	0.0	0.0	0.0	0.0	-0.0	-73.9	-73.9

Point Source, ISO 9613, Name: "MM_Inv3", ID: "MM_Inv3"																			
Nr.	X	Y	Z	Refl.	Freq.	LxT	LxN	K0	Dc	Adiv	Aatm	Agr	Afol	Ahous	Abar	Cmet	RL	LrT	LrN
	(m)	(m)	(m)		(Hz)	dB(A)	dB(A)	(dB)	(dB)	(dB)	(dB)	(dB)	(dB)	(dB)	(dB)	(dB)	(dB)	dB(A)	dB(A)
1	501240.10	5442776.86	2.60	0	63	68.1	68.1	0.0	0.0	70.3	0.1	-5.3	0.0	0.0	0.0	0.0	-0.0	3.0	3.0
2	501240.10	5442776.86	2.60	0	125	78.9	78.9	0.0	0.0	70.3	0.4	4.0	0.0	0.0	0.0	0.0	-0.0	4.2	4.2
3	501240.10	5442776.86	2.60	0	250	85.5	85.5	0.0	0.0	70.3	1.0	2.7	0.0	0.0	0.0	0.0	-0.0	11.6	11.6
4	501240.10	5442776.86	2.60	0	500	87.3	87.3	0.0	0.0	70.3	1.8	-1.2	0.0	0.0	0.0	0.0	-0.0	16.4	16.4
5	501240.10	5442776.86	2.60	0	1000	83.7	83.7	0.0	0.0	70.3	3.4	-1.6	0.0	0.0	0.0	0.0	-0.0	11.6	11.6
6	501240.10	5442776.86	2.60	0	2000	79.1	79.1	0.0	0.0	70.3	8.9	-1.6	0.0	0.0	0.0	0.0	-0.0	1.5	1.5
7	501240.10	5442776.86	2.60	0	4000	70.0	70.0	0.0	0.0	70.3	30.2	-1.6	0.0	0.0	0.0	0.0	-0.0	-28.9	-28.9
8	501240.10	5442776.86	2.60	0	8000	77.7	77.7	0.0	0.0	70.3	107.9	-1.6	0.0	0.0	0.0	0.0	-0.0	-98.9	-98.9

Point Source, ISO 9613, Name: "MM_Inv4", ID: "MM_Inv4"																			
Nr.	X	Y	Z	Refl.	Freq.	LxT	LxN	K0	Dc	Adiv	Aatm	Agr	Afol	Ahous	Abar	Cmet	RL	LrT	LrN
	(m)	(m)	(m)		(Hz)	dB(A)	dB(A)	(dB)	(dB)	(dB)	(dB)	(dB)	(dB)	(dB)	(dB)	(dB)	(dB)	dB(A)	dB(A)
1	501240.10	5442575.26	2.60	0	63	68.1	68.1	0.0	0.0	72.0	0.1	-5.4	0.0	0.0	0.0	0.0	-0.0	1.4	1.4
2	501240.10	5442575.26	2.60	0	125	78.9	78.9	0.0	0.0	72.0	0.5	4.2	0.0	0.0	0.0	0.0	-0.0	2.3	2.3
3	501240.10	5442575.26	2.60	0	250	85.5	85.5	0.0	0.0	72.0	1.2	2.6	0.0	0.0	0.0	0.0	-0.0	9.7	9.7
4	501240.10	5442575.26	2.60	0	500	87.3	87.3	0.0	0.0	72.0	2.2	-1.2	0.0	0.0	0.0	0.0	-0.0	14.3	14.3
5	501240.10	5442575.26	2.60	0	1000	83.7	83.7	0.0	0.0	72.0	4.1	-1.6	0.0	0.0	0.0	0.0	-0.0	9.2	9.2
6	501240.10	5442575.26	2.60	0	2000	79.1	79.1	0.0	0.0	72.0	10.8	-1.6	0.0	0.0	0.0	0.0	-0.0	-2.1	-2.1
7	501240.10	5442575.26	2.60	0	4000	70.0	70.0	0.0	0.0	72.0	36.7	-1.6	0.0	0.0	0.0	0.0	-0.0	-37.1	-37.1
8	501240.10	5442575.26	2.60	0	8000	77.7	77.7	0.0	0.0	72.0	131.1	-1.6	0.0	0.0	0.0	0.0	-0.0	-123.7	-123.7

Point Source, ISO 9613, Name: "MM_Inv5", ID: "MM_Inv5"																			
Nr.	X	Y	Z	Refl.	Freq.	LxT	LxN	K0	Dc	Adiv	Aatm	Agr	Afol	Ahous	Abar	Cmet	RL	LrT	LrN
	(m)	(m)	(m)		(Hz)	dB(A)	dB(A)	(dB)	(dB)	(dB)	(dB)	(dB)	(dB)	(dB)	(dB)	(dB)	(dB)	dB(A)	dB(A)
1	500977.67	5442553.91	2.60	0	63	68.1	68.1	0.0	0.0	72.1	0.1	-5.4	0.0	0.0	0.0	0.0	-0.0	1.3	1.3
2	500977.67	5442553.91	2.60	0	125	78.9	78.9	0.0	0.0	72.1	0.5	4.2	0.0	0.0	0.0	0.0	-0.0	2.2	2.2
3	500977.67	5442553.91	2.60	0	250	85.5	85.5	0.0	0.0	72.1	1.2	2.6	0.0	0.0	0.0	0.0	-0.0	9.6	9.6
4	500977.67	5442553.91	2.60	0	500	87.3	87.3	0.0	0.0	72.1	2.2	-1.2	0.0	0.0	0.0	0.0	-0.0	14.2	14.2
5	500977.67	5442553.91	2.60	0	1000	83.7	83.7	0.0	0.0	72.1	4.1	-1.6	0.0	0.0	0.0	0.0	-0.0	9.1	9.1
6	500977.67	5442553.91	2.60	0	2000	79.1	79.1	0.0	0.0	72.1	10.9	-1.6	0.0	0.0	0.0	0.0	-0.0	-2.3	-2.3
7	500977.67	5442553.91	2.60	0	4000	70.0	70.0	0.0	0.0	72.1	37.1	-1.6	0.0	0.0	0.0	0.0	-0.0	-37.5	-37.5
8	500977.67	5442553.91	2.60	0	8000	77.7	77.7	0.0	0.0	72.1	132.2	-1.6	0.0	0.0	0.0	0.0	-0.0	-125.0	-125.0

Point Source, ISO 9613, Name: "MM_Inv6", ID: "MM_Inv6"																			
Nr.	X	Y	Z	Refl.	Freq.	LxT	LxN	K0	Dc	Adiv	Aatm	Agr	Afol	Ahous	Abar	Cmet	RL	LrT	LrN
	(m)	(m)	(m)		(Hz)	dB(A)	dB(A)	(dB)	(dB)	(dB)	(dB)	(dB)	(dB)	(dB)	(dB)	(dB)	(dB)	dB(A)	dB(A)
1	500977.67	5442755.51	2.60	0	63	68.1	68.1	0.0	0.0	70.4	0.1	-5.3	0.0	0.0	0.0	0.0	-0.0	2.9	2.9
2	500977.67	5442755.51	2.60	0	125	78.9	78.9	0.0	0.0	70.4	0.4	4.1	0.0	0.0	0.0	0.0	-0.0	4.1	4.1
3	500977.67	5442755.51	2.60	0	250	85.5	85.5	0.0	0.0	70.4	1.0	2.7	0.0	0.0	0.0	0.0	-0.0	11.5	11.5
4	500977.67	5442755.51	2.60	0	500	87.3	87.3	0.0	0.0	70.4	1.8	-1.2	0.0	0.0	0.0	0.0	-0.0	16.3	16.3
5	500977.67	5442755.51	2.60	0	1000	83.7	83.7	0.0	0.0	70.4	3.4	-1.6	0.0	0.0	0.0	0.0	-0.0	11.5	11.5
6	500977.67	5442755.51	2.60	0	2000	79.1	79.1	0.0	0.0	70.4	9.0	-1.6	0.0	0.0	0.0	0.0	-0.0	1.3	1.3
7	500977.67	5442755.51	2.60	0	4000	70.0	70.0	0.0	0.0	70.4	30.5	-1.6	0.0	0.0	0.0	0.0	-0.0	-29.3	-29.3
8	500977.67	5442755.51	2.60	0	8000	77.7	77.7	0.0	0.0	70.4	108.7	-1.6	0.0	0.0	0.0	0.0	-0.0	-99.8	-99.8

Point Source, ISO 9613, Name: "MM_Inv7", ID: "MM_Inv7"																			
Nr.	X	Y	Z	Refl.	Freq.	LxT	LxN	K0	Dc	Adiv	Aatm	Agr	Afol	Ahous	Abar	Cmet	RL	LrT	LrN
	(m)	(m)	(m)		(Hz)	dB(A)	dB(A)	(dB)	(dB)	(dB)	(dB)	(dB)	(dB)	(dB)	(dB)	(dB)	(dB)	dB(A)	dB(A)
1	500977.67	5442957.06	2.60	0	63	68.1	68.1	0.0	0.0	68.3	0.1	-5.1	0.0	0.0	0.0	0.0	-0.0	4.9	4.9
2	500977.67	5442957.06	2.60	0	125	78.9	78.9	0.0	0.0	68.3	0.3	3.7	0.0	0.0	0.0	0.0	-0.0	6.6	6.6
3	500977.67	5442957.06	2.60	0	250	85.5	85.5	0.0	0.0	68.3	0.8	2.7	0.0	0.0	0.0	0.0	-0.0	13.8	13.8

Point Source, ISO 9613, Name: "MM_Inv7", ID: "MM_Inv7"																			
Nr.	X	Y	Z	Refl.	Freq.	LxT	LxN	K0	Dc	Adiv	Aatm	Agr	Afol	Ahous	Abar	Cmet	RL	LrT	LrN
	(m)	(m)	(m)		(Hz)	dB(A)	dB(A)	(dB)	(dB)	(dB)	(dB)	(dB)	(dB)	(dB)	(dB)	(dB)	(dB)	dB(A)	dB(A)
4	500977.67	5442957.06	2.60	0	500	87.3	87.3	0.0	0.0	68.3	1.4	-1.1	0.0	0.0	0.0	0.0	-0.0	18.7	18.7
5	500977.67	5442957.06	2.60	0	1000	83.7	83.7	0.0	0.0	68.3	2.7	-1.5	0.0	0.0	0.0	0.0	-0.0	14.3	14.3
6	500977.67	5442957.06	2.60	0	2000	79.1	79.1	0.0	0.0	68.3	7.0	-1.5	0.0	0.0	0.0	0.0	-0.0	5.3	5.3
7	500977.67	5442957.06	2.60	0	4000	70.0	70.0	0.0	0.0	68.3	23.9	-1.5	0.0	0.0	0.0	0.0	-0.0	-20.6	-20.6
8	500977.67	5442957.06	2.60	0	8000	77.7	77.7	0.0	0.0	68.3	85.3	-1.5	0.0	0.0	0.0	0.0	-0.0	-74.3	-74.3

Point Source, ISO 9613, Name: "MM_Trans1", ID: "MM_Trans1"																			
Nr.	X	Y	Z	Refl.	Freq.	LxT	LxN	K0	Dc	Adiv	Aatm	Agr	Afol	Ahous	Abar	Cmet	RL	LrT	LrN
	(m)	(m)	(m)		(Hz)	dB(A)	dB(A)	(dB)	(dB)	(dB)	(dB)	(dB)	(dB)	(dB)	(dB)	(dB)	(dB)	dB(A)	dB(A)
1	501216.50	5443158.16	2.58	0	32	37.3	37.3	0.0	0.0	65.8	0.0	-4.8	0.0	0.0	0.0	0.0	-0.0	-23.6	-23.6
2	501216.50	5443158.16	2.58	0	63	56.5	56.5	0.0	0.0	65.8	0.1	-4.8	0.0	0.0	0.0	0.0	-0.0	-4.5	-4.5
3	501216.50	5443158.16	2.58	0	125	68.6	68.6	0.0	0.0	65.8	0.2	3.2	0.0	0.0	0.0	0.0	-0.0	-0.6	-0.6
4	501216.50	5443158.16	2.58	0	250	71.1	71.1	0.0	0.0	65.8	0.6	2.8	0.0	0.0	0.0	0.0	-0.0	2.0	2.0
5	501216.50	5443158.16	2.58	0	500	76.5	76.5	0.0	0.0	65.8	1.1	-1.0	0.0	0.0	0.0	0.0	-0.0	10.7	10.7
6	501216.50	5443158.16	2.58	0	1000	73.7	73.7	0.0	0.0	65.8	2.0	-1.4	0.0	0.0	0.0	0.0	-0.0	7.4	7.4
7	501216.50	5443158.16	2.58	0	2000	69.9	69.9	0.0	0.0	65.8	5.3	-1.5	0.0	0.0	0.0	0.0	-0.0	0.3	0.3
8	501216.50	5443158.16	2.58	0	4000	64.7	64.7	0.0	0.0	65.8	17.9	-1.5	0.0	0.0	0.0	0.0	-0.0	-17.5	-17.5
9	501216.50	5443158.16	2.58	0	8000	55.6	55.6	0.0	0.0	65.8	63.9	-1.5	0.0	0.0	0.0	0.0	-0.0	-72.6	-72.6

Point Source, ISO 9613, Name: "MM_Trans2", ID: "MM_Trans2"																			
Nr.	X	Y	Z	Refl.	Freq.	LxT	LxN	K0	Dc	Adiv	Aatm	Agr	Afol	Ahous	Abar	Cmet	RL	LrT	LrN
	(m)	(m)	(m)		(Hz)	dB(A)	dB(A)	(dB)	(dB)	(dB)	(dB)	(dB)	(dB)	(dB)	(dB)	(dB)	(dB)	dB(A)	dB(A)
1	501234.60	5442978.96	2.58	0	32	37.3	37.3	0.0	0.0	68.2	0.0	-5.1	0.0	0.0	0.0	0.0	-0.0	-25.8	-25.8
2	501234.60	5442978.96	2.58	0	63	56.5	56.5	0.0	0.0	68.2	0.1	-5.1	0.0	0.0	0.0	0.0	-0.0	-6.7	-6.7
3	501234.60	5442978.96	2.58	0	125	68.6	68.6	0.0	0.0	68.2	0.3	3.7	0.0	0.0	0.0	0.0	-0.0	-3.6	-3.6
4	501234.60	5442978.96	2.58	0	250	71.1	71.1	0.0	0.0	68.2	0.8	2.7	0.0	0.0	0.0	0.0	-0.0	-0.6	-0.6
5	501234.60	5442978.96	2.58	0	500	76.5	76.5	0.0	0.0	68.2	1.4	-1.1	0.0	0.0	0.0	0.0	-0.0	8.0	8.0
6	501234.60	5442978.96	2.58	0	1000	73.7	73.7	0.0	0.0	68.2	2.6	-1.5	0.0	0.0	0.0	0.0	-0.0	4.4	4.4
7	501234.60	5442978.96	2.58	0	2000	69.9	69.9	0.0	0.0	68.2	7.0	-1.5	0.0	0.0	0.0	0.0	-0.0	-3.8	-3.8
8	501234.60	5442978.96	2.58	0	4000	64.7	64.7	0.0	0.0	68.2	23.7	-1.5	0.0	0.0	0.0	0.0	-0.0	-25.7	-25.7
9	501234.60	5442978.96	2.58	0	8000	55.6	55.6	0.0	0.0	68.2	84.7	-1.5	0.0	0.0	0.0	0.0	-0.0	-95.7	-95.7

Point Source, ISO 9613, Name: "MM_Trans3", ID: "MM_Trans3"																			
Nr.	X	Y	Z	Refl.	Freq.	LxT	LxN	K0	Dc	Adiv	Aatm	Agr	Afol	Ahous	Abar	Cmet	RL	LrT	LrN
	(m)	(m)	(m)		(Hz)	dB(A)	dB(A)	(dB)	(dB)	(dB)	(dB)	(dB)	(dB)	(dB)	(dB)	(dB)	(dB)	dB(A)	dB(A)
1	501234.60	5442777.36	2.58	0	32	37.3	37.3	0.0	0.0	70.3	0.0	-5.3	0.0	0.0	0.0	0.0	-0.0	-27.7	-27.7
2	501234.60	5442777.36	2.58	0	63	56.5	56.5	0.0	0.0	70.3	0.1	-5.3	0.0	0.0	0.0	0.0	-0.0	-8.6	-8.6
3	501234.60	5442777.36	2.58	0	125	68.6	68.6	0.0	0.0	70.3	0.4	4.1	0.0	0.0	0.0	0.0	-0.0	-6.1	-6.1
4	501234.60	5442777.36	2.58	0	250	71.1	71.1	0.0	0.0	70.3	1.0	2.7	0.0	0.0	0.0	0.0	-0.0	-2.8	-2.8
5	501234.60	5442777.36	2.58	0	500	76.5	76.5	0.0	0.0	70.3	1.8	-1.1	0.0	0.0	0.0	0.0	-0.0	5.6	5.6
6	501234.60	5442777.36	2.58	0	1000	73.7	73.7	0.0	0.0	70.3	3.4	-1.6	0.0	0.0	0.0	0.0	-0.0	1.6	1.6
7	501234.60	5442777.36	2.58	0	2000	69.9	69.9	0.0	0.0	70.3	8.9	-1.6	0.0	0.0	0.0	0.0	-0.0	-7.7	-7.7
8	501234.60	5442777.36	2.58	0	4000	64.7	64.7	0.0	0.0	70.3	30.2	-1.6	0.0	0.0	0.0	0.0	-0.0	-34.2	-34.2
9	501234.60	5442777.36	2.58	0	8000	55.6	55.6	0.0	0.0	70.3	107.7	-1.6	0.0	0.0	0.0	0.0	-0.0	-120.8	-120.8

Point Source, ISO 9613, Name: "MM_Trans4", ID: "MM_Trans4"																			
Nr.	X	Y	Z	Refl.	Freq.	LxT	LxN	K0	Dc	Adiv	Aatm	Agr	Afol	Ahous	Abar	Cmet	RL	LrT	LrN
	(m)	(m)	(m)		(Hz)	dB(A)	dB(A)	(dB)	(dB)	(dB)	(dB)	(dB)	(dB)	(dB)	(dB)	(dB)	(dB)	dB(A)	dB(A)
1	501234.60	5442575.76	2.58	0	32	37.3	37.3	0.0	0.0	72.0	0.0	-5.4	0.0	0.0	0.0	0.0	-0.0	-29.3	-29.3
2	501234.60	5442575.76	2.58	0	63	56.5	56.5	0.0	0.0	72.0	0.1	-5.4	0.0	0.0	0.0	0.0	-0.0	-10.2	-10.2
3	501234.60	5442575.76	2.58	0	125	68.6	68.6	0.0	0.0	72.0	0.5	4.2	0.0	0.0	0.0	0.0	-0.0	-8.0	-8.0
4	501234.60	5442575.76	2.58	0	250	71.1	71.1	0.0	0.0	72.0	1.2	2.6	0.0	0.0	0.0	0.0	-0.0	-4.7	-4.7
5	501234.60	5442575.76	2.58	0	500	76.5	76.5	0.0	0.0	72.0	2.2	-1.2	0.0	0.0	0.0	0.0	-0.0	3.5	3.5
6	501234.60	5442575.76	2.58	0	1000	73.7	73.7	0.0	0.0	72.0	4.1	-1.6	0.0	0.0	0.0	0.0	-0.0	-0.8	-0.8
7	501234.60	5442575.76	2.58	0	2000	69.9	69.9	0.0	0.0	72.0	10.8	-1.6	0.0	0.0	0.0	0.0	-0.0	-11.3	-11.3
8	501234.60	5442575.76	2.58	0	4000	64.7	64.7	0.0	0.0	72.0	36.7	-1.6	0.0	0.0	0.0	0.0	-0.0	-42.3	-42.3
9	501234.60	5442575.76	2.58	0	8000	55.6	55.6	0.0	0.0	72.0	130.9	-1.6	0.0	0.0	0.0	0.0	-0.0	-145.7	-145.7

Point Source, ISO 9613, Name: "MM_Trans5", ID: "MM_Trans5"																			
Nr.	X	Y	Z	Refl.	Freq.	LxT	LxN	K0	Dc	Adiv	Aatm	Agr	Afol	Ahous	Abar	Cmet	RL	LrT	LrN
	(m)	(m)	(m)		(Hz)	dB(A)	dB(A)	(dB)	(dB)	(dB)	(dB)	(dB)	(dB)	(dB)	(dB)	(dB)	(dB)	dB(A)	dB(A)
1	500983.17	5442553.41	2.58	0	32	37.3	37.3	0.0	0.0	72.1	0.0	-5.4	0.0	0.0	0.0	0.0	-0.0	-29.4	-29.4
2	500983.17	5442553.41	2.58	0	63	56.5	56.5	0.0	0.0	72.1	0.1	-5.4	0.0	0.0	0.0	0.0	-0.0	-10.3	-10.3

Point Source, ISO 9613, Name: "MM_Trans5", ID: "MM_Trans5"																			
Nr.	X	Y	Z	Refl.	Freq.	LxT	LxN	K0	Dc	Adiv	Aatm	Agr	Afol	Ahous	Abar	Cmet	RL	LrT	LrN
	(m)	(m)	(m)		(Hz)	dB(A)	dB(A)	(dB)	(dB)	(dB)	(dB)	(dB)	(dB)	(dB)	(dB)	(dB)	(dB)	dB(A)	dB(A)
3	500983.17	5442553.41	2.58	0	125	68.6	68.6	0.0	0.0	72.1	0.5	4.2	0.0	0.0	0.0	0.0	-0.0	-8.1	-8.1
4	500983.17	5442553.41	2.58	0	250	71.1	71.1	0.0	0.0	72.1	1.2	2.6	0.0	0.0	0.0	0.0	-0.0	-4.8	-4.8
5	500983.17	5442553.41	2.58	0	500	76.5	76.5	0.0	0.0	72.1	2.2	-1.2	0.0	0.0	0.0	0.0	-0.0	3.4	3.4
6	500983.17	5442553.41	2.58	0	1000	73.7	73.7	0.0	0.0	72.1	4.1	-1.6	0.0	0.0	0.0	0.0	-0.0	-0.9	-0.9
7	500983.17	5442553.41	2.58	0	2000	69.9	69.9	0.0	0.0	72.1	10.9	-1.6	0.0	0.0	0.0	0.0	-0.0	-11.5	-11.5
8	500983.17	5442553.41	2.58	0	4000	64.7	64.7	0.0	0.0	72.1	37.1	-1.6	0.0	0.0	0.0	0.0	-0.0	-42.8	-42.8
9	500983.17	5442553.41	2.58	0	8000	55.6	55.6	0.0	0.0	72.1	132.2	-1.6	0.0	0.0	0.0	0.0	-0.0	-147.1	-147.1

Point Source, ISO 9613, Name: "MM_Trans6", ID: "MM_Trans6"																			
Nr.	X	Y	Z	Refl.	Freq.	LxT	LxN	K0	Dc	Adiv	Aatm	Agr	Afol	Ahous	Abar	Cmet	RL	LrT	LrN
	(m)	(m)	(m)		(Hz)	dB(A)	dB(A)	(dB)	(dB)	(dB)	(dB)	(dB)	(dB)	(dB)	(dB)	(dB)	(dB)	dB(A)	dB(A)
1	500983.17	5442755.01	2.58	0	32	37.3	37.3	0.0	0.0	70.4	0.0	-5.3	0.0	0.0	0.0	0.0	-0.0	-27.8	-27.8
2	500983.17	5442755.01	2.58	0	63	56.5	56.5	0.0	0.0	70.4	0.1	-5.3	0.0	0.0	0.0	0.0	-0.0	-8.7	-8.7
3	500983.17	5442755.01	2.58	0	125	68.6	68.6	0.0	0.0	70.4	0.4	4.1	0.0	0.0	0.0	0.0	-0.0	-6.2	-6.2
4	500983.17	5442755.01	2.58	0	250	71.1	71.1	0.0	0.0	70.4	1.0	2.7	0.0	0.0	0.0	0.0	-0.0	-2.9	-2.9
5	500983.17	5442755.01	2.58	0	500	76.5	76.5	0.0	0.0	70.4	1.8	-1.1	0.0	0.0	0.0	0.0	-0.0	5.5	5.5
6	500983.17	5442755.01	2.58	0	1000	73.7	73.7	0.0	0.0	70.4	3.4	-1.6	0.0	0.0	0.0	0.0	-0.0	1.5	1.5
7	500983.17	5442755.01	2.58	0	2000	69.9	69.9	0.0	0.0	70.4	9.0	-1.6	0.0	0.0	0.0	0.0	-0.0	-7.9	-7.9
8	500983.17	5442755.01	2.58	0	4000	64.7	64.7	0.0	0.0	70.4	30.5	-1.6	0.0	0.0	0.0	0.0	-0.0	-34.6	-34.6
9	500983.17	5442755.01	2.58	0	8000	55.6	55.6	0.0	0.0	70.4	108.7	-1.6	0.0	0.0	0.0	0.0	-0.0	-121.9	-121.9

Point Source, ISO 9613, Name: "MM_Trans7", ID: "MM_Trans7"																			
Nr.	X	Y	Z	Refl.	Freq.	LxT	LxN	K0	Dc	Adiv	Aatm	Agr	Afol	Ahous	Abar	Cmet	RL	LrT	LrN
	(m)	(m)	(m)		(Hz)	dB(A)	dB(A)	(dB)	(dB)	(dB)	(dB)	(dB)	(dB)	(dB)	(dB)	(dB)	(dB)	dB(A)	dB(A)
1	500983.17	5442956.56	2.58	0	32	37.3	37.3	0.0	0.0	68.3	0.0	-5.1	0.0	0.0	0.0	0.0	-0.0	-25.9	-25.9
2	500983.17	5442956.56	2.58	0	63	56.5	56.5	0.0	0.0	68.3	0.1	-5.1	0.0	0.0	0.0	0.0	-0.0	-6.7	-6.7
3	500983.17	5442956.56	2.58	0	125	68.6	68.6	0.0	0.0	68.3	0.3	3.7	0.0	0.0	0.0	0.0	-0.0	-3.7	-3.7
4	500983.17	5442956.56	2.58	0	250	71.1	71.1	0.0	0.0	68.3	0.8	2.7	0.0	0.0	0.0	0.0	-0.0	-0.7	-0.7
5	500983.17	5442956.56	2.58	0	500	76.5	76.5	0.0	0.0	68.3	1.4	-1.1	0.0	0.0	0.0	0.0	-0.0	7.9	7.9
6	500983.17	5442956.56	2.58	0	1000	73.7	73.7	0.0	0.0	68.3	2.7	-1.5	0.0	0.0	0.0	0.0	-0.0	4.3	4.3
7	500983.17	5442956.56	2.58	0	2000	69.9	69.9	0.0	0.0	68.3	7.0	-1.5	0.0	0.0	0.0	0.0	-0.0	-3.9	-3.9
8	500983.17	5442956.56	2.58	0	4000	64.7	64.7	0.0	0.0	68.3	23.9	-1.5	0.0	0.0	0.0	0.0	-0.0	-25.9	-25.9
9	500983.17	5442956.56	2.58	0	8000	55.6	55.6	0.0	0.0	68.3	85.3	-1.5	0.0	0.0	0.0	0.0	-0.0	-96.4	-96.4

Receiver

Name: 45_R42

ID: 45_R42

X: 501792.22

Y: 5443590.25

Z: 4.50

Point Source, ISO 9613, Name: "Ab_Sub115", ID: "Ab_Sub115"

Nr.	X (m)	Y (m)	Z (m)	Refl.	Freq. (Hz)	LxT dB(A)	LxN dB(A)	K0 (dB)	Dc (dB)	Adiv (dB)	Aatm (dB)	Agr (dB)	Afol (dB)	Ahous (dB)	Abar (dB)	Cmet (dB)	RL (dB)	LrT dB(A)	LrN dB(A)
1	501008.63	5443536.29	3.60	0	32	43.3	43.3	0.0	0.0	68.9	0.0	-5.1	0.0	0.0	0.0	0.0	-0.0	-20.6	-20.6
2	501008.63	5443536.29	3.60	0	63	60.5	60.5	0.0	0.0	68.9	0.1	-5.1	0.0	0.0	0.0	0.0	-0.0	-3.4	-3.4
3	501008.63	5443536.29	3.60	0	125	73.6	73.6	0.0	0.0	68.9	0.3	3.7	0.0	0.0	0.0	0.0	-0.0	0.7	0.7
4	501008.63	5443536.29	3.60	0	250	79.1	79.1	0.0	0.0	68.9	0.8	1.3	0.0	0.0	0.0	0.0	-0.0	8.1	8.1
5	501008.63	5443536.29	3.60	0	500	84.5	84.5	0.0	0.0	68.9	1.5	-1.5	0.0	0.0	0.0	0.0	-0.0	15.6	15.6
6	501008.63	5443536.29	3.60	0	1000	81.7	81.7	0.0	0.0	68.9	2.9	-1.5	0.0	0.0	0.0	0.0	-0.0	11.5	11.5
7	501008.63	5443536.29	3.60	0	2000	77.9	77.9	0.0	0.0	68.9	7.6	-1.5	0.0	0.0	0.0	0.0	-0.0	2.9	2.9
8	501008.63	5443536.29	3.60	0	4000	72.7	72.7	0.0	0.0	68.9	25.7	-1.5	0.0	0.0	0.0	0.0	-0.0	-20.4	-20.4
9	501008.63	5443536.29	3.60	0	8000	62.6	62.6	0.0	0.0	68.9	91.8	-1.5	0.0	0.0	0.0	0.0	-0.0	-96.6	-96.6

Point Source, ISO 9613, Name: "Ab_Inv1", ID: "Ab_Inv1"

Nr.	X (m)	Y (m)	Z (m)	Refl.	Freq. (Hz)	LxT dB(A)	LxN dB(A)	K0 (dB)	Dc (dB)	Adiv (dB)	Aatm (dB)	Agr (dB)	Afol (dB)	Ahous (dB)	Abar (dB)	Cmet (dB)	RL (dB)	LrT dB(A)	LrN dB(A)
1	501813.68	5442663.24	2.60	0	63	68.1	68.1	0.0	0.0	70.3	0.1	-5.3	0.0	0.0	0.0	0.0	-0.0	2.9	2.9
2	501813.68	5442663.24	2.60	0	125	78.9	78.9	0.0	0.0	70.3	0.4	4.1	0.0	0.0	0.0	0.0	-0.0	4.1	4.1
3	501813.68	5442663.24	2.60	0	250	85.5	85.5	0.0	0.0	70.3	1.0	2.7	0.0	0.0	0.0	0.0	-0.0	11.5	11.5
4	501813.68	5442663.24	2.60	0	500	87.3	87.3	0.0	0.0	70.3	1.8	-1.2	0.0	0.0	0.0	0.0	-0.0	16.3	16.3
5	501813.68	5442663.24	2.60	0	1000	83.7	83.7	0.0	0.0	70.3	3.4	-1.6	0.0	0.0	0.0	0.0	-0.0	11.6	11.6
6	501813.68	5442663.24	2.60	0	2000	79.1	79.1	0.0	0.0	70.3	9.0	-1.6	0.0	0.0	0.0	0.0	-0.0	1.4	1.4
7	501813.68	5442663.24	2.60	0	4000	70.0	70.0	0.0	0.0	70.3	30.4	-1.6	0.0	0.0	0.0	0.0	-0.0	-29.1	-29.1
8	501813.68	5442663.24	2.60	0	8000	77.7	77.7	0.0	0.0	70.3	108.4	-1.6	0.0	0.0	0.0	0.0	-0.0	-99.4	-99.4

Point Source, ISO 9613, Name: "Ab_Inv2", ID: "Ab_Inv2"

Nr.	X (m)	Y (m)	Z (m)	Refl.	Freq. (Hz)	LxT dB(A)	LxN dB(A)	K0 (dB)	Dc (dB)	Adiv (dB)	Aatm (dB)	Agr (dB)	Afol (dB)	Ahous (dB)	Abar (dB)	Cmet (dB)	RL (dB)	LrT dB(A)	LrN dB(A)
1	501813.68	5442842.44	2.60	0	63	68.1	68.1	0.0	0.0	68.5	0.1	-5.1	0.0	0.0	0.0	0.0	-0.0	4.7	4.7
2	501813.68	5442842.44	2.60	0	125	78.9	78.9	0.0	0.0	68.5	0.3	3.8	0.0	0.0	0.0	0.0	-0.0	6.3	6.3
3	501813.68	5442842.44	2.60	0	250	85.5	85.5	0.0	0.0	68.5	0.8	2.7	0.0	0.0	0.0	0.0	-0.0	13.5	13.5
4	501813.68	5442842.44	2.60	0	500	87.3	87.3	0.0	0.0	68.5	1.4	-1.1	0.0	0.0	0.0	0.0	-0.0	18.5	18.5
5	501813.68	5442842.44	2.60	0	1000	83.7	83.7	0.0	0.0	68.5	2.7	-1.5	0.0	0.0	0.0	0.0	-0.0	14.0	14.0
6	501813.68	5442842.44	2.60	0	2000	79.1	79.1	0.0	0.0	68.5	7.2	-1.5	0.0	0.0	0.0	0.0	-0.0	4.9	4.9
7	501813.68	5442842.44	2.60	0	4000	70.0	70.0	0.0	0.0	68.5	24.5	-1.5	0.0	0.0	0.0	0.0	-0.0	-21.4	-21.4
8	501813.68	5442842.44	2.60	0	8000	77.7	77.7	0.0	0.0	68.5	87.4	-1.5	0.0	0.0	0.0	0.0	-0.0	-76.7	-76.7

Point Source, ISO 9613, Name: "Ab_Inv3", ID: "Ab_Inv3"

Nr.	X (m)	Y (m)	Z (m)	Refl.	Freq. (Hz)	LxT dB(A)	LxN dB(A)	K0 (dB)	Dc (dB)	Adiv (dB)	Aatm (dB)	Agr (dB)	Afol (dB)	Ahous (dB)	Abar (dB)	Cmet (dB)	RL (dB)	LrT dB(A)	LrN dB(A)
1	501813.58	5443021.64	2.60	0	63	68.1	68.1	0.0	0.0	66.1	0.1	-4.9	0.0	0.0	0.0	0.0	-0.0	6.8	6.8
2	501813.58	5443021.64	2.60	0	125	78.9	78.9	0.0	0.0	66.1	0.2	3.3	0.0	0.0	0.0	0.0	-0.0	9.3	9.3
3	501813.58	5443021.64	2.60	0	250	85.5	85.5	0.0	0.0	66.1	0.6	2.8	0.0	0.0	0.0	0.0	-0.0	16.0	16.0
4	501813.58	5443021.64	2.60	0	500	87.3	87.3	0.0	0.0	66.1	1.1	-1.0	0.0	0.0	0.0	0.0	-0.0	21.1	21.1
5	501813.58	5443021.64	2.60	0	1000	83.7	83.7	0.0	0.0	66.1	2.1	-1.5	0.0	0.0	0.0	0.0	-0.0	17.0	17.0
6	501813.58	5443021.64	2.60	0	2000	79.1	79.1	0.0	0.0	66.1	5.5	-1.5	0.0	0.0	0.0	0.0	-0.0	9.0	9.0
7	501813.58	5443021.64	2.60	0	4000	70.0	70.0	0.0	0.0	66.1	18.7	-1.5	0.0	0.0	0.0	0.0	-0.0	-13.3	-13.3
8	501813.58	5443021.64	2.60	0	8000	77.7	77.7	0.0	0.0	66.1	66.5	-1.5	0.0	0.0	0.0	0.0	-0.0	-53.4	-53.4

Point Source, ISO 9613, Name: "Ab_Inv4", ID: "Ab_Inv4"

Nr.	X (m)	Y (m)	Z (m)	Refl.	Freq. (Hz)	LxT dB(A)	LxN dB(A)	K0 (dB)	Dc (dB)	Adiv (dB)	Aatm (dB)	Agr (dB)	Afol (dB)	Ahous (dB)	Abar (dB)	Cmet (dB)	RL (dB)	LrT dB(A)	LrN dB(A)
1	501813.68	5443200.84	2.60	0	63	68.1	68.1	0.0	0.0	62.8	0.1	-4.4	0.0	0.0	0.0	0.0	-0.0	9.6	9.6
2	501813.68	5443200.84	2.60	0	125	78.9	78.9	0.0	0.0	62.8	0.2	2.8	0.0	0.0	0.0	0.0	-0.0	13.2	13.2
3	501813.68	5443200.84	2.60	0	250	85.5	85.5	0.0	0.0	62.8	0.4	2.9	0.0	0.0	0.0	0.0	-0.0	19.3	19.3
4	501813.68	5443200.84	2.60	0	500	87.3	87.3	0.0	0.0	62.8	0.8	-0.9	0.0	0.0	0.0	0.0	-0.0	24.6	24.6

Point Source, ISO 9613, Name: "Ab_Inv4", ID: "Ab_Inv4"																			
Nr.	X	Y	Z	Refl.	Freq.	LxT	LxN	K0	Dc	Adiv	Aatm	Agr	Afol	Ahous	Abar	Cmet	RL	LrT	LrN
	(m)	(m)	(m)		(Hz)	dB(A)	dB(A)	(dB)	(dB)	(dB)	(dB)	(dB)	(dB)	(dB)	(dB)	(dB)	(dB)	dB(A)	dB(A)
5	501813.68	5443200.84	2.60	0	1000	83.7	83.7	0.0	0.0	62.8	1.4	-1.3	0.0	0.0	0.0	0.0	-0.0	20.8	20.8
6	501813.68	5443200.84	2.60	0	2000	79.1	79.1	0.0	0.0	62.8	3.8	-1.3	0.0	0.0	0.0	0.0	-0.0	13.8	13.8
7	501813.68	5443200.84	2.60	0	4000	70.0	70.0	0.0	0.0	62.8	12.8	-1.3	0.0	0.0	0.0	0.0	-0.0	-4.3	-4.3
8	501813.68	5443200.84	2.60	0	8000	77.7	77.7	0.0	0.0	62.8	45.6	-1.3	0.0	0.0	0.0	0.0	-0.0	-29.4	-29.4

Point Source, ISO 9613, Name: "Ab_Inv5", ID: "Ab_Inv5"																			
Nr.	X	Y	Z	Refl.	Freq.	LxT	LxN	K0	Dc	Adiv	Aatm	Agr	Afol	Ahous	Abar	Cmet	RL	LrT	LrN
	(m)	(m)	(m)		(Hz)	dB(A)	dB(A)	(dB)	(dB)	(dB)	(dB)	(dB)	(dB)	(dB)	(dB)	(dB)	(dB)	dB(A)	dB(A)
1	502235.01	5442875.04	2.60	0	63	68.1	68.1	0.0	0.0	69.5	0.1	-5.2	0.0	0.0	0.0	0.0	-0.0	3.7	3.7
2	502235.01	5442875.04	2.60	0	125	78.9	78.9	0.0	0.0	69.5	0.4	3.9	0.0	0.0	0.0	0.0	-0.0	5.1	5.1
3	502235.01	5442875.04	2.60	0	250	85.5	85.5	0.0	0.0	69.5	0.9	2.7	0.0	0.0	0.0	0.0	-0.0	12.5	12.5
4	502235.01	5442875.04	2.60	0	500	87.3	87.3	0.0	0.0	69.5	1.6	-1.1	0.0	0.0	0.0	0.0	-0.0	17.3	17.3
5	502235.01	5442875.04	2.60	0	1000	83.7	83.7	0.0	0.0	69.5	3.1	-1.6	0.0	0.0	0.0	0.0	-0.0	12.7	12.7
6	502235.01	5442875.04	2.60	0	2000	79.1	79.1	0.0	0.0	69.5	8.1	-1.6	0.0	0.0	0.0	0.0	-0.0	3.0	3.0
7	502235.01	5442875.04	2.60	0	4000	70.0	70.0	0.0	0.0	69.5	27.6	-1.6	0.0	0.0	0.0	0.0	-0.0	-25.5	-25.5
8	502235.01	5442875.04	2.60	0	8000	77.7	77.7	0.0	0.0	69.5	98.3	-1.6	0.0	0.0	0.0	0.0	-0.0	-88.5	-88.5

Point Source, ISO 9613, Name: "Ab_Inv6", ID: "Ab_Inv6"																			
Nr.	X	Y	Z	Refl.	Freq.	LxT	LxN	K0	Dc	Adiv	Aatm	Agr	Afol	Ahous	Abar	Cmet	RL	LrT	LrN
	(m)	(m)	(m)		(Hz)	dB(A)	dB(A)	(dB)	(dB)	(dB)	(dB)	(dB)	(dB)	(dB)	(dB)	(dB)	(dB)	dB(A)	dB(A)
1	502235.01	5443065.44	2.60	0	63	68.1	68.1	0.0	0.0	67.7	0.1	-5.1	0.0	0.0	0.0	0.0	-0.0	5.3	5.3
2	502235.01	5443065.44	2.60	0	125	78.9	78.9	0.0	0.0	67.7	0.3	3.6	0.0	0.0	0.0	0.0	-0.0	7.3	7.3
3	502235.01	5443065.44	2.60	0	250	85.5	85.5	0.0	0.0	67.7	0.7	2.7	0.0	0.0	0.0	0.0	-0.0	14.3	14.3
4	502235.01	5443065.44	2.60	0	500	87.3	87.3	0.0	0.0	67.7	1.3	-1.1	0.0	0.0	0.0	0.0	-0.0	19.3	19.3
5	502235.01	5443065.44	2.60	0	1000	83.7	83.7	0.0	0.0	67.7	2.5	-1.5	0.0	0.0	0.0	0.0	-0.0	15.0	15.0
6	502235.01	5443065.44	2.60	0	2000	79.1	79.1	0.0	0.0	67.7	6.6	-1.5	0.0	0.0	0.0	0.0	-0.0	6.3	6.3
7	502235.01	5443065.44	2.60	0	4000	70.0	70.0	0.0	0.0	67.7	22.5	-1.5	0.0	0.0	0.0	0.0	-0.0	-18.7	-18.7
8	502235.01	5443065.44	2.60	0	8000	77.7	77.7	0.0	0.0	67.7	80.3	-1.5	0.0	0.0	0.0	0.0	-0.0	-68.8	-68.8

Point Source, ISO 9613, Name: "Ab_Inv7", ID: "Ab_Inv7"																			
Nr.	X	Y	Z	Refl.	Freq.	LxT	LxN	K0	Dc	Adiv	Aatm	Agr	Afol	Ahous	Abar	Cmet	RL	LrT	LrN
	(m)	(m)	(m)		(Hz)	dB(A)	dB(A)	(dB)	(dB)	(dB)	(dB)	(dB)	(dB)	(dB)	(dB)	(dB)	(dB)	dB(A)	dB(A)
1	502235.01	5443257.84	2.60	0	63	68.1	68.1	0.0	0.0	65.9	0.1	-4.8	0.0	0.0	0.0	0.0	-0.0	7.0	7.0
2	502235.01	5443257.84	2.60	0	125	78.9	78.9	0.0	0.0	65.9	0.2	3.3	0.0	0.0	0.0	0.0	-0.0	9.6	9.6
3	502235.01	5443257.84	2.60	0	250	85.5	85.5	0.0	0.0	65.9	0.6	2.8	0.0	0.0	0.0	0.0	-0.0	16.3	16.3
4	502235.01	5443257.84	2.60	0	500	87.3	87.3	0.0	0.0	65.9	1.1	-1.0	0.0	0.0	0.0	0.0	-0.0	21.4	21.4
5	502235.01	5443257.84	2.60	0	1000	83.7	83.7	0.0	0.0	65.9	2.0	-1.5	0.0	0.0	0.0	0.0	-0.0	17.3	17.3
6	502235.01	5443257.84	2.60	0	2000	79.1	79.1	0.0	0.0	65.9	5.3	-1.5	0.0	0.0	0.0	0.0	-0.0	9.3	9.3
7	502235.01	5443257.84	2.60	0	4000	70.0	70.0	0.0	0.0	65.9	18.1	-1.5	0.0	0.0	0.0	0.0	-0.0	-12.6	-12.6
8	502235.01	5443257.84	2.60	0	8000	77.7	77.7	0.0	0.0	65.9	64.7	-1.5	0.0	0.0	0.0	0.0	-0.0	-51.4	-51.4

Point Source, ISO 9613, Name: "Ab_Trans1", ID: "Ab_Trans1"																			
Nr.	X	Y	Z	Refl.	Freq.	LxT	LxN	K0	Dc	Adiv	Aatm	Agr	Afol	Ahous	Abar	Cmet	RL	LrT	LrN
	(m)	(m)	(m)		(Hz)	dB(A)	dB(A)	(dB)	(dB)	(dB)	(dB)	(dB)	(dB)	(dB)	(dB)	(dB)	(dB)	dB(A)	dB(A)
1	501819.18	5442662.74	2.58	0	32	37.3	37.3	0.0	0.0	70.3	0.0	-5.3	0.0	0.0	0.0	0.0	-0.0	-27.8	-27.8
2	501819.18	5442662.74	2.58	0	63	56.5	56.5	0.0	0.0	70.3	0.1	-5.3	0.0	0.0	0.0	0.0	-0.0	-8.7	-8.7
3	501819.18	5442662.74	2.58	0	125	68.6	68.6	0.0	0.0	70.3	0.4	4.1	0.0	0.0	0.0	0.0	-0.0	-6.2	-6.2
4	501819.18	5442662.74	2.58	0	250	71.1	71.1	0.0	0.0	70.3	1.0	2.7	0.0	0.0	0.0	0.0	-0.0	-2.9	-2.9
5	501819.18	5442662.74	2.58	0	500	76.5	76.5	0.0	0.0	70.3	1.8	-1.1	0.0	0.0	0.0	0.0	-0.0	5.5	5.5
6	501819.18	5442662.74	2.58	0	1000	73.7	73.7	0.0	0.0	70.3	3.4	-1.6	0.0	0.0	0.0	0.0	-0.0	1.5	1.5
7	501819.18	5442662.74	2.58	0	2000	69.9	69.9	0.0	0.0	70.3	9.0	-1.6	0.0	0.0	0.0	0.0	-0.0	-7.8	-7.8
8	501819.18	5442662.74	2.58	0	4000	64.7	64.7	0.0	0.0	70.3	30.4	-1.6	0.0	0.0	0.0	0.0	-0.0	-34.5	-34.5
9	501819.18	5442662.74	2.58	0	8000	55.6	55.6	0.0	0.0	70.3	108.5	-1.6	0.0	0.0	0.0	0.0	-0.0	-121.6	-121.6

Point Source, ISO 9613, Name: "Ab_Trans2", ID: "Ab_Trans2"																			
Nr.	X	Y	Z	Refl.	Freq.	LxT	LxN	K0	Dc	Adiv	Aatm	Agr	Afol	Ahous	Abar	Cmet	RL	LrT	LrN
	(m)	(m)	(m)		(Hz)	dB(A)	dB(A)	(dB)	(dB)	(dB)	(dB)	(dB)	(dB)	(dB)	(dB)	(dB)	(dB)	dB(A)	dB(A)
1	501819.18	5442841.94	2.58	0	32	37.3	37.3	0.0	0.0	68.5	0.0	-5.1	0.0	0.0	0.0	0.0	-0.0	-26.1	-26.1
2	501819.18	5442841.94	2.58	0	63	56.5	56.5	0.0	0.0	68.5	0.1	-5.1	0.0	0.0	0.0	0.0	-0.0	-6.9	-6.9
3	501819.18	5442841.94	2.58	0	125	68.6	68.6	0.0	0.0	68.5	0.3	3.8	0.0	0.0	0.0	0.0	-0.0	-4.0	-4.0
4	501819.18	5442841.94	2.58	0	250	71.1	71.1	0.0	0.0	68.5	0.8	2.7	0.0	0.0	0.0	0.0	-0.0	-0.9	-0.9
5	501819.18	5442841.94	2.58	0	500	76.5	76.5	0.0	0.0	68.5	1.4	-1.1	0.0	0.0	0.0	0.0	-0.0	7.6	7.6
6	501819.18	5442841.94	2.58	0	1000	73.7	73.7	0.0	0.0	68.5	2.7	-1.5	0.0	0.0	0.0	0.0	-0.0	4.0	4.0

Point Source, ISO 9613, Name: "Ab_Trans2", ID: "Ab_Trans2"																			
Nr.	X	Y	Z	Refl.	Freq.	LxT	LxN	K0	Dc	Adiv	Aatm	Agr	Afol	Ahous	Abar	Cmet	RL	LrT	LrN
	(m)	(m)	(m)		(Hz)	dB(A)	dB(A)	(dB)	(dB)	(dB)	(dB)	(dB)	(dB)	(dB)	(dB)	(dB)	(dB)	dB(A)	dB(A)
7	501819.18	5442841.94	2.58	0	2000	69.9	69.9	0.0	0.0	68.5	7.2	-1.5	0.0	0.0	0.0	0.0	-0.0	-4.3	-4.3
8	501819.18	5442841.94	2.58	0	4000	64.7	64.7	0.0	0.0	68.5	24.5	-1.5	0.0	0.0	0.0	0.0	-0.0	-26.8	-26.8
9	501819.18	5442841.94	2.58	0	8000	55.6	55.6	0.0	0.0	68.5	87.5	-1.5	0.0	0.0	0.0	0.0	-0.0	-98.9	-98.9

Point Source, ISO 9613, Name: "Ab_Trans3", ID: "Ab_Trans3"																			
Nr.	X	Y	Z	Refl.	Freq.	LxT	LxN	K0	Dc	Adiv	Aatm	Agr	Afol	Ahous	Abar	Cmet	RL	LrT	LrN
	(m)	(m)	(m)		(Hz)	dB(A)	dB(A)	(dB)	(dB)	(dB)	(dB)	(dB)	(dB)	(dB)	(dB)	(dB)	(dB)	dB(A)	dB(A)
1	501819.08	5443021.14	2.58	0	32	37.3	37.3	0.0	0.0	66.1	0.0	-4.9	0.0	0.0	0.0	0.0	-0.0	-23.9	-23.9
2	501819.08	5443021.14	2.58	0	63	56.5	56.5	0.0	0.0	66.1	0.1	-4.9	0.0	0.0	0.0	0.0	-0.0	-4.8	-4.8
3	501819.08	5443021.14	2.58	0	125	68.6	68.6	0.0	0.0	66.1	0.2	3.3	0.0	0.0	0.0	0.0	-0.0	-1.1	-1.1
4	501819.08	5443021.14	2.58	0	250	71.1	71.1	0.0	0.0	66.1	0.6	2.8	0.0	0.0	0.0	0.0	-0.0	1.6	1.6
5	501819.08	5443021.14	2.58	0	500	76.5	76.5	0.0	0.0	66.1	1.1	-1.0	0.0	0.0	0.0	0.0	-0.0	10.3	10.3
6	501819.08	5443021.14	2.58	0	1000	73.7	73.7	0.0	0.0	66.1	2.1	-1.5	0.0	0.0	0.0	0.0	-0.0	7.0	7.0
7	501819.08	5443021.14	2.58	0	2000	69.9	69.9	0.0	0.0	66.1	5.5	-1.5	0.0	0.0	0.0	0.0	-0.0	-0.3	-0.3
8	501819.08	5443021.14	2.58	0	4000	64.7	64.7	0.0	0.0	66.1	18.7	-1.5	0.0	0.0	0.0	0.0	-0.0	-18.6	-18.6
9	501819.08	5443021.14	2.58	0	8000	55.6	55.6	0.0	0.0	66.1	66.6	-1.5	0.0	0.0	0.0	0.0	-0.0	-75.6	-75.6

Point Source, ISO 9613, Name: "Ab_Trans4", ID: "Ab_Trans4"																			
Nr.	X	Y	Z	Refl.	Freq.	LxT	LxN	K0	Dc	Adiv	Aatm	Agr	Afol	Ahous	Abar	Cmet	RL	LrT	LrN
	(m)	(m)	(m)		(Hz)	dB(A)	dB(A)	(dB)	(dB)	(dB)	(dB)	(dB)	(dB)	(dB)	(dB)	(dB)	(dB)	dB(A)	dB(A)
1	501819.18	5443200.34	2.58	0	32	37.3	37.3	0.0	0.0	62.8	0.0	-4.4	0.0	0.0	0.0	0.0	-0.0	-21.2	-21.2
2	501819.18	5443200.34	2.58	0	63	56.5	56.5	0.0	0.0	62.8	0.1	-4.4	0.0	0.0	0.0	0.0	-0.0	-2.0	-2.0
3	501819.18	5443200.34	2.58	0	125	68.6	68.6	0.0	0.0	62.8	0.2	2.8	0.0	0.0	0.0	0.0	-0.0	2.8	2.8
4	501819.18	5443200.34	2.58	0	250	71.1	71.1	0.0	0.0	62.8	0.4	3.0	0.0	0.0	0.0	0.0	-0.0	4.9	4.9
5	501819.18	5443200.34	2.58	0	500	76.5	76.5	0.0	0.0	62.8	0.8	-0.9	0.0	0.0	0.0	0.0	-0.0	13.8	13.8
6	501819.18	5443200.34	2.58	0	1000	73.7	73.7	0.0	0.0	62.8	1.4	-1.3	0.0	0.0	0.0	0.0	-0.0	10.7	10.7
7	501819.18	5443200.34	2.58	0	2000	69.9	69.9	0.0	0.0	62.8	3.8	-1.3	0.0	0.0	0.0	0.0	-0.0	4.6	4.6
8	501819.18	5443200.34	2.58	0	4000	64.7	64.7	0.0	0.0	62.8	12.8	-1.3	0.0	0.0	0.0	0.0	-0.0	-9.6	-9.6
9	501819.18	5443200.34	2.58	0	8000	55.6	55.6	0.0	0.0	62.8	45.7	-1.3	0.0	0.0	0.0	0.0	-0.0	-51.6	-51.6

Point Source, ISO 9613, Name: "Ab_Trans5", ID: "Ab_Trans5"																			
Nr.	X	Y	Z	Refl.	Freq.	LxT	LxN	K0	Dc	Adiv	Aatm	Agr	Afol	Ahous	Abar	Cmet	RL	LrT	LrN
	(m)	(m)	(m)		(Hz)	dB(A)	dB(A)	(dB)	(dB)	(dB)	(dB)	(dB)	(dB)	(dB)	(dB)	(dB)	(dB)	dB(A)	dB(A)
1	502229.51	5442875.54	2.58	0	32	37.3	37.3	0.0	0.0	69.5	0.0	-5.2	0.0	0.0	0.0	0.0	-0.0	-26.9	-26.9
2	502229.51	5442875.54	2.58	0	63	56.5	56.5	0.0	0.0	69.5	0.1	-5.2	0.0	0.0	0.0	0.0	-0.0	-7.8	-7.8
3	502229.51	5442875.54	2.58	0	125	68.6	68.6	0.0	0.0	69.5	0.3	3.9	0.0	0.0	0.0	0.0	-0.0	-5.1	-5.1
4	502229.51	5442875.54	2.58	0	250	71.1	71.1	0.0	0.0	69.5	0.9	2.7	0.0	0.0	0.0	0.0	-0.0	-2.0	-2.0
5	502229.51	5442875.54	2.58	0	500	76.5	76.5	0.0	0.0	69.5	1.6	-1.1	0.0	0.0	0.0	0.0	-0.0	6.5	6.5
6	502229.51	5442875.54	2.58	0	1000	73.7	73.7	0.0	0.0	69.5	3.1	-1.6	0.0	0.0	0.0	0.0	-0.0	2.7	2.7
7	502229.51	5442875.54	2.58	0	2000	69.9	69.9	0.0	0.0	69.5	8.1	-1.6	0.0	0.0	0.0	0.0	-0.0	-6.1	-6.1
8	502229.51	5442875.54	2.58	0	4000	64.7	64.7	0.0	0.0	69.5	27.5	-1.6	0.0	0.0	0.0	0.0	-0.0	-30.7	-30.7
9	502229.51	5442875.54	2.58	0	8000	55.6	55.6	0.0	0.0	69.5	97.9	-1.6	0.0	0.0	0.0	0.0	-0.0	-110.2	-110.2

Point Source, ISO 9613, Name: "Ab_Trans6", ID: "Ab_Trans6"																			
Nr.	X	Y	Z	Refl.	Freq.	LxT	LxN	K0	Dc	Adiv	Aatm	Agr	Afol	Ahous	Abar	Cmet	RL	LrT	LrN
	(m)	(m)	(m)		(Hz)	dB(A)	dB(A)	(dB)	(dB)	(dB)	(dB)	(dB)	(dB)	(dB)	(dB)	(dB)	(dB)	dB(A)	dB(A)
1	502229.51	5443065.94	2.58	0	32	37.3	37.3	0.0	0.0	67.7	0.0	-5.1	0.0	0.0	0.0	0.0	-0.0	-25.3	-25.3
2	502229.51	5443065.94	2.58	0	63	56.5	56.5	0.0	0.0	67.7	0.1	-5.1	0.0	0.0	0.0	0.0	-0.0	-6.2	-6.2
3	502229.51	5443065.94	2.58	0	125	68.6	68.6	0.0	0.0	67.7	0.3	3.6	0.0	0.0	0.0	0.0	-0.0	-3.0	-3.0
4	502229.51	5443065.94	2.58	0	250	71.1	71.1	0.0	0.0	67.7	0.7	2.8	0.0	0.0	0.0	0.0	-0.0	-0.1	-0.1
5	502229.51	5443065.94	2.58	0	500	76.5	76.5	0.0	0.0	67.7	1.3	-1.1	0.0	0.0	0.0	0.0	-0.0	8.6	8.6
6	502229.51	5443065.94	2.58	0	1000	73.7	73.7	0.0	0.0	67.7	2.5	-1.5	0.0	0.0	0.0	0.0	-0.0	5.0	5.0
7	502229.51	5443065.94	2.58	0	2000	69.9	69.9	0.0	0.0	67.7	6.6	-1.5	0.0	0.0	0.0	0.0	-0.0	-2.9	-2.9
8	502229.51	5443065.94	2.58	0	4000	64.7	64.7	0.0	0.0	67.7	22.4	-1.5	0.0	0.0	0.0	0.0	-0.0	-23.8	-23.8
9	502229.51	5443065.94	2.58	0	8000	55.6	55.6	0.0	0.0	67.7	79.8	-1.5	0.0	0.0	0.0	0.0	-0.0	-90.4	-90.4

Point Source, ISO 9613, Name: "Ab_Trans7", ID: "Ab_Trans7"																			
Nr.	X	Y	Z	Refl.	Freq.	LxT	LxN	K0	Dc	Adiv	Aatm	Agr	Afol	Ahous	Abar	Cmet	RL	LrT	LrN
	(m)	(m)	(m)		(Hz)	dB(A)	dB(A)	(dB)	(dB)	(dB)	(dB)	(dB)	(dB)	(dB)	(dB)	(dB)	(dB)	dB(A)	dB(A)
1	502229.51	5443258.34	2.58	0	32	37.3	37.3	0.0	0.0	65.8	0.0	-4.8	0.0	0.0	0.0	0.0	-0.0	-23.7	-23.7
2	502229.51	5443258.34	2.58	0	63	56.5	56.5	0.0	0.0	65.8	0.1	-4.8	0.0	0.0	0.0	0.0	-0.0	-4.5	-4.5
3	502229.51	5443258.34	2.58	0	125	68.6	68.6	0.0	0.0	65.8	0.2	3.2	0.0	0.0	0.0	0.0	-0.0	-0.7	-0.7
4	502229.51	5443258.34	2.58	0	250	71.1	71.1	0.0	0.0	65.8	0.6	2.8	0.0	0.0	0.0	0.0	-0.0	1.9	1.9

Point Source, ISO 9613, Name: "Ab_Trans7", ID: "Ab_Trans7"																			
Nr.	X	Y	Z	Refl.	Freq.	LxT	LxN	K0	Dc	Adiv	Aatm	Agr	Afol	Ahous	Abar	Cmet	RL	LrT	LrN
	(m)	(m)	(m)		(Hz)	dB(A)	dB(A)	(dB)	(dB)	(dB)	(dB)	(dB)	(dB)	(dB)	(dB)	(dB)	(dB)	dB(A)	dB(A)
5	502229.51	5443258.34	2.58	0	500	76.5	76.5	0.0	0.0	65.8	1.1	-1.0	0.0	0.0	0.0	0.0	-0.0	10.6	10.6
6	502229.51	5443258.34	2.58	0	1000	73.7	73.7	0.0	0.0	65.8	2.0	-1.4	0.0	0.0	0.0	0.0	-0.0	7.3	7.3
7	502229.51	5443258.34	2.58	0	2000	69.9	69.9	0.0	0.0	65.8	5.3	-1.5	0.0	0.0	0.0	0.0	-0.0	0.3	0.3
8	502229.51	5443258.34	2.58	0	4000	64.7	64.7	0.0	0.0	65.8	18.0	-1.5	0.0	0.0	0.0	0.0	-0.0	-17.6	-17.6
9	502229.51	5443258.34	2.58	0	8000	55.6	55.6	0.0	0.0	65.8	64.2	-1.5	0.0	0.0	0.0	0.0	-0.0	-72.9	-72.9

Point Source, ISO 9613, Name: "Em_Sub115", ID: "Em_Sub115"																			
Nr.	X	Y	Z	Refl.	Freq.	LxT	LxN	K0	Dc	Adiv	Aatm	Agr	Afol	Ahous	Abar	Cmet	RL	LrT	LrN
	(m)	(m)	(m)		(Hz)	dB(A)	dB(A)	(dB)	(dB)	(dB)	(dB)	(dB)	(dB)	(dB)	(dB)	(dB)	(dB)	dB(A)	dB(A)
1	500978.58	5443536.29	3.60	0	32	43.3	43.3	0.0	0.0	69.2	0.0	-5.1	0.0	0.0	0.0	0.0	-0.0	-20.9	-20.9
2	500978.58	5443536.29	3.60	0	63	60.5	60.5	0.0	0.0	69.2	0.1	-5.1	0.0	0.0	0.0	0.0	-0.0	-3.7	-3.7
3	500978.58	5443536.29	3.60	0	125	73.6	73.6	0.0	0.0	69.2	0.3	3.8	0.0	0.0	0.0	0.0	-0.0	0.3	0.3
4	500978.58	5443536.29	3.60	0	250	79.1	79.1	0.0	0.0	69.2	0.9	1.3	0.0	0.0	0.0	0.0	-0.0	7.7	7.7
5	500978.58	5443536.29	3.60	0	500	84.5	84.5	0.0	0.0	69.2	1.6	-1.5	0.0	0.0	0.0	0.0	-0.0	15.2	15.2
6	500978.58	5443536.29	3.60	0	1000	81.7	81.7	0.0	0.0	69.2	3.0	-1.5	0.0	0.0	0.0	0.0	-0.0	11.0	11.0
7	500978.58	5443536.29	3.60	0	2000	77.9	77.9	0.0	0.0	69.2	7.9	-1.5	0.0	0.0	0.0	0.0	-0.0	2.3	2.3
8	500978.58	5443536.29	3.60	0	4000	72.7	72.7	0.0	0.0	69.2	26.7	-1.5	0.0	0.0	0.0	0.0	-0.0	-21.7	-21.7
9	500978.58	5443536.29	3.60	0	8000	62.6	62.6	0.0	0.0	69.2	95.3	-1.5	0.0	0.0	0.0	0.0	-0.0	-100.4	-100.4

Point Source, ISO 9613, Name: "Em_Inv1", ID: "Em_Inv1"																			
Nr.	X	Y	Z	Refl.	Freq.	LxT	LxN	K0	Dc	Adiv	Aatm	Agr	Afol	Ahous	Abar	Cmet	RL	LrT	LrN
	(m)	(m)	(m)		(Hz)	dB(A)	dB(A)	(dB)	(dB)	(dB)	(dB)	(dB)	(dB)	(dB)	(dB)	(dB)	(dB)	dB(A)	dB(A)
1	500760.53	5441418.41	2.60	0	63	68.1	68.1	0.0	0.0	78.6	0.3	-5.7	0.0	0.0	0.0	0.0	-0.0	-5.1	-5.1
2	500760.53	5441418.41	2.60	0	125	78.9	78.9	0.0	0.0	78.6	1.0	4.2	0.0	0.0	0.0	0.0	-0.0	-4.9	-4.9
3	500760.53	5441418.41	2.60	0	250	85.5	85.5	0.0	0.0	78.6	2.5	2.5	0.0	0.0	0.0	0.0	-0.0	1.8	1.8
4	500760.53	5441418.41	2.60	0	500	87.3	87.3	0.0	0.0	78.6	4.6	-1.3	0.0	0.0	0.0	0.0	-0.0	5.3	5.3
5	500760.53	5441418.41	2.60	0	1000	83.7	83.7	0.0	0.0	78.6	8.8	-1.7	0.0	0.0	0.0	0.0	-0.0	-2.0	-2.0
6	500760.53	5441418.41	2.60	0	2000	79.1	79.1	0.0	0.0	78.6	23.2	-1.7	0.0	0.0	0.0	0.0	-0.0	-21.0	-21.0
7	500760.53	5441418.41	2.60	0	4000	70.0	70.0	0.0	0.0	78.6	78.8	-1.7	0.0	0.0	0.0	0.0	-0.0	-85.7	-85.7
8	500760.53	5441418.41	2.60	0	8000	77.7	77.7	0.0	0.0	78.6	281.0	-1.7	0.0	0.0	0.0	0.0	-0.0	-280.2	-280.2

Point Source, ISO 9613, Name: "Em_Inv2", ID: "Em_Inv2"																			
Nr.	X	Y	Z	Refl.	Freq.	LxT	LxN	K0	Dc	Adiv	Aatm	Agr	Afol	Ahous	Abar	Cmet	RL	LrT	LrN
	(m)	(m)	(m)		(Hz)	dB(A)	dB(A)	(dB)	(dB)	(dB)	(dB)	(dB)	(dB)	(dB)	(dB)	(dB)	(dB)	dB(A)	dB(A)
1	500552.40	5441520.21	2.60	0	63	68.1	68.1	0.0	0.0	78.6	0.3	-5.7	0.0	0.0	0.0	0.0	-0.0	-5.1	-5.1
2	500552.40	5441520.21	2.60	0	125	78.9	78.9	0.0	0.0	78.6	1.0	4.2	0.0	0.0	0.0	0.0	-0.0	-4.9	-4.9
3	500552.40	5441520.21	2.60	0	250	85.5	85.5	0.0	0.0	78.6	2.5	2.5	0.0	0.0	0.0	0.0	-0.0	1.8	1.8
4	500552.40	5441520.21	2.60	0	500	87.3	87.3	0.0	0.0	78.6	4.6	-1.3	0.0	0.0	0.0	0.0	-0.0	5.3	5.3
5	500552.40	5441520.21	2.60	0	1000	83.7	83.7	0.0	0.0	78.6	8.8	-1.7	0.0	0.0	0.0	0.0	-0.0	-2.1	-2.1
6	500552.40	5441520.21	2.60	0	2000	79.1	79.1	0.0	0.0	78.6	23.3	-1.7	0.0	0.0	0.0	0.0	-0.0	-21.2	-21.2
7	500552.40	5441520.21	2.60	0	4000	70.0	70.0	0.0	0.0	78.6	79.1	-1.7	0.0	0.0	0.0	0.0	-0.0	-86.0	-86.0
8	500552.40	5441520.21	2.60	0	8000	77.7	77.7	0.0	0.0	78.6	282.0	-1.7	0.0	0.0	0.0	0.0	-0.0	-281.3	-281.3

Point Source, ISO 9613, Name: "Em_Inv3", ID: "Em_Inv3"																			
Nr.	X	Y	Z	Refl.	Freq.	LxT	LxN	K0	Dc	Adiv	Aatm	Agr	Afol	Ahous	Abar	Cmet	RL	LrT	LrN
	(m)	(m)	(m)		(Hz)	dB(A)	dB(A)	(dB)	(dB)	(dB)	(dB)	(dB)	(dB)	(dB)	(dB)	(dB)	(dB)	dB(A)	dB(A)
1	500760.53	5441687.21	2.60	0	63	68.1	68.1	0.0	0.0	77.7	0.3	-5.7	0.0	0.0	0.0	0.0	-0.0	-4.2	-4.2
2	500760.53	5441687.21	2.60	0	125	78.9	78.9	0.0	0.0	77.7	0.9	4.2	0.0	0.0	0.0	0.0	-0.0	-3.9	-3.9
3	500760.53	5441687.21	2.60	0	250	85.5	85.5	0.0	0.0	77.7	2.3	2.5	0.0	0.0	0.0	0.0	-0.0	3.0	3.0
4	500760.53	5441687.21	2.60	0	500	87.3	87.3	0.0	0.0	77.7	4.2	-1.3	0.0	0.0	0.0	0.0	-0.0	6.7	6.7
5	500760.53	5441687.21	2.60	0	1000	83.7	83.7	0.0	0.0	77.7	7.9	-1.7	0.0	0.0	0.0	0.0	-0.0	-0.2	-0.2
6	500760.53	5441687.21	2.60	0	2000	79.1	79.1	0.0	0.0	77.7	20.9	-1.7	0.0	0.0	0.0	0.0	-0.0	-17.8	-17.8
7	500760.53	5441687.21	2.60	0	4000	70.0	70.0	0.0	0.0	77.7	70.9	-1.7	0.0	0.0	0.0	0.0	-0.0	-76.9	-76.9
8	500760.53	5441687.21	2.60	0	8000	77.7	77.7	0.0	0.0	77.7	253.0	-1.7	0.0	0.0	0.0	0.0	-0.0	-251.3	-251.3

Point Source, ISO 9613, Name: "Em_Inv4", ID: "Em_Inv4"																			
Nr.	X	Y	Z	Refl.	Freq.	LxT	LxN	K0	Dc	Adiv	Aatm	Agr	Afol	Ahous	Abar	Cmet	RL	LrT	LrN
	(m)	(m)	(m)		(Hz)	dB(A)	dB(A)	(dB)	(dB)	(dB)	(dB)	(dB)	(dB)	(dB)	(dB)	(dB)	(dB)	dB(A)	dB(A)
1	500516.20	5441733.01	2.60	0	63	68.1	68.1	0.0	0.0	78.1	0.3	-5.7	0.0	0.0	0.0	0.0	-0.0	-4.5	-4.5
2	500516.20	5441733.01	2.60	0	125	78.9	78.9	0.0	0.0	78.1	0.9	4.2	0.0	0.0	0.0	0.0	-0.0	-4.3	-4.3
3	500516.20	5441733.01	2.60	0	250	85.5	85.5	0.0	0.0	78.1	2.3	2.5	0.0	0.0	0.0	0.0	-0.0	2.6	2.6
4	500516.20	5441733.01	2.60	0	500	87.3	87.3	0.0	0.0	78.1	4.3	-1.3	0.0	0.0	0.0	0.0	-0.0	6.2	6.2
5	500516.20	5441733.01	2.60	0	1000	83.7	83.7	0.0	0.0	78.1	8.2	-1.7	0.0	0.0	0.0	0.0	-0.0	-0.9	-0.9

Point Source, ISO 9613, Name: "Em_Inv4", ID: "Em_Inv4"																			
Nr.	X	Y	Z	Refl.	Freq.	LxT	LxN	K0	Dc	Adiv	Aatm	Agr	Afol	Ahous	Abar	Cmet	RL	LrT	LrN
	(m)	(m)	(m)		(Hz)	dB(A)	dB(A)	(dB)	(dB)	(dB)	(dB)	(dB)	(dB)	(dB)	(dB)	(dB)	(dB)	dB(A)	dB(A)
6	500516.20	5441733.01	2.60	0	2000	79.1	79.1	0.0	0.0	78.1	21.8	-1.7	0.0	0.0	0.0	0.0	-0.0	-19.0	-19.0
7	500516.20	5441733.01	2.60	0	4000	70.0	70.0	0.0	0.0	78.1	73.8	-1.7	0.0	0.0	0.0	0.0	-0.0	-80.2	-80.2
8	500516.20	5441733.01	2.60	0	8000	77.7	77.7	0.0	0.0	78.1	263.4	-1.7	0.0	0.0	0.0	0.0	-0.0	-262.0	-262.0

Point Source, ISO 9613, Name: "Em_Inv5", ID: "Em_Inv5"																			
Nr.	X	Y	Z	Refl.	Freq.	LxT	LxN	K0	Dc	Adiv	Aatm	Agr	Afol	Ahous	Abar	Cmet	RL	LrT	LrN
	(m)	(m)	(m)		(Hz)	dB(A)	dB(A)	(dB)	(dB)	(dB)	(dB)	(dB)	(dB)	(dB)	(dB)	(dB)	(dB)	dB(A)	dB(A)
1	500760.53	5441956.01	2.60	0	63	68.1	68.1	0.0	0.0	76.7	0.2	-5.7	0.0	0.0	0.0	0.0	-0.0	-3.2	-3.2
2	500760.53	5441956.01	2.60	0	125	78.9	78.9	0.0	0.0	76.7	0.8	4.2	0.0	0.0	0.0	0.0	-0.0	-2.8	-2.8
3	500760.53	5441956.01	2.60	0	250	85.5	85.5	0.0	0.0	76.7	2.0	2.5	0.0	0.0	0.0	0.0	-0.0	4.2	4.2
4	500760.53	5441956.01	2.60	0	500	87.3	87.3	0.0	0.0	76.7	3.7	-1.3	0.0	0.0	0.0	0.0	-0.0	8.1	8.1
5	500760.53	5441956.01	2.60	0	1000	83.7	83.7	0.0	0.0	76.7	7.1	-1.7	0.0	0.0	0.0	0.0	-0.0	1.6	1.6
6	500760.53	5441956.01	2.60	0	2000	79.1	79.1	0.0	0.0	76.7	18.7	-1.7	0.0	0.0	0.0	0.0	-0.0	-14.6	-14.6
7	500760.53	5441956.01	2.60	0	4000	70.0	70.0	0.0	0.0	76.7	63.3	-1.7	0.0	0.0	0.0	0.0	-0.0	-68.4	-68.4
8	500760.53	5441956.01	2.60	0	8000	77.7	77.7	0.0	0.0	76.7	225.9	-1.7	0.0	0.0	0.0	0.0	-0.0	-223.2	-223.2

Point Source, ISO 9613, Name: "Em_Inv6", ID: "Em_Inv6"																			
Nr.	X	Y	Z	Refl.	Freq.	LxT	LxN	K0	Dc	Adiv	Aatm	Agr	Afol	Ahous	Abar	Cmet	RL	LrT	LrN
	(m)	(m)	(m)		(Hz)	dB(A)	dB(A)	(dB)	(dB)	(dB)	(dB)	(dB)	(dB)	(dB)	(dB)	(dB)	(dB)	dB(A)	dB(A)
1	500498.10	5441901.01	2.60	0	63	68.1	68.1	0.0	0.0	77.6	0.3	-5.7	0.0	0.0	0.0	0.0	-0.0	-4.0	-4.0
2	500498.10	5441901.01	2.60	0	125	78.9	78.9	0.0	0.0	77.6	0.9	4.2	0.0	0.0	0.0	0.0	-0.0	-3.7	-3.7
3	500498.10	5441901.01	2.60	0	250	85.5	85.5	0.0	0.0	77.6	2.2	2.5	0.0	0.0	0.0	0.0	-0.0	3.2	3.2
4	500498.10	5441901.01	2.60	0	500	87.3	87.3	0.0	0.0	77.6	4.1	-1.3	0.0	0.0	0.0	0.0	-0.0	6.9	6.9
5	500498.10	5441901.01	2.60	0	1000	83.7	83.7	0.0	0.0	77.6	7.8	-1.7	0.0	0.0	0.0	0.0	-0.0	0.1	0.1
6	500498.10	5441901.01	2.60	0	2000	79.1	79.1	0.0	0.0	77.6	20.6	-1.7	0.0	0.0	0.0	0.0	-0.0	-17.3	-17.3
7	500498.10	5441901.01	2.60	0	4000	70.0	70.0	0.0	0.0	77.6	69.7	-1.7	0.0	0.0	0.0	0.0	-0.0	-75.6	-75.6
8	500498.10	5441901.01	2.60	0	8000	77.7	77.7	0.0	0.0	77.6	248.7	-1.7	0.0	0.0	0.0	0.0	-0.0	-246.9	-246.9

Point Source, ISO 9613, Name: "Em_Inv7", ID: "Em_Inv7"																			
Nr.	X	Y	Z	Refl.	Freq.	LxT	LxN	K0	Dc	Adiv	Aatm	Agr	Afol	Ahous	Abar	Cmet	RL	LrT	LrN
	(m)	(m)	(m)		(Hz)	dB(A)	dB(A)	(dB)	(dB)	(dB)	(dB)	(dB)	(dB)	(dB)	(dB)	(dB)	(dB)	dB(A)	dB(A)
1	500498.10	5442057.81	2.60	0	63	68.1	68.1	0.0	0.0	77.0	0.2	-5.7	0.0	0.0	0.0	0.0	-0.0	-3.5	-3.5
2	500498.10	5442057.81	2.60	0	125	78.9	78.9	0.0	0.0	77.0	0.8	4.2	0.0	0.0	0.0	0.0	-0.0	-3.2	-3.2
3	500498.10	5442057.81	2.60	0	250	85.5	85.5	0.0	0.0	77.0	2.1	2.5	0.0	0.0	0.0	0.0	-0.0	3.8	3.8
4	500498.10	5442057.81	2.60	0	500	87.3	87.3	0.0	0.0	77.0	3.9	-1.3	0.0	0.0	0.0	0.0	-0.0	7.6	7.6
5	500498.10	5442057.81	2.60	0	1000	83.7	83.7	0.0	0.0	77.0	7.3	-1.7	0.0	0.0	0.0	0.0	-0.0	1.0	1.0
6	500498.10	5442057.81	2.60	0	2000	79.1	79.1	0.0	0.0	77.0	19.4	-1.7	0.0	0.0	0.0	0.0	-0.0	-15.6	-15.6
7	500498.10	5442057.81	2.60	0	4000	70.0	70.0	0.0	0.0	77.0	65.7	-1.7	0.0	0.0	0.0	0.0	-0.0	-71.1	-71.1
8	500498.10	5442057.81	2.60	0	8000	77.7	77.7	0.0	0.0	77.0	234.4	-1.7	0.0	0.0	0.0	0.0	-0.0	-232.1	-232.1

Point Source, ISO 9613, Name: "Em_Inv8", ID: "Em_Inv8"																			
Nr.	X	Y	Z	Refl.	Freq.	LxT	LxN	K0	Dc	Adiv	Aatm	Agr	Afol	Ahous	Abar	Cmet	RL	LrT	LrN
	(m)	(m)	(m)		(Hz)	dB(A)	dB(A)	(dB)	(dB)	(dB)	(dB)	(dB)	(dB)	(dB)	(dB)	(dB)	(dB)	dB(A)	dB(A)
1	500461.90	5442281.81	2.60	0	63	68.1	68.1	0.0	0.0	76.4	0.2	-5.7	0.0	0.0	0.0	0.0	-0.0	-2.9	-2.9
2	500461.90	5442281.81	2.60	0	125	78.9	78.9	0.0	0.0	76.4	0.8	4.2	0.0	0.0	0.0	0.0	-0.0	-2.5	-2.5
3	500461.90	5442281.81	2.60	0	250	85.5	85.5	0.0	0.0	76.4	2.0	2.5	0.0	0.0	0.0	0.0	-0.0	4.6	4.6
4	500461.90	5442281.81	2.60	0	500	87.3	87.3	0.0	0.0	76.4	3.6	-1.3	0.0	0.0	0.0	0.0	-0.0	8.5	8.5
5	500461.90	5442281.81	2.60	0	1000	83.7	83.7	0.0	0.0	76.4	6.8	-1.7	0.0	0.0	0.0	0.0	-0.0	2.1	2.1
6	500461.90	5442281.81	2.60	0	2000	79.1	79.1	0.0	0.0	76.4	18.0	-1.7	0.0	0.0	0.0	0.0	-0.0	-13.7	-13.7
7	500461.90	5442281.81	2.60	0	4000	70.0	70.0	0.0	0.0	76.4	61.1	-1.7	0.0	0.0	0.0	0.0	-0.0	-65.9	-65.9
8	500461.90	5442281.81	2.60	0	8000	77.7	77.7	0.0	0.0	76.4	218.1	-1.7	0.0	0.0	0.0	0.0	-0.0	-215.1	-215.1

Point Source, ISO 9613, Name: "Em_Inv9", ID: "Em_Inv9"																			
Nr.	X	Y	Z	Refl.	Freq.	LxT	LxN	K0	Dc	Adiv	Aatm	Agr	Afol	Ahous	Abar	Cmet	RL	LrT	LrN
	(m)	(m)	(m)		(Hz)	dB(A)	dB(A)	(dB)	(dB)	(dB)	(dB)	(dB)	(dB)	(dB)	(dB)	(dB)	(dB)	dB(A)	dB(A)
1	500651.93	5442280.81	2.60	0	63	68.1	68.1	0.0	0.0	75.8	0.2	-5.6	0.0	0.0	0.0	0.0	-0.0	-2.3	-2.3
2	500651.93	5442280.81	2.60	0	125	78.9	78.9	0.0	0.0	75.8	0.7	4.2	0.0	0.0	0.0	0.0	-0.0	-1.8	-1.8
3	500651.93	5442280.81	2.60	0	250	85.5	85.5	0.0	0.0	75.8	1.8	2.6	0.0	0.0	0.0	0.0	-0.0	5.3	5.3
4	500651.93	5442280.81	2.60	0	500	87.3	87.3	0.0	0.0	75.8	3.3	-1.3	0.0	0.0	0.0	0.0	-0.0	9.4	9.4
5	500651.93	5442280.81	2.60	0	1000	83.7	83.7	0.0	0.0	75.8	6.3	-1.7	0.0	0.0	0.0	0.0	-0.0	3.2	3.2
6	500651.93	5442280.81	2.60	0	2000	79.1	79.1	0.0	0.0	75.8	16.8	-1.7	0.0	0.0	0.0	0.0	-0.0	-11.8	-11.8
7	500651.93	5442280.81	2.60	0	4000	70.0	70.0	0.0	0.0	75.8	56.9	-1.7	0.0	0.0	0.0	0.0	-0.0	-61.0	-61.0
8	500651.93	5442280.81	2.60	0	8000	77.7	77.7	0.0	0.0	75.8	203.0	-1.7	0.0	0.0	0.0	0.0	-0.0	-199.4	-199.4

Point Source, ISO 9613, Name: "Em_Inv10", ID: "Em_Inv10"																			
Nr.	X	Y	Z	Refl.	Freq.	LxT	LxN	K0	Dc	Adiv	Aatm	Agr	Afol	Ahous	Abar	Cmet	RL	LrT	LrN
	(m)	(m)	(m)		(Hz)	dB(A)	dB(A)	(dB)	(dB)	(dB)	(dB)	(dB)	(dB)	(dB)	(dB)	(dB)	(dB)	dB(A)	dB(A)
1	499992.71	5441665.81	2.60	0	63	68.1	68.1	0.0	0.0	79.4	0.3	-5.8	0.0	0.0	0.0	0.0	-0.0	-5.9	-5.9
2	499992.71	5441665.81	2.60	0	125	78.9	78.9	0.0	0.0	79.4	1.1	4.2	0.0	0.0	0.0	0.0	-0.0	-5.8	-5.8
3	499992.71	5441665.81	2.60	0	250	85.5	85.5	0.0	0.0	79.4	2.8	2.5	0.0	0.0	0.0	0.0	-0.0	0.8	0.8
4	499992.71	5441665.81	2.60	0	500	87.3	87.3	0.0	0.0	79.4	5.1	-1.3	0.0	0.0	0.0	0.0	-0.0	4.1	4.1
5	499992.71	5441665.81	2.60	0	1000	83.7	83.7	0.0	0.0	79.4	9.6	-1.7	0.0	0.0	0.0	0.0	-0.0	-3.6	-3.6
6	499992.71	5441665.81	2.60	0	2000	79.1	79.1	0.0	0.0	79.4	25.5	-1.7	0.0	0.0	0.0	0.0	-0.0	-24.1	-24.1
7	499992.71	5441665.81	2.60	0	4000	70.0	70.0	0.0	0.0	79.4	86.3	-1.7	0.0	0.0	0.0	0.0	-0.0	-94.0	-94.0
8	499992.71	5441665.81	2.60	0	8000	77.7	77.7	0.0	0.0	79.4	307.9	-1.7	0.0	0.0	0.0	0.0	-0.0	-307.9	-307.9

Point Source, ISO 9613, Name: "Em_Inv11", ID: "Em_Inv11"																			
Nr.	X	Y	Z	Refl.	Freq.	LxT	LxN	K0	Dc	Adiv	Aatm	Agr	Afol	Ahous	Abar	Cmet	RL	LrT	LrN
	(m)	(m)	(m)		(Hz)	dB(A)	dB(A)	(dB)	(dB)	(dB)	(dB)	(dB)	(dB)	(dB)	(dB)	(dB)	(dB)	dB(A)	dB(A)
1	499992.71	5441505.71	2.60	0	63	68.1	68.1	0.0	0.0	79.8	0.3	-5.8	0.0	0.0	0.0	0.0	-0.0	-6.3	-6.3
2	499992.71	5441505.71	2.60	0	125	78.9	78.9	0.0	0.0	79.8	1.1	4.2	0.0	0.0	0.0	0.0	-0.0	-6.2	-6.2
3	499992.71	5441505.71	2.60	0	250	85.5	85.5	0.0	0.0	79.8	2.9	2.5	0.0	0.0	0.0	0.0	-0.0	0.3	0.3
4	499992.71	5441505.71	2.60	0	500	87.3	87.3	0.0	0.0	79.8	5.3	-1.3	0.0	0.0	0.0	0.0	-0.0	3.5	3.5
5	499992.71	5441505.71	2.60	0	1000	83.7	83.7	0.0	0.0	79.8	10.1	-1.7	0.0	0.0	0.0	0.0	-0.0	-4.5	-4.5
6	499992.71	5441505.71	2.60	0	2000	79.1	79.1	0.0	0.0	79.8	26.6	-1.7	0.0	0.0	0.0	0.0	-0.0	-25.6	-25.6
7	499992.71	5441505.71	2.60	0	4000	70.0	70.0	0.0	0.0	79.8	90.2	-1.7	0.0	0.0	0.0	0.0	-0.0	-98.3	-98.3
8	499992.71	5441505.71	2.60	0	8000	77.7	77.7	0.0	0.0	79.8	321.9	-1.7	0.0	0.0	0.0	0.0	-0.0	-322.2	-322.2

Point Source, ISO 9613, Name: "Em_Trans1", ID: "Em_Trans1"																			
Nr.	X	Y	Z	Refl.	Freq.	LxT	LxN	K0	Dc	Adiv	Aatm	Agr	Afol	Ahous	Abar	Cmet	RL	LrT	LrN
	(m)	(m)	(m)		(Hz)	dB(A)	dB(A)	(dB)	(dB)	(dB)	(dB)	(dB)	(dB)	(dB)	(dB)	(dB)	(dB)	dB(A)	dB(A)
1	500755.03	5441418.91	2.58	0	32	37.3	37.3	0.0	0.0	78.6	0.1	-5.7	0.0	0.0	0.0	0.0	-0.0	-35.7	-35.7
2	500755.03	5441418.91	2.58	0	63	56.5	56.5	0.0	0.0	78.6	0.3	-5.7	0.0	0.0	0.0	0.0	-0.0	-16.7	-16.7
3	500755.03	5441418.91	2.58	0	125	68.6	68.6	0.0	0.0	78.6	1.0	4.2	0.0	0.0	0.0	0.0	-0.0	-15.2	-15.2
4	500755.03	5441418.91	2.58	0	250	71.1	71.1	0.0	0.0	78.6	2.5	2.6	0.0	0.0	0.0	0.0	-0.0	-12.6	-12.6
5	500755.03	5441418.91	2.58	0	500	76.5	76.5	0.0	0.0	78.6	4.6	-1.3	0.0	0.0	0.0	0.0	-0.0	-5.5	-5.5
6	500755.03	5441418.91	2.58	0	1000	73.7	73.7	0.0	0.0	78.6	8.8	-1.7	0.0	0.0	0.0	0.0	-0.0	-12.0	-12.0
7	500755.03	5441418.91	2.58	0	2000	69.9	69.9	0.0	0.0	78.6	23.3	-1.7	0.0	0.0	0.0	0.0	-0.0	-30.3	-30.3
8	500755.03	5441418.91	2.58	0	4000	64.7	64.7	0.0	0.0	78.6	78.9	-1.7	0.0	0.0	0.0	0.0	-0.0	-91.1	-91.1
9	500755.03	5441418.91	2.58	0	8000	55.6	55.6	0.0	0.0	78.6	281.3	-1.7	0.0	0.0	0.0	0.0	-0.0	-302.6	-302.6

Point Source, ISO 9613, Name: "Em_Trans2", ID: "Em_Trans2"																			
Nr.	X	Y	Z	Refl.	Freq.	LxT	LxN	K0	Dc	Adiv	Aatm	Agr	Afol	Ahous	Abar	Cmet	RL	LrT	LrN
	(m)	(m)	(m)		(Hz)	dB(A)	dB(A)	(dB)	(dB)	(dB)	(dB)	(dB)	(dB)	(dB)	(dB)	(dB)	(dB)	dB(A)	dB(A)
1	500557.90	5441519.71	2.58	0	32	37.3	37.3	0.0	0.0	78.6	0.1	-5.7	0.0	0.0	0.0	0.0	-0.0	-35.7	-35.7
2	500557.90	5441519.71	2.58	0	63	56.5	56.5	0.0	0.0	78.6	0.3	-5.7	0.0	0.0	0.0	0.0	-0.0	-16.7	-16.7
3	500557.90	5441519.71	2.58	0	125	68.6	68.6	0.0	0.0	78.6	1.0	4.2	0.0	0.0	0.0	0.0	-0.0	-15.2	-15.2
4	500557.90	5441519.71	2.58	0	250	71.1	71.1	0.0	0.0	78.6	2.5	2.6	0.0	0.0	0.0	0.0	-0.0	-12.6	-12.6
5	500557.90	5441519.71	2.58	0	500	76.5	76.5	0.0	0.0	78.6	4.6	-1.3	0.0	0.0	0.0	0.0	-0.0	-5.5	-5.5
6	500557.90	5441519.71	2.58	0	1000	73.7	73.7	0.0	0.0	78.6	8.8	-1.7	0.0	0.0	0.0	0.0	-0.0	-12.1	-12.1
7	500557.90	5441519.71	2.58	0	2000	69.9	69.9	0.0	0.0	78.6	23.3	-1.7	0.0	0.0	0.0	0.0	-0.0	-30.3	-30.3
8	500557.90	5441519.71	2.58	0	4000	64.7	64.7	0.0	0.0	78.6	79.0	-1.7	0.0	0.0	0.0	0.0	-0.0	-91.2	-91.2
9	500557.90	5441519.71	2.58	0	8000	55.6	55.6	0.0	0.0	78.6	281.8	-1.7	0.0	0.0	0.0	0.0	-0.0	-303.1	-303.1

Point Source, ISO 9613, Name: "Em_Trans3", ID: "Em_Trans3"																			
Nr.	X	Y	Z	Refl.	Freq.	LxT	LxN	K0	Dc	Adiv	Aatm	Agr	Afol	Ahous	Abar	Cmet	RL	LrT	LrN
	(m)	(m)	(m)		(Hz)	dB(A)	dB(A)	(dB)	(dB)	(dB)	(dB)	(dB)	(dB)	(dB)	(dB)	(dB)	(dB)	dB(A)	dB(A)
1	500755.03	5441687.71	2.58	0	32	37.3	37.3	0.0	0.0	77.7	0.1	-5.7	0.0	0.0	0.0	0.0	-0.0	-34.8	-34.8
2	500755.03	5441687.71	2.58	0	63	56.5	56.5	0.0	0.0	77.7	0.3	-5.7	0.0	0.0	0.0	0.0	-0.0	-15.8	-15.8
3	500755.03	5441687.71	2.58	0	125	68.6	68.6	0.0	0.0	77.7	0.9	4.2	0.0	0.0	0.0	0.0	-0.0	-14.2	-14.2
4	500755.03	5441687.71	2.58	0	250	71.1	71.1	0.0	0.0	77.7	2.3	2.6	0.0	0.0	0.0	0.0	-0.0	-11.5	-11.5
5	500755.03	5441687.71	2.58	0	500	76.5	76.5	0.0	0.0	77.7	4.2	-1.3	0.0	0.0	0.0	0.0	-0.0	-4.1	-4.1
6	500755.03	5441687.71	2.58	0	1000	73.7	73.7	0.0	0.0	77.7	7.9	-1.7	0.0	0.0	0.0	0.0	-0.0	-10.2	-10.2
7	500755.03	5441687.71	2.58	0	2000	69.9	69.9	0.0	0.0	77.7	20.9	-1.7	0.0	0.0	0.0	0.0	-0.0	-27.1	-27.1
8	500755.03	5441687.71	2.58	0	4000	64.7	64.7	0.0	0.0	77.7	71.0	-1.7	0.0	0.0	0.0	0.0	-0.0	-82.3	-82.3
9	500755.03	5441687.71	2.58	0	8000	55.6	55.6	0.0	0.0	77.7	253.3	-1.7	0.0	0.0	0.0	0.0	-0.0	-273.7	-273.7

Point Source, ISO 9613, Name: "Em_Trans4", ID: "Em_Trans4"																			
Nr.	X	Y	Z	Refl.	Freq.	LxT	LxN	K0	Dc	Adiv	Aatm	Agr	Afol	Ahous	Abar	Cmet	RL	LrT	LrN
	(m)	(m)	(m)		(Hz)	dB(A)	dB(A)	(dB)	(dB)	(dB)	(dB)	(dB)	(dB)	(dB)	(dB)	(dB)	(dB)	dB(A)	dB(A)
1	500521.70	5441732.51	2.58	0	32	37.3	37.3	0.0	0.0	78.0	0.1	-5.7	0.0	0.0	0.0	0.0	-0.0	-35.1	-35.1
2	500521.70	5441732.51	2.58	0	63	56.5	56.5	0.0	0.0	78.0	0.3	-5.7	0.0	0.0	0.0	0.0	-0.0	-16.1	-16.1
3	500521.70	5441732.51	2.58	0	125	68.6	68.6	0.0	0.0	78.0	0.9	4.2	0.0	0.0	0.0	0.0	-0.0	-14.6	-14.6
4	500521.70	5441732.51	2.58	0	250	71.1	71.1	0.0	0.0	78.0	2.3	2.6	0.0	0.0	0.0	0.0	-0.0	-11.9	-11.9
5	500521.70	5441732.51	2.58	0	500	76.5	76.5	0.0	0.0	78.0	4.3	-1.3	0.0	0.0	0.0	0.0	-0.0	-4.6	-4.6
6	500521.70	5441732.51	2.58	0	1000	73.7	73.7	0.0	0.0	78.0	8.2	-1.7	0.0	0.0	0.0	0.0	-0.0	-10.9	-10.9
7	500521.70	5441732.51	2.58	0	2000	69.9	69.9	0.0	0.0	78.0	21.8	-1.7	0.0	0.0	0.0	0.0	-0.0	-28.2	-28.2
8	500521.70	5441732.51	2.58	0	4000	64.7	64.7	0.0	0.0	78.0	73.8	-1.7	0.0	0.0	0.0	0.0	-0.0	-85.4	-85.4
9	500521.70	5441732.51	2.58	0	8000	55.6	55.6	0.0	0.0	78.0	263.1	-1.7	0.0	0.0	0.0	0.0	-0.0	-283.8	-283.8

Point Source, ISO 9613, Name: "Em_Trans5", ID: "Em_Trans5"																			
Nr.	X	Y	Z	Refl.	Freq.	LxT	LxN	K0	Dc	Adiv	Aatm	Agr	Afol	Ahous	Abar	Cmet	RL	LrT	LrN
	(m)	(m)	(m)		(Hz)	dB(A)	dB(A)	(dB)	(dB)	(dB)	(dB)	(dB)	(dB)	(dB)	(dB)	(dB)	(dB)	dB(A)	dB(A)
1	500755.03	5441956.51	2.58	0	32	37.3	37.3	0.0	0.0	76.7	0.1	-5.7	0.0	0.0	0.0	0.0	-0.0	-33.8	-33.8
2	500755.03	5441956.51	2.58	0	63	56.5	56.5	0.0	0.0	76.7	0.2	-5.7	0.0	0.0	0.0	0.0	-0.0	-14.8	-14.8
3	500755.03	5441956.51	2.58	0	125	68.6	68.6	0.0	0.0	76.7	0.8	4.2	0.0	0.0	0.0	0.0	-0.0	-13.1	-13.1
4	500755.03	5441956.51	2.58	0	250	71.1	71.1	0.0	0.0	76.7	2.0	2.6	0.0	0.0	0.0	0.0	-0.0	-10.2	-10.2
5	500755.03	5441956.51	2.58	0	500	76.5	76.5	0.0	0.0	76.7	3.7	-1.2	0.0	0.0	0.0	0.0	-0.0	-2.7	-2.7
6	500755.03	5441956.51	2.58	0	1000	73.7	73.7	0.0	0.0	76.7	7.1	-1.7	0.0	0.0	0.0	0.0	-0.0	-8.4	-8.4
7	500755.03	5441956.51	2.58	0	2000	69.9	69.9	0.0	0.0	76.7	18.7	-1.7	0.0	0.0	0.0	0.0	-0.0	-23.8	-23.8
8	500755.03	5441956.51	2.58	0	4000	64.7	64.7	0.0	0.0	76.7	63.4	-1.7	0.0	0.0	0.0	0.0	-0.0	-73.8	-73.8
9	500755.03	5441956.51	2.58	0	8000	55.6	55.6	0.0	0.0	76.7	226.2	-1.7	0.0	0.0	0.0	0.0	-0.0	-245.6	-245.6

Point Source, ISO 9613, Name: "Em_Trans6", ID: "Em_Trans6"																			
Nr.	X	Y	Z	Refl.	Freq.	LxT	LxN	K0	Dc	Adiv	Aatm	Agr	Afol	Ahous	Abar	Cmet	RL	LrT	LrN
	(m)	(m)	(m)		(Hz)	dB(A)	dB(A)	(dB)	(dB)	(dB)	(dB)	(dB)	(dB)	(dB)	(dB)	(dB)	(dB)	dB(A)	dB(A)
1	500503.60	5441900.51	2.58	0	32	37.3	37.3	0.0	0.0	77.5	0.1	-5.7	0.0	0.0	0.0	0.0	-0.0	-34.6	-34.6
2	500503.60	5441900.51	2.58	0	63	56.5	56.5	0.0	0.0	77.5	0.3	-5.7	0.0	0.0	0.0	0.0	-0.0	-15.6	-15.6
3	500503.60	5441900.51	2.58	0	125	68.6	68.6	0.0	0.0	77.5	0.9	4.2	0.0	0.0	0.0	0.0	-0.0	-14.0	-14.0
4	500503.60	5441900.51	2.58	0	250	71.1	71.1	0.0	0.0	77.5	2.2	2.6	0.0	0.0	0.0	0.0	-0.0	-11.2	-11.2
5	500503.60	5441900.51	2.58	0	500	76.5	76.5	0.0	0.0	77.5	4.1	-1.3	0.0	0.0	0.0	0.0	-0.0	-3.9	-3.9
6	500503.60	5441900.51	2.58	0	1000	73.7	73.7	0.0	0.0	77.5	7.8	-1.7	0.0	0.0	0.0	0.0	-0.0	-9.9	-9.9
7	500503.60	5441900.51	2.58	0	2000	69.9	69.9	0.0	0.0	77.5	20.5	-1.7	0.0	0.0	0.0	0.0	-0.0	-26.5	-26.5
8	500503.60	5441900.51	2.58	0	4000	64.7	64.7	0.0	0.0	77.5	69.6	-1.7	0.0	0.0	0.0	0.0	-0.0	-80.8	-80.8
9	500503.60	5441900.51	2.58	0	8000	55.6	55.6	0.0	0.0	77.5	248.4	-1.7	0.0	0.0	0.0	0.0	-0.0	-268.6	-268.6

Point Source, ISO 9613, Name: "Em_Trans7", ID: "Em_Trans7"																			
Nr.	X	Y	Z	Refl.	Freq.	LxT	LxN	K0	Dc	Adiv	Aatm	Agr	Afol	Ahous	Abar	Cmet	RL	LrT	LrN
	(m)	(m)	(m)		(Hz)	dB(A)	dB(A)	(dB)	(dB)	(dB)	(dB)	(dB)	(dB)	(dB)	(dB)	(dB)	(dB)	dB(A)	dB(A)
1	500503.60	5442057.31	2.58	0	32	37.3	37.3	0.0	0.0	77.0	0.1	-5.7	0.0	0.0	0.0	0.0	-0.0	-34.1	-34.1
2	500503.60	5442057.31	2.58	0	63	56.5	56.5	0.0	0.0	77.0	0.2	-5.7	0.0	0.0	0.0	0.0	-0.0	-15.1	-15.1
3	500503.60	5442057.31	2.58	0	125	68.6	68.6	0.0	0.0	77.0	0.8	4.2	0.0	0.0	0.0	0.0	-0.0	-13.5	-13.5
4	500503.60	5442057.31	2.58	0	250	71.1	71.1	0.0	0.0	77.0	2.1	2.6	0.0	0.0	0.0	0.0	-0.0	-10.6	-10.6
5	500503.60	5442057.31	2.58	0	500	76.5	76.5	0.0	0.0	77.0	3.9	-1.3	0.0	0.0	0.0	0.0	-0.0	-3.1	-3.1
6	500503.60	5442057.31	2.58	0	1000	73.7	73.7	0.0	0.0	77.0	7.3	-1.7	0.0	0.0	0.0	0.0	-0.0	-9.0	-9.0
7	500503.60	5442057.31	2.58	0	2000	69.9	69.9	0.0	0.0	77.0	19.4	-1.7	0.0	0.0	0.0	0.0	-0.0	-24.8	-24.8
8	500503.60	5442057.31	2.58	0	4000	64.7	64.7	0.0	0.0	77.0	65.6	-1.7	0.0	0.0	0.0	0.0	-0.0	-76.3	-76.3
9	500503.60	5442057.31	2.58	0	8000	55.6	55.6	0.0	0.0	77.0	234.1	-1.7	0.0	0.0	0.0	0.0	-0.0	-253.8	-253.8

Point Source, ISO 9613, Name: "Em_Trans8", ID: "Em_Trans8"																			
Nr.	X	Y	Z	Refl.	Freq.	LxT	LxN	K0	Dc	Adiv	Aatm	Agr	Afol	Ahous	Abar	Cmet	RL	LrT	LrN
	(m)	(m)	(m)		(Hz)	dB(A)	dB(A)	(dB)	(dB)	(dB)	(dB)	(dB)	(dB)	(dB)	(dB)	(dB)	(dB)	dB(A)	dB(A)
1	500467.40	5442281.31	2.58	0	32	37.3	37.3	0.0	0.0	76.4	0.1	-5.7	0.0	0.0	0.0	0.0	-0.0	-33.5	-33.5
2	500467.40	5442281.31	2.58	0	63	56.5	56.5	0.0	0.0	76.4	0.2	-5.7	0.0	0.0	0.0	0.0	-0.0	-14.5	-14.5
3	500467.40	5442281.31	2.58	0	125	68.6	68.6	0.0	0.0	76.4	0.8	4.2	0.0	0.0	0.0	0.0	-0.0	-12.8	-12.8
4	500467.40	5442281.31	2.58	0	250	71.1	71.1	0.0	0.0	76.4	1.9	2.6	0.0	0.0	0.0	0.0	-0.0	-9.8	-9.8
5	500467.40	5442281.31	2.58	0	500	76.5	76.5	0.0	0.0	76.4	3.6	-1.2	0.0	0.0	0.0	0.0	-0.0	-2.3	-2.3
6	500467.40	5442281.31	2.58	0	1000	73.7	73.7	0.0	0.0	76.4	6.8	-1.7	0.0	0.0	0.0	0.0	-0.0	-7.8	-7.8
7	500467.40	5442281.31	2.58	0	2000	69.9	69.9	0.0	0.0	76.4	18.0	-1.7	0.0	0.0	0.0	0.0	-0.0	-22.8	-22.8
8	500467.40	5442281.31	2.58	0	4000	64.7	64.7	0.0	0.0	76.4	61.0	-1.7	0.0	0.0	0.0	0.0	-0.0	-71.0	-71.0
9	500467.40	5442281.31	2.58	0	8000	55.6	55.6	0.0	0.0	76.4	217.7	-1.7	0.0	0.0	0.0	0.0	-0.0	-236.8	-236.8

Point Source, ISO 9613, Name: "Em_Trans9", ID: "Em_Trans9"																			
Nr.	X	Y	Z	Refl.	Freq.	LxT	LxN	K0	Dc	Adiv	Aatm	Agr	Afol	Ahous	Abar	Cmet	RL	LrT	LrN
	(m)	(m)	(m)		(Hz)	dB(A)	dB(A)	(dB)	(dB)	(dB)	(dB)	(dB)	(dB)	(dB)	(dB)	(dB)	(dB)	dB(A)	dB(A)
1	500646.43	5442281.31	2.58	0	32	37.3	37.3	0.0	0.0	75.8	0.1	-5.6	0.0	0.0	0.0	0.0	-0.0	-32.9	-32.9
2	500646.43	5442281.31	2.58	0	63	56.5	56.5	0.0	0.0	75.8	0.2	-5.6	0.0	0.0	0.0	0.0	-0.0	-13.9	-13.9
3	500646.43	5442281.31	2.58	0	125	68.6	68.6	0.0	0.0	75.8	0.7	4.2	0.0	0.0	0.0	0.0	-0.0	-12.2	-12.2
4	500646.43	5442281.31	2.58	0	250	71.1	71.1	0.0	0.0	75.8	1.8	2.6	0.0	0.0	0.0	0.0	-0.0	-9.1	-9.1
5	500646.43	5442281.31	2.58	0	500	76.5	76.5	0.0	0.0	75.8	3.3	-1.2	0.0	0.0	0.0	0.0	-0.0	-1.4	-1.4
6	500646.43	5442281.31	2.58	0	1000	73.7	73.7	0.0	0.0	75.8	6.4	-1.7	0.0	0.0	0.0	0.0	-0.0	-6.8	-6.8
7	500646.43	5442281.31	2.58	0	2000	69.9	69.9	0.0	0.0	75.8	16.8	-1.7	0.0	0.0	0.0	0.0	-0.0	-21.0	-21.0
8	500646.43	5442281.31	2.58	0	4000	64.7	64.7	0.0	0.0	75.8	57.0	-1.7	0.0	0.0	0.0	0.0	-0.0	-66.4	-66.4
9	500646.43	5442281.31	2.58	0	8000	55.6	55.6	0.0	0.0	75.8	203.3	-1.7	0.0	0.0	0.0	0.0	-0.0	-221.8	-221.8

Point Source, ISO 9613, Name: "Em_Trans10", ID: "Em_Trans10"																			
Nr.	X	Y	Z	Refl.	Freq.	LxT	LxN	K0	Dc	Adiv	Aatm	Agr	Afol	Ahous	Abar	Cmet	RL	LrT	LrN
	(m)	(m)	(m)		(Hz)	dB(A)	dB(A)	(dB)	(dB)	(dB)	(dB)	(dB)	(dB)	(dB)	(dB)	(dB)	(dB)	dB(A)	dB(A)
1	499998.21	5441665.31	2.58	0	32	37.3	37.3	0.0	0.0	79.4	0.1	-5.8	0.0	0.0	0.0	0.0	-0.0	-36.4	-36.4
2	499998.21	5441665.31	2.58	0	63	56.5	56.5	0.0	0.0	79.4	0.3	-5.8	0.0	0.0	0.0	0.0	-0.0	-17.5	-17.5
3	499998.21	5441665.31	2.58	0	125	68.6	68.6	0.0	0.0	79.4	1.1	4.2	0.0	0.0	0.0	0.0	-0.0	-16.1	-16.1
4	499998.21	5441665.31	2.58	0	250	71.1	71.1	0.0	0.0	79.4	2.8	2.5	0.0	0.0	0.0	0.0	-0.0	-13.6	-13.6
5	499998.21	5441665.31	2.58	0	500	76.5	76.5	0.0	0.0	79.4	5.1	-1.3	0.0	0.0	0.0	0.0	-0.0	-6.7	-6.7
6	499998.21	5441665.31	2.58	0	1000	73.7	73.7	0.0	0.0	79.4	9.6	-1.7	0.0	0.0	0.0	0.0	-0.0	-13.6	-13.6
7	499998.21	5441665.31	2.58	0	2000	69.9	69.9	0.0	0.0	79.4	25.4	-1.7	0.0	0.0	0.0	0.0	-0.0	-33.2	-33.2
8	499998.21	5441665.31	2.58	0	4000	64.7	64.7	0.0	0.0	79.4	86.2	-1.7	0.0	0.0	0.0	0.0	-0.0	-99.2	-99.2
9	499998.21	5441665.31	2.58	0	8000	55.6	55.6	0.0	0.0	79.4	307.6	-1.7	0.0	0.0	0.0	0.0	-0.0	-329.6	-329.6

Point Source, ISO 9613, Name: "Em_Trans11", ID: "Em_Trans11"																			
Nr.	X	Y	Z	Refl.	Freq.	LxT	LxN	K0	Dc	Adiv	Aatm	Agr	Afol	Ahous	Abar	Cmet	RL	LrT	LrN
	(m)	(m)	(m)		(Hz)	dB(A)	dB(A)	(dB)	(dB)	(dB)	(dB)	(dB)	(dB)	(dB)	(dB)	(dB)	(dB)	dB(A)	dB(A)
1	499998.21	5441505.21	2.58	0	32	37.3	37.3	0.0	0.0	79.8	0.1	-5.8	0.0	0.0	0.0	0.0	-0.0	-36.8	-36.8
2	499998.21	5441505.21	2.58	0	63	56.5	56.5	0.0	0.0	79.8	0.3	-5.8	0.0	0.0	0.0	0.0	-0.0	-17.9	-17.9
3	499998.21	5441505.21	2.58	0	125	68.6	68.6	0.0	0.0	79.8	1.1	4.2	0.0	0.0	0.0	0.0	-0.0	-16.5	-16.5
4	499998.21	5441505.21	2.58	0	250	71.1	71.1	0.0	0.0	79.8	2.9	2.5	0.0	0.0	0.0	0.0	-0.0	-14.1	-14.1
5	499998.21	5441505.21	2.58	0	500	76.5	76.5	0.0	0.0	79.8	5.3	-1.3	0.0	0.0	0.0	0.0	-0.0	-7.3	-7.3
6	499998.21	5441505.21	2.58	0	1000	73.7	73.7	0.0	0.0	79.8	10.1	-1.7	0.0	0.0	0.0	0.0	-0.0	-14.4	-14.4
7	499998.21	5441505.21	2.58	0	2000	69.9	69.9	0.0	0.0	79.8	26.6	-1.7	0.0	0.0	0.0	0.0	-0.0	-34.7	-34.7
8	499998.21	5441505.21	2.58	0	4000	64.7	64.7	0.0	0.0	79.8	90.1	-1.7	0.0	0.0	0.0	0.0	-0.0	-103.5	-103.5
9	499998.21	5441505.21	2.58	0	8000	55.6	55.6	0.0	0.0	79.8	321.5	-1.7	0.0	0.0	0.0	0.0	-0.0	-343.9	-343.9

Point Source, ISO 9613, Name: "MM_Sub115", ID: "MM_Sub115"																			
Nr.	X	Y	Z	Refl.	Freq.	LxT	LxN	K0	Dc	Adiv	Aatm	Agr	Afol	Ahous	Abar	Cmet	RL	LrT	LrN
	(m)	(m)	(m)		(Hz)	dB(A)	dB(A)	(dB)	(dB)	(dB)	(dB)	(dB)	(dB)	(dB)	(dB)	(dB)	(dB)	dB(A)	dB(A)
1	500993.61	5443521.27	3.60	0	32	43.3	43.3	0.0	0.0	69.1	0.0	-5.1	0.0	0.0	0.0	0.0	-0.0	-20.7	-20.7
2	500993.61	5443521.27	3.60	0	63	60.5	60.5	0.0	0.0	69.1	0.1	-5.1	0.0	0.0	0.0	0.0	-0.0	-3.6	-3.6
3	500993.61	5443521.27	3.60	0	125	73.6	73.6	0.0	0.0	69.1	0.3	3.8	0.0	0.0	0.0	0.0	-0.0	0.5	0.5
4	500993.61	5443521.27	3.60	0	250	79.1	79.1	0.0	0.0	69.1	0.8	1.3	0.0	0.0	0.0	0.0	-0.0	7.9	7.9
5	500993.61	5443521.27	3.60	0	500	84.5	84.5	0.0	0.0	69.1	1.6	-1.5	0.0	0.0	0.0	0.0	-0.0	15.4	15.4
6	500993.61	5443521.27	3.60	0	1000	81.7	81.7	0.0	0.0	69.1	2.9	-1.5	0.0	0.0	0.0	0.0	-0.0	11.2	11.2
7	500993.61	5443521.27	3.60	0	2000	77.9	77.9	0.0	0.0	69.1	7.8	-1.5	0.0	0.0	0.0	0.0	-0.0	2.6	2.6
8	500993.61	5443521.27	3.60	0	4000	72.7	72.7	0.0	0.0	69.1	26.3	-1.5	0.0	0.0	0.0	0.0	-0.0	-21.1	-21.1
9	500993.61	5443521.27	3.60	0	8000	62.6	62.6	0.0	0.0	69.1	93.7	-1.5	0.0	0.0	0.0	0.0	-0.0	-98.6	-98.6

Point Source, ISO 9613, Name: "MM_Inv1", ID: "MM_Inv1"																			
Nr.	X	Y	Z	Refl.	Freq.	LxT	LxN	K0	Dc	Adiv	Aatm	Agr	Afol	Ahous	Abar	Cmet	RL	LrT	LrN
	(m)	(m)	(m)		(Hz)	dB(A)	dB(A)	(dB)	(dB)	(dB)	(dB)	(dB)	(dB)	(dB)	(dB)	(dB)	(dB)	dB(A)	dB(A)
1	501222.00	5443157.66	2.60	0	63	68.1	68.1	0.0	0.0	68.1	0.1	-5.1	0.0	0.0	0.0	0.0	-0.0	5.0	5.0
2	501222.00	5443157.66	2.60	0	125	78.9	78.9	0.0	0.0	68.1	0.3	3.7	0.0	0.0	0.0	0.0	-0.0	6.8	6.8
3	501222.00	5443157.66	2.60	0	250	85.5	85.5	0.0	0.0	68.1	0.8	2.7	0.0	0.0	0.0	0.0	-0.0	13.9	13.9
4	501222.00	5443157.66	2.60	0	500	87.3	87.3	0.0	0.0	68.1	1.4	-1.1	0.0	0.0	0.0	0.0	-0.0	18.9	18.9
5	501222.00	5443157.66	2.60	0	1000	83.7	83.7	0.0	0.0	68.1	2.6	-1.5	0.0	0.0	0.0	0.0	-0.0	14.5	14.5
6	501222.00	5443157.66	2.60	0	2000	79.1	79.1	0.0	0.0	68.1	6.9	-1.5	0.0	0.0	0.0	0.0	-0.0	5.6	5.6
7	501222.00	5443157.66	2.60	0	4000	70.0	70.0	0.0	0.0	68.1	23.4	-1.5	0.0	0.0	0.0	0.0	-0.0	-20.0	-20.0
8	501222.00	5443157.66	2.60	0	8000	77.7	77.7	0.0	0.0	68.1	83.7	-1.5	0.0	0.0	0.0	0.0	-0.0	-72.5	-72.5

Point Source, ISO 9613, Name: "MM_Inv2", ID: "MM_Inv2"																			
Nr.	X	Y	Z	Refl.	Freq.	LxT	LxN	K0	Dc	Adiv	Aatm	Agr	Afol	Ahous	Abar	Cmet	RL	LrT	LrN
	(m)	(m)	(m)		(Hz)	dB(A)	dB(A)	(dB)	(dB)	(dB)	(dB)	(dB)	(dB)	(dB)	(dB)	(dB)	(dB)	dB(A)	dB(A)
1	501240.10	5442978.46	2.60	0	63	68.1	68.1	0.0	0.0	69.3	0.1	-5.2	0.0	0.0	0.0	0.0	-0.0	3.9	3.9
2	501240.10	5442978.46	2.60	0	125	78.9	78.9	0.0	0.0	69.3	0.3	3.9	0.0	0.0	0.0	0.0	-0.0	5.3	5.3
3	501240.10	5442978.46	2.60	0	250	85.5	85.5	0.0	0.0	69.3	0.9	2.7	0.0	0.0	0.0	0.0	-0.0	12.6	12.6
4	501240.10	5442978.46	2.60	0	500	87.3	87.3	0.0	0.0	69.3	1.6	-1.1	0.0	0.0	0.0	0.0	-0.0	17.5	17.5
5	501240.10	5442978.46	2.60	0	1000	83.7	83.7	0.0	0.0	69.3	3.0	-1.6	0.0	0.0	0.0	0.0	-0.0	12.9	12.9
6	501240.10	5442978.46	2.60	0	2000	79.1	79.1	0.0	0.0	69.3	8.0	-1.6	0.0	0.0	0.0	0.0	-0.0	3.4	3.4
7	501240.10	5442978.46	2.60	0	4000	70.0	70.0	0.0	0.0	69.3	27.0	-1.6	0.0	0.0	0.0	0.0	-0.0	-24.8	-24.8
8	501240.10	5442978.46	2.60	0	8000	77.7	77.7	0.0	0.0	69.3	96.3	-1.6	0.0	0.0	0.0	0.0	-0.0	-86.4	-86.4

Point Source, ISO 9613, Name: "MM_Inv3", ID: "MM_Inv3"																			
Nr.	X	Y	Z	Refl.	Freq.	LxT	LxN	K0	Dc	Adiv	Aatm	Agr	Afol	Ahous	Abar	Cmet	RL	LrT	LrN
	(m)	(m)	(m)		(Hz)	dB(A)	dB(A)	(dB)	(dB)	(dB)	(dB)	(dB)	(dB)	(dB)	(dB)	(dB)	(dB)	dB(A)	dB(A)
1	501240.10	5442776.86	2.60	0	63	68.1	68.1	0.0	0.0	70.8	0.1	-5.3	0.0	0.0	0.0	0.0	-0.0	2.5	2.5
2	501240.10	5442776.86	2.60	0	125	78.9	78.9	0.0	0.0	70.8	0.4	4.1	0.0	0.0	0.0	0.0	-0.0	3.5	3.5
3	501240.10	5442776.86	2.60	0	250	85.5	85.5	0.0	0.0	70.8	1.0	2.6	0.0	0.0	0.0	0.0	-0.0	11.0	11.0
4	501240.10	5442776.86	2.60	0	500	87.3	87.3	0.0	0.0	70.8	1.9	-1.2	0.0	0.0	0.0	0.0	-0.0	15.7	15.7
5	501240.10	5442776.86	2.60	0	1000	83.7	83.7	0.0	0.0	70.8	3.6	-1.6	0.0	0.0	0.0	0.0	-0.0	10.9	10.9
6	501240.10	5442776.86	2.60	0	2000	79.1	79.1	0.0	0.0	70.8	9.5	-1.6	0.0	0.0	0.0	0.0	-0.0	0.4	0.4
7	501240.10	5442776.86	2.60	0	4000	70.0	70.0	0.0	0.0	70.8	32.2	-1.6	0.0	0.0	0.0	0.0	-0.0	-31.5	-31.5
8	501240.10	5442776.86	2.60	0	8000	77.7	77.7	0.0	0.0	70.8	114.9	-1.6	0.0	0.0	0.0	0.0	-0.0	-106.5	-106.5

Point Source, ISO 9613, Name: "MM_Inv4", ID: "MM_Inv4"																			
Nr.	X	Y	Z	Refl.	Freq.	LxT	LxN	K0	Dc	Adiv	Aatm	Agr	Afol	Ahous	Abar	Cmet	RL	LrT	LrN
	(m)	(m)	(m)		(Hz)	dB(A)	dB(A)	(dB)	(dB)	(dB)	(dB)	(dB)	(dB)	(dB)	(dB)	(dB)	(dB)	dB(A)	dB(A)
1	501240.10	5442575.26	2.60	0	63	68.1	68.1	0.0	0.0	72.3	0.1	-5.5	0.0	0.0	0.0	0.0	-0.0	1.2	1.2
2	501240.10	5442575.26	2.60	0	125	78.9	78.9	0.0	0.0	72.3	0.5	4.2	0.0	0.0	0.0	0.0	-0.0	2.0	2.0
3	501240.10	5442575.26	2.60	0	250	85.5	85.5	0.0	0.0	72.3	1.2	2.6	0.0	0.0	0.0	0.0	-0.0	9.4	9.4
4	501240.10	5442575.26	2.60	0	500	87.3	87.3	0.0	0.0	72.3	2.2	-1.2	0.0	0.0	0.0	0.0	-0.0	14.0	14.0
5	501240.10	5442575.26	2.60	0	1000	83.7	83.7	0.0	0.0	72.3	4.2	-1.6	0.0	0.0	0.0	0.0	-0.0	8.8	8.8
6	501240.10	5442575.26	2.60	0	2000	79.1	79.1	0.0	0.0	72.3	11.2	-1.6	0.0	0.0	0.0	0.0	-0.0	-2.7	-2.7
7	501240.10	5442575.26	2.60	0	4000	70.0	70.0	0.0	0.0	72.3	37.9	-1.6	0.0	0.0	0.0	0.0	-0.0	-38.5	-38.5
8	501240.10	5442575.26	2.60	0	8000	77.7	77.7	0.0	0.0	72.3	135.1	-1.6	0.0	0.0	0.0	0.0	-0.0	-128.0	-128.0

Point Source, ISO 9613, Name: "MM_Inv5", ID: "MM_Inv5"																			
Nr.	X	Y	Z	Refl.	Freq.	LxT	LxN	K0	Dc	Adiv	Aatm	Agr	Afol	Ahous	Abar	Cmet	RL	LrT	LrN
	(m)	(m)	(m)		(Hz)	dB(A)	dB(A)	(dB)	(dB)	(dB)	(dB)	(dB)	(dB)	(dB)	(dB)	(dB)	(dB)	dB(A)	dB(A)
1	500977.67	5442553.91	2.60	0	63	68.1	68.1	0.0	0.0	73.4	0.2	-5.5	0.0	0.0	0.0	0.0	-0.0	0.1	0.1
2	500977.67	5442553.91	2.60	0	125	78.9	78.9	0.0	0.0	73.4	0.5	4.2	0.0	0.0	0.0	0.0	-0.0	0.7	0.7
3	500977.67	5442553.91	2.60	0	250	85.5	85.5	0.0	0.0	73.4	1.4	2.6	0.0	0.0	0.0	0.0	-0.0	8.1	8.1
4	500977.67	5442553.91	2.60	0	500	87.3	87.3	0.0	0.0	73.4	2.5	-1.2	0.0	0.0	0.0	0.0	-0.0	12.6	12.6
5	500977.67	5442553.91	2.60	0	1000	83.7	83.7	0.0	0.0	73.4	4.8	-1.7	0.0	0.0	0.0	0.0	-0.0	7.1	7.1
6	500977.67	5442553.91	2.60	0	2000	79.1	79.1	0.0	0.0	73.4	12.7	-1.7	0.0	0.0	0.0	0.0	-0.0	-5.4	-5.4
7	500977.67	5442553.91	2.60	0	4000	70.0	70.0	0.0	0.0	73.4	43.2	-1.7	0.0	0.0	0.0	0.0	-0.0	-44.9	-44.9
8	500977.67	5442553.91	2.60	0	8000	77.7	77.7	0.0	0.0	73.4	154.1	-1.7	0.0	0.0	0.0	0.0	-0.0	-148.1	-148.1

Point Source, ISO 9613, Name: "MM_Inv6", ID: "MM_Inv6"																			
Nr.	X	Y	Z	Refl.	Freq.	LxT	LxN	K0	Dc	Adiv	Aatm	Agr	Afol	Ahous	Abar	Cmet	RL	LrT	LrN
	(m)	(m)	(m)		(Hz)	dB(A)	dB(A)	(dB)	(dB)	(dB)	(dB)	(dB)	(dB)	(dB)	(dB)	(dB)	(dB)	dB(A)	dB(A)
1	500977.67	5442755.51	2.60	0	63	68.1	68.1	0.0	0.0	72.3	0.1	-5.5	0.0	0.0	0.0	0.0	-0.0	1.1	1.1
2	500977.67	5442755.51	2.60	0	125	78.9	78.9	0.0	0.0	72.3	0.5	4.2	0.0	0.0	0.0	0.0	-0.0	1.9	1.9
3	500977.67	5442755.51	2.60	0	250	85.5	85.5	0.0	0.0	72.3	1.2	2.6	0.0	0.0	0.0	0.0	-0.0	9.3	9.3
4	500977.67	5442755.51	2.60	0	500	87.3	87.3	0.0	0.0	72.3	2.3	-1.2	0.0	0.0	0.0	0.0	-0.0	13.9	13.9
5	500977.67	5442755.51	2.60	0	1000	83.7	83.7	0.0	0.0	72.3	4.3	-1.6	0.0	0.0	0.0	0.0	-0.0	8.7	8.7
6	500977.67	5442755.51	2.60	0	2000	79.1	79.1	0.0	0.0	72.3	11.3	-1.6	0.0	0.0	0.0	0.0	-0.0	-2.9	-2.9
7	500977.67	5442755.51	2.60	0	4000	70.0	70.0	0.0	0.0	72.3	38.2	-1.6	0.0	0.0	0.0	0.0	-0.0	-38.9	-38.9
8	500977.67	5442755.51	2.60	0	8000	77.7	77.7	0.0	0.0	72.3	136.3	-1.6	0.0	0.0	0.0	0.0	-0.0	-129.3	-129.3

Point Source, ISO 9613, Name: "MM_Inv7", ID: "MM_Inv7"																			
Nr.	X	Y	Z	Refl.	Freq.	LxT	LxN	K0	Dc	Adiv	Aatm	Agr	Afol	Ahous	Abar	Cmet	RL	LrT	LrN
	(m)	(m)	(m)		(Hz)	dB(A)	dB(A)	(dB)	(dB)	(dB)	(dB)	(dB)	(dB)	(dB)	(dB)	(dB)	(dB)	dB(A)	dB(A)
1	500977.67	5442957.06	2.60	0	63	68.1	68.1	0.0	0.0	71.3	0.1	-5.4	0.0	0.0	0.0	0.0	-0.0	2.1	2.1
2	500977.67	5442957.06	2.60	0	125	78.9	78.9	0.0	0.0	71.3	0.4	4.1	0.0	0.0	0.0	0.0	-0.0	3.1	3.1
3	500977.67	5442957.06	2.60	0	250	85.5	85.5	0.0	0.0	71.3	1.1	2.6	0.0	0.0	0.0	0.0	-0.0	10.5	10.5

Point Source, ISO 9613, Name: "MM_Inv7", ID: "MM_Inv7"																			
Nr.	X	Y	Z	Refl.	Freq.	LxT	LxN	K0	Dc	Adiv	Aatm	Agr	Afol	Ahous	Abar	Cmet	RL	LrT	LrN
	(m)	(m)	(m)		(Hz)	dB(A)	dB(A)	(dB)	(dB)	(dB)	(dB)	(dB)	(dB)	(dB)	(dB)	(dB)	(dB)	dB(A)	dB(A)
4	500977.67	5442957.06	2.60	0	500	87.3	87.3	0.0	0.0	71.3	2.0	-1.2	0.0	0.0	0.0	0.0	-0.0	15.2	15.2
5	500977.67	5442957.06	2.60	0	1000	83.7	83.7	0.0	0.0	71.3	3.8	-1.6	0.0	0.0	0.0	0.0	-0.0	10.3	10.3
6	500977.67	5442957.06	2.60	0	2000	79.1	79.1	0.0	0.0	71.3	10.0	-1.6	0.0	0.0	0.0	0.0	-0.0	-0.5	-0.5
7	500977.67	5442957.06	2.60	0	4000	70.0	70.0	0.0	0.0	71.3	33.8	-1.6	0.0	0.0	0.0	0.0	-0.0	-33.5	-33.5
8	500977.67	5442957.06	2.60	0	8000	77.7	77.7	0.0	0.0	71.3	120.6	-1.6	0.0	0.0	0.0	0.0	-0.0	-112.5	-112.5

Point Source, ISO 9613, Name: "MM_Trans1", ID: "MM_Trans1"																			
Nr.	X	Y	Z	Refl.	Freq.	LxT	LxN	K0	Dc	Adiv	Aatm	Agr	Afol	Ahous	Abar	Cmet	RL	LrT	LrN
	(m)	(m)	(m)		(Hz)	dB(A)	dB(A)	(dB)	(dB)	(dB)	(dB)	(dB)	(dB)	(dB)	(dB)	(dB)	(dB)	dB(A)	dB(A)
1	501216.50	5443158.16	2.58	0	32	37.3	37.3	0.0	0.0	68.1	0.0	-5.1	0.0	0.0	0.0	0.0	-0.0	-25.8	-25.8
2	501216.50	5443158.16	2.58	0	63	56.5	56.5	0.0	0.0	68.1	0.1	-5.1	0.0	0.0	0.0	0.0	-0.0	-6.6	-6.6
3	501216.50	5443158.16	2.58	0	125	68.6	68.6	0.0	0.0	68.1	0.3	3.7	0.0	0.0	0.0	0.0	-0.0	-3.6	-3.6
4	501216.50	5443158.16	2.58	0	250	71.1	71.1	0.0	0.0	68.1	0.8	2.8	0.0	0.0	0.0	0.0	-0.0	-0.5	-0.5
5	501216.50	5443158.16	2.58	0	500	76.5	76.5	0.0	0.0	68.1	1.4	-1.1	0.0	0.0	0.0	0.0	-0.0	8.0	8.0
6	501216.50	5443158.16	2.58	0	1000	73.7	73.7	0.0	0.0	68.1	2.6	-1.5	0.0	0.0	0.0	0.0	-0.0	4.5	4.5
7	501216.50	5443158.16	2.58	0	2000	69.9	69.9	0.0	0.0	68.1	7.0	-1.5	0.0	0.0	0.0	0.0	-0.0	-3.7	-3.7
8	501216.50	5443158.16	2.58	0	4000	64.7	64.7	0.0	0.0	68.1	23.6	-1.5	0.0	0.0	0.0	0.0	-0.0	-25.5	-25.5
9	501216.50	5443158.16	2.58	0	8000	55.6	55.6	0.0	0.0	68.1	84.1	-1.5	0.0	0.0	0.0	0.0	-0.0	-95.1	-95.1

Point Source, ISO 9613, Name: "MM_Trans2", ID: "MM_Trans2"																			
Nr.	X	Y	Z	Refl.	Freq.	LxT	LxN	K0	Dc	Adiv	Aatm	Agr	Afol	Ahous	Abar	Cmet	RL	LrT	LrN
	(m)	(m)	(m)		(Hz)	dB(A)	dB(A)	(dB)	(dB)	(dB)	(dB)	(dB)	(dB)	(dB)	(dB)	(dB)	(dB)	dB(A)	dB(A)
1	501234.60	5442978.96	2.58	0	32	37.3	37.3	0.0	0.0	69.3	0.0	-5.2	0.0	0.0	0.0	0.0	-0.0	-26.9	-26.9
2	501234.60	5442978.96	2.58	0	63	56.5	56.5	0.0	0.0	69.3	0.1	-5.2	0.0	0.0	0.0	0.0	-0.0	-7.7	-7.7
3	501234.60	5442978.96	2.58	0	125	68.6	68.6	0.0	0.0	69.3	0.3	3.9	0.0	0.0	0.0	0.0	-0.0	-5.0	-5.0
4	501234.60	5442978.96	2.58	0	250	71.1	71.1	0.0	0.0	69.3	0.9	2.7	0.0	0.0	0.0	0.0	-0.0	-1.8	-1.8
5	501234.60	5442978.96	2.58	0	500	76.5	76.5	0.0	0.0	69.3	1.6	-1.1	0.0	0.0	0.0	0.0	-0.0	6.7	6.7
6	501234.60	5442978.96	2.58	0	1000	73.7	73.7	0.0	0.0	69.3	3.0	-1.6	0.0	0.0	0.0	0.0	-0.0	2.9	2.9
7	501234.60	5442978.96	2.58	0	2000	69.9	69.9	0.0	0.0	69.3	8.0	-1.6	0.0	0.0	0.0	0.0	-0.0	-5.9	-5.9
8	501234.60	5442978.96	2.58	0	4000	64.7	64.7	0.0	0.0	69.3	27.1	-1.6	0.0	0.0	0.0	0.0	-0.0	-30.2	-30.2
9	501234.60	5442978.96	2.58	0	8000	55.6	55.6	0.0	0.0	69.3	96.7	-1.6	0.0	0.0	0.0	0.0	-0.0	-108.9	-108.9

Point Source, ISO 9613, Name: "MM_Trans3", ID: "MM_Trans3"																			
Nr.	X	Y	Z	Refl.	Freq.	LxT	LxN	K0	Dc	Adiv	Aatm	Agr	Afol	Ahous	Abar	Cmet	RL	LrT	LrN
	(m)	(m)	(m)		(Hz)	dB(A)	dB(A)	(dB)	(dB)	(dB)	(dB)	(dB)	(dB)	(dB)	(dB)	(dB)	(dB)	dB(A)	dB(A)
1	501234.60	5442777.36	2.58	0	32	37.3	37.3	0.0	0.0	70.9	0.0	-5.3	0.0	0.0	0.0	0.0	-0.0	-28.3	-28.3
2	501234.60	5442777.36	2.58	0	63	56.5	56.5	0.0	0.0	70.9	0.1	-5.3	0.0	0.0	0.0	0.0	-0.0	-9.1	-9.1
3	501234.60	5442777.36	2.58	0	125	68.6	68.6	0.0	0.0	70.9	0.4	4.1	0.0	0.0	0.0	0.0	-0.0	-6.8	-6.8
4	501234.60	5442777.36	2.58	0	250	71.1	71.1	0.0	0.0	70.9	1.0	2.7	0.0	0.0	0.0	0.0	-0.0	-3.5	-3.5
5	501234.60	5442777.36	2.58	0	500	76.5	76.5	0.0	0.0	70.9	1.9	-1.2	0.0	0.0	0.0	0.0	-0.0	4.9	4.9
6	501234.60	5442777.36	2.58	0	1000	73.7	73.7	0.0	0.0	70.9	3.6	-1.6	0.0	0.0	0.0	0.0	-0.0	0.8	0.8
7	501234.60	5442777.36	2.58	0	2000	69.9	69.9	0.0	0.0	70.9	9.5	-1.6	0.0	0.0	0.0	0.0	-0.0	-8.9	-8.9
8	501234.60	5442777.36	2.58	0	4000	64.7	64.7	0.0	0.0	70.9	32.3	-1.6	0.0	0.0	0.0	0.0	-0.0	-36.9	-36.9
9	501234.60	5442777.36	2.58	0	8000	55.6	55.6	0.0	0.0	70.9	115.2	-1.6	0.0	0.0	0.0	0.0	-0.0	-128.9	-128.9

Point Source, ISO 9613, Name: "MM_Trans4", ID: "MM_Trans4"																			
Nr.	X	Y	Z	Refl.	Freq.	LxT	LxN	K0	Dc	Adiv	Aatm	Agr	Afol	Ahous	Abar	Cmet	RL	LrT	LrN
	(m)	(m)	(m)		(Hz)	dB(A)	dB(A)	(dB)	(dB)	(dB)	(dB)	(dB)	(dB)	(dB)	(dB)	(dB)	(dB)	dB(A)	dB(A)
1	501234.60	5442575.76	2.58	0	32	37.3	37.3	0.0	0.0	72.3	0.0	-5.5	0.0	0.0	0.0	0.0	-0.0	-29.6	-29.6
2	501234.60	5442575.76	2.58	0	63	56.5	56.5	0.0	0.0	72.3	0.1	-5.5	0.0	0.0	0.0	0.0	-0.0	-10.5	-10.5
3	501234.60	5442575.76	2.58	0	125	68.6	68.6	0.0	0.0	72.3	0.5	4.2	0.0	0.0	0.0	0.0	-0.0	-8.4	-8.4
4	501234.60	5442575.76	2.58	0	250	71.1	71.1	0.0	0.0	72.3	1.2	2.6	0.0	0.0	0.0	0.0	-0.0	-5.0	-5.0
5	501234.60	5442575.76	2.58	0	500	76.5	76.5	0.0	0.0	72.3	2.2	-1.2	0.0	0.0	0.0	0.0	-0.0	3.2	3.2
6	501234.60	5442575.76	2.58	0	1000	73.7	73.7	0.0	0.0	72.3	4.2	-1.6	0.0	0.0	0.0	0.0	-0.0	-1.2	-1.2
7	501234.60	5442575.76	2.58	0	2000	69.9	69.9	0.0	0.0	72.3	11.2	-1.6	0.0	0.0	0.0	0.0	-0.0	-11.9	-11.9
8	501234.60	5442575.76	2.58	0	4000	64.7	64.7	0.0	0.0	72.3	37.9	-1.6	0.0	0.0	0.0	0.0	-0.0	-43.9	-43.9
9	501234.60	5442575.76	2.58	0	8000	55.6	55.6	0.0	0.0	72.3	135.3	-1.6	0.0	0.0	0.0	0.0	-0.0	-150.3	-150.3

Point Source, ISO 9613, Name: "MM_Trans5", ID: "MM_Trans5"																			
Nr.	X	Y	Z	Refl.	Freq.	LxT	LxN	K0	Dc	Adiv	Aatm	Agr	Afol	Ahous	Abar	Cmet	RL	LrT	LrN
	(m)	(m)	(m)		(Hz)	dB(A)	dB(A)	(dB)	(dB)	(dB)	(dB)	(dB)	(dB)	(dB)	(dB)	(dB)	(dB)	dB(A)	dB(A)
1	500983.17	5442553.41	2.58	0	32	37.3	37.3	0.0	0.0	73.4	0.0	-5.5	0.0	0.0	0.0	0.0	-0.0	-30.6	-30.6
2	500983.17	5442553.41	2.58	0	63	56.5	56.5	0.0	0.0	73.4	0.2	-5.5	0.0	0.0	0.0	0.0	-0.0	-11.5	-11.5

Point Source, ISO 9613, Name: "MM_Trans5", ID: "MM_Trans5"																			
Nr.	X	Y	Z	Refl.	Freq.	LxT	LxN	K0	Dc	Adiv	Aatm	Agr	Afol	Ahous	Abar	Cmet	RL	LrT	LrN
	(m)	(m)	(m)		(Hz)	dB(A)	dB(A)	(dB)	(dB)	(dB)	(dB)	(dB)	(dB)	(dB)	(dB)	(dB)	(dB)	dB(A)	dB(A)
3	500983.17	5442553.41	2.58	0	125	68.6	68.6	0.0	0.0	73.4	0.5	4.2	0.0	0.0	0.0	0.0	-0.0	-9.6	-9.6
4	500983.17	5442553.41	2.58	0	250	71.1	71.1	0.0	0.0	73.4	1.4	2.6	0.0	0.0	0.0	0.0	-0.0	-6.3	-6.3
5	500983.17	5442553.41	2.58	0	500	76.5	76.5	0.0	0.0	73.4	2.5	-1.2	0.0	0.0	0.0	0.0	-0.0	1.8	1.8
6	500983.17	5442553.41	2.58	0	1000	73.7	73.7	0.0	0.0	73.4	4.8	-1.7	0.0	0.0	0.0	0.0	-0.0	-2.8	-2.8
7	500983.17	5442553.41	2.58	0	2000	69.9	69.9	0.0	0.0	73.4	12.7	-1.7	0.0	0.0	0.0	0.0	-0.0	-14.5	-14.5
8	500983.17	5442553.41	2.58	0	4000	64.7	64.7	0.0	0.0	73.4	43.1	-1.7	0.0	0.0	0.0	0.0	-0.0	-50.1	-50.1
9	500983.17	5442553.41	2.58	0	8000	55.6	55.6	0.0	0.0	73.4	153.7	-1.7	0.0	0.0	0.0	0.0	-0.0	-169.8	-169.8

Point Source, ISO 9613, Name: "MM_Trans6", ID: "MM_Trans6"																			
Nr.	X	Y	Z	Refl.	Freq.	LxT	LxN	K0	Dc	Adiv	Aatm	Agr	Afol	Ahous	Abar	Cmet	RL	LrT	LrN
	(m)	(m)	(m)		(Hz)	dB(A)	dB(A)	(dB)	(dB)	(dB)	(dB)	(dB)	(dB)	(dB)	(dB)	(dB)	(dB)	dB(A)	dB(A)
1	500983.17	5442755.01	2.58	0	32	37.3	37.3	0.0	0.0	72.3	0.0	-5.5	0.0	0.0	0.0	0.0	-0.0	-29.6	-29.6
2	500983.17	5442755.01	2.58	0	63	56.5	56.5	0.0	0.0	72.3	0.1	-5.5	0.0	0.0	0.0	0.0	-0.0	-10.5	-10.5
3	500983.17	5442755.01	2.58	0	125	68.6	68.6	0.0	0.0	72.3	0.5	4.2	0.0	0.0	0.0	0.0	-0.0	-8.4	-8.4
4	500983.17	5442755.01	2.58	0	250	71.1	71.1	0.0	0.0	72.3	1.2	2.6	0.0	0.0	0.0	0.0	-0.0	-5.1	-5.1
5	500983.17	5442755.01	2.58	0	500	76.5	76.5	0.0	0.0	72.3	2.2	-1.2	0.0	0.0	0.0	0.0	-0.0	3.1	3.1
6	500983.17	5442755.01	2.58	0	1000	73.7	73.7	0.0	0.0	72.3	4.3	-1.6	0.0	0.0	0.0	0.0	-0.0	-1.2	-1.2
7	500983.17	5442755.01	2.58	0	2000	69.9	69.9	0.0	0.0	72.3	11.2	-1.6	0.0	0.0	0.0	0.0	-0.0	-12.0	-12.0
8	500983.17	5442755.01	2.58	0	4000	64.7	64.7	0.0	0.0	72.3	38.1	-1.6	0.0	0.0	0.0	0.0	-0.0	-44.1	-44.1
9	500983.17	5442755.01	2.58	0	8000	55.6	55.6	0.0	0.0	72.3	135.9	-1.6	0.0	0.0	0.0	0.0	-0.0	-151.0	-151.0

Point Source, ISO 9613, Name: "MM_Trans7", ID: "MM_Trans7"																			
Nr.	X	Y	Z	Refl.	Freq.	LxT	LxN	K0	Dc	Adiv	Aatm	Agr	Afol	Ahous	Abar	Cmet	RL	LrT	LrN
	(m)	(m)	(m)		(Hz)	dB(A)	dB(A)	(dB)	(dB)	(dB)	(dB)	(dB)	(dB)	(dB)	(dB)	(dB)	(dB)	dB(A)	dB(A)
1	500983.17	5442956.56	2.58	0	32	37.3	37.3	0.0	0.0	71.2	0.0	-5.4	0.0	0.0	0.0	0.0	-0.0	-28.6	-28.6
2	500983.17	5442956.56	2.58	0	63	56.5	56.5	0.0	0.0	71.2	0.1	-5.4	0.0	0.0	0.0	0.0	-0.0	-9.5	-9.5
3	500983.17	5442956.56	2.58	0	125	68.6	68.6	0.0	0.0	71.2	0.4	4.1	0.0	0.0	0.0	0.0	-0.0	-7.2	-7.2
4	500983.17	5442956.56	2.58	0	250	71.1	71.1	0.0	0.0	71.2	1.1	2.7	0.0	0.0	0.0	0.0	-0.0	-3.9	-3.9
5	500983.17	5442956.56	2.58	0	500	76.5	76.5	0.0	0.0	71.2	2.0	-1.2	0.0	0.0	0.0	0.0	-0.0	4.4	4.4
6	500983.17	5442956.56	2.58	0	1000	73.7	73.7	0.0	0.0	71.2	3.8	-1.6	0.0	0.0	0.0	0.0	-0.0	0.3	0.3
7	500983.17	5442956.56	2.58	0	2000	69.9	69.9	0.0	0.0	71.2	9.9	-1.6	0.0	0.0	0.0	0.0	-0.0	-9.7	-9.7
8	500983.17	5442956.56	2.58	0	4000	64.7	64.7	0.0	0.0	71.2	33.7	-1.6	0.0	0.0	0.0	0.0	-0.0	-38.6	-38.6
9	500983.17	5442956.56	2.58	0	8000	55.6	55.6	0.0	0.0	71.2	120.1	-1.6	0.0	0.0	0.0	0.0	-0.0	-134.1	-134.1

Receiver

Name: 45_R47

ID: 45_R47

X: 502197.09

Y: 5443688.82

Z: 4.50

Point Source, ISO 9613, Name: "Ab_Sub115", ID: "Ab_Sub115"

Nr.	X (m)	Y (m)	Z (m)	Refl.	Freq. (Hz)	LxT dB(A)	LxN dB(A)	K0 (dB)	Dc (dB)	Adiv (dB)	Aatm (dB)	Agr (dB)	Afol (dB)	Ahous (dB)	Abar (dB)	Cmet (dB)	RL (dB)	LrT dB(A)	LrN dB(A)
1	501008.63	5443536.29	3.60	0	32	43.3	43.3	0.0	0.0	72.6	0.0	-5.4	0.0	0.0	0.0	0.0	-0.0	-23.9	-23.9
2	501008.63	5443536.29	3.60	0	63	60.5	60.5	0.0	0.0	72.6	0.2	-5.4	0.0	0.0	0.0	0.0	-0.0	-6.8	-6.8
3	501008.63	5443536.29	3.60	0	125	73.6	73.6	0.0	0.0	72.6	0.5	3.9	0.0	0.0	0.0	0.0	-0.0	-3.4	-3.4
4	501008.63	5443536.29	3.60	0	250	79.1	79.1	0.0	0.0	72.6	1.3	1.2	0.0	0.0	0.0	0.0	-0.0	4.0	4.0
5	501008.63	5443536.29	3.60	0	500	84.5	84.5	0.0	0.0	72.6	2.3	-1.6	0.0	0.0	0.0	0.0	-0.0	11.2	11.2
6	501008.63	5443536.29	3.60	0	1000	81.7	81.7	0.0	0.0	72.6	4.4	-1.6	0.0	0.0	0.0	0.0	-0.0	6.4	6.4
7	501008.63	5443536.29	3.60	0	2000	77.9	77.9	0.0	0.0	72.6	11.6	-1.6	0.0	0.0	0.0	0.0	-0.0	-4.6	-4.6
8	501008.63	5443536.29	3.60	0	4000	72.7	72.7	0.0	0.0	72.6	39.3	-1.6	0.0	0.0	0.0	0.0	-0.0	-37.5	-37.5
9	501008.63	5443536.29	3.60	0	8000	62.6	62.6	0.0	0.0	72.6	140.1	-1.6	0.0	0.0	0.0	0.0	-0.0	-148.4	-148.4

Point Source, ISO 9613, Name: "Ab_Inv1", ID: "Ab_Inv1"

Nr.	X (m)	Y (m)	Z (m)	Refl.	Freq. (Hz)	LxT dB(A)	LxN dB(A)	K0 (dB)	Dc (dB)	Adiv (dB)	Aatm (dB)	Agr (dB)	Afol (dB)	Ahous (dB)	Abar (dB)	Cmet (dB)	RL (dB)	LrT dB(A)	LrN dB(A)
1	501813.68	5442663.24	2.60	0	63	68.1	68.1	0.0	0.0	71.8	0.1	-5.4	0.0	0.0	0.0	0.0	-0.0	1.6	1.6
2	501813.68	5442663.24	2.60	0	125	78.9	78.9	0.0	0.0	71.8	0.5	4.2	0.0	0.0	0.0	0.0	-0.0	2.5	2.5
3	501813.68	5442663.24	2.60	0	250	85.5	85.5	0.0	0.0	71.8	1.1	2.6	0.0	0.0	0.0	0.0	-0.0	10.0	10.0
4	501813.68	5442663.24	2.60	0	500	87.3	87.3	0.0	0.0	71.8	2.1	-1.2	0.0	0.0	0.0	0.0	-0.0	14.6	14.6
5	501813.68	5442663.24	2.60	0	1000	83.7	83.7	0.0	0.0	71.8	4.0	-1.6	0.0	0.0	0.0	0.0	-0.0	9.5	9.5
6	501813.68	5442663.24	2.60	0	2000	79.1	79.1	0.0	0.0	71.8	10.6	-1.6	0.0	0.0	0.0	0.0	-0.0	-1.6	-1.6
7	501813.68	5442663.24	2.60	0	4000	70.0	70.0	0.0	0.0	71.8	35.9	-1.6	0.0	0.0	0.0	0.0	-0.0	-36.0	-36.0
8	501813.68	5442663.24	2.60	0	8000	77.7	77.7	0.0	0.0	71.8	128.0	-1.6	0.0	0.0	0.0	0.0	-0.0	-120.4	-120.4

Point Source, ISO 9613, Name: "Ab_Inv2", ID: "Ab_Inv2"

Nr.	X (m)	Y (m)	Z (m)	Refl.	Freq. (Hz)	LxT dB(A)	LxN dB(A)	K0 (dB)	Dc (dB)	Adiv (dB)	Aatm (dB)	Agr (dB)	Afol (dB)	Ahous (dB)	Abar (dB)	Cmet (dB)	RL (dB)	LrT dB(A)	LrN dB(A)
1	501813.68	5442842.44	2.60	0	63	68.1	68.1	0.0	0.0	70.4	0.1	-5.3	0.0	0.0	0.0	0.0	-0.0	2.9	2.9
2	501813.68	5442842.44	2.60	0	125	78.9	78.9	0.0	0.0	70.4	0.4	4.1	0.0	0.0	0.0	0.0	-0.0	4.1	4.1
3	501813.68	5442842.44	2.60	0	250	85.5	85.5	0.0	0.0	70.4	1.0	2.7	0.0	0.0	0.0	0.0	-0.0	11.5	11.5
4	501813.68	5442842.44	2.60	0	500	87.3	87.3	0.0	0.0	70.4	1.8	-1.2	0.0	0.0	0.0	0.0	-0.0	16.3	16.3
5	501813.68	5442842.44	2.60	0	1000	83.7	83.7	0.0	0.0	70.4	3.4	-1.6	0.0	0.0	0.0	0.0	-0.0	11.5	11.5
6	501813.68	5442842.44	2.60	0	2000	79.1	79.1	0.0	0.0	70.4	9.0	-1.6	0.0	0.0	0.0	0.0	-0.0	1.4	1.4
7	501813.68	5442842.44	2.60	0	4000	70.0	70.0	0.0	0.0	70.4	30.4	-1.6	0.0	0.0	0.0	0.0	-0.0	-29.2	-29.2
8	501813.68	5442842.44	2.60	0	8000	77.7	77.7	0.0	0.0	70.4	108.6	-1.6	0.0	0.0	0.0	0.0	-0.0	-99.7	-99.7

Point Source, ISO 9613, Name: "Ab_Inv3", ID: "Ab_Inv3"

Nr.	X (m)	Y (m)	Z (m)	Refl.	Freq. (Hz)	LxT dB(A)	LxN dB(A)	K0 (dB)	Dc (dB)	Adiv (dB)	Aatm (dB)	Agr (dB)	Afol (dB)	Ahous (dB)	Abar (dB)	Cmet (dB)	RL (dB)	LrT dB(A)	LrN dB(A)
1	501813.58	5443021.64	2.60	0	63	68.1	68.1	0.0	0.0	68.7	0.1	-5.2	0.0	0.0	0.0	0.0	-0.0	4.5	4.5
2	501813.58	5443021.64	2.60	0	125	78.9	78.9	0.0	0.0	68.7	0.3	3.8	0.0	0.0	0.0	0.0	-0.0	6.0	6.0
3	501813.58	5443021.64	2.60	0	250	85.5	85.5	0.0	0.0	68.7	0.8	2.7	0.0	0.0	0.0	0.0	-0.0	13.3	13.3
4	501813.58	5443021.64	2.60	0	500	87.3	87.3	0.0	0.0	68.7	1.5	-1.1	0.0	0.0	0.0	0.0	-0.0	18.2	18.2
5	501813.58	5443021.64	2.60	0	1000	83.7	83.7	0.0	0.0	68.7	2.8	-1.5	0.0	0.0	0.0	0.0	-0.0	13.7	13.7
6	501813.58	5443021.64	2.60	0	2000	79.1	79.1	0.0	0.0	68.7	7.4	-1.6	0.0	0.0	0.0	0.0	-0.0	4.5	4.5
7	501813.58	5443021.64	2.60	0	4000	70.0	70.0	0.0	0.0	68.7	25.2	-1.6	0.0	0.0	0.0	0.0	-0.0	-22.4	-22.4
8	501813.58	5443021.64	2.60	0	8000	77.7	77.7	0.0	0.0	68.7	90.0	-1.6	0.0	0.0	0.0	0.0	-0.0	-79.4	-79.4

Point Source, ISO 9613, Name: "Ab_Inv4", ID: "Ab_Inv4"

Nr.	X (m)	Y (m)	Z (m)	Refl.	Freq. (Hz)	LxT dB(A)	LxN dB(A)	K0 (dB)	Dc (dB)	Adiv (dB)	Aatm (dB)	Agr (dB)	Afol (dB)	Ahous (dB)	Abar (dB)	Cmet (dB)	RL (dB)	LrT dB(A)	LrN dB(A)
1	501813.68	5443200.84	2.60	0	63	68.1	68.1	0.0	0.0	66.9	0.1	-5.0	0.0	0.0	0.0	0.0	-0.0	6.1	6.1
2	501813.68	5443200.84	2.60	0	125	78.9	78.9	0.0	0.0	66.9	0.3	3.5	0.0	0.0	0.0	0.0	-0.0	8.3	8.3
3	501813.68	5443200.84	2.60	0	250	85.5	85.5	0.0	0.0	66.9	0.7	2.8	0.0	0.0	0.0	0.0	-0.0	15.2	15.2
4	501813.68	5443200.84	2.60	0	500	87.3	87.3	0.0	0.0	66.9	1.2	-1.1	0.0	0.0	0.0	0.0	-0.0	20.3	20.3

Point Source, ISO 9613, Name: "Ab_Inv4", ID: "Ab_Inv4"																			
Nr.	X	Y	Z	Refl.	Freq.	LxT	LxN	K0	Dc	Adiv	Aatm	Agr	Afol	Ahous	Abar	Cmet	RL	LrT	LrN
	(m)	(m)	(m)		(Hz)	dB(A)	dB(A)	(dB)	(dB)	(dB)	(dB)	(dB)	(dB)	(dB)	(dB)	(dB)	(dB)	dB(A)	dB(A)
5	501813.68	5443200.84	2.60	0	1000	83.7	83.7	0.0	0.0	66.9	2.3	-1.5	0.0	0.0	0.0	0.0	-0.0	16.1	16.1
6	501813.68	5443200.84	2.60	0	2000	79.1	79.1	0.0	0.0	66.9	6.0	-1.5	0.0	0.0	0.0	0.0	-0.0	7.7	7.7
7	501813.68	5443200.84	2.60	0	4000	70.0	70.0	0.0	0.0	66.9	20.3	-1.5	0.0	0.0	0.0	0.0	-0.0	-15.7	-15.7
8	501813.68	5443200.84	2.60	0	8000	77.7	77.7	0.0	0.0	66.9	72.5	-1.5	0.0	0.0	0.0	0.0	-0.0	-60.2	-60.2

Point Source, ISO 9613, Name: "Ab_Inv5", ID: "Ab_Inv5"																			
Nr.	X	Y	Z	Refl.	Freq.	LxT	LxN	K0	Dc	Adiv	Aatm	Agr	Afol	Ahous	Abar	Cmet	RL	LrT	LrN
	(m)	(m)	(m)		(Hz)	dB(A)	dB(A)	(dB)	(dB)	(dB)	(dB)	(dB)	(dB)	(dB)	(dB)	(dB)	(dB)	dB(A)	dB(A)
1	502235.01	5442875.04	2.60	0	63	68.1	68.1	0.0	0.0	69.2	0.1	-5.2	0.0	0.0	0.0	0.0	-0.0	4.0	4.0
2	502235.01	5442875.04	2.60	0	125	78.9	78.9	0.0	0.0	69.2	0.3	3.9	0.0	0.0	0.0	0.0	-0.0	5.4	5.4
3	502235.01	5442875.04	2.60	0	250	85.5	85.5	0.0	0.0	69.2	0.9	2.7	0.0	0.0	0.0	0.0	-0.0	12.8	12.8
4	502235.01	5442875.04	2.60	0	500	87.3	87.3	0.0	0.0	69.2	1.6	-1.1	0.0	0.0	0.0	0.0	-0.0	17.6	17.6
5	502235.01	5442875.04	2.60	0	1000	83.7	83.7	0.0	0.0	69.2	3.0	-1.6	0.0	0.0	0.0	0.0	-0.0	13.1	13.1
6	502235.01	5442875.04	2.60	0	2000	79.1	79.1	0.0	0.0	69.2	7.9	-1.6	0.0	0.0	0.0	0.0	-0.0	3.6	3.6
7	502235.01	5442875.04	2.60	0	4000	70.0	70.0	0.0	0.0	69.2	26.7	-1.6	0.0	0.0	0.0	0.0	-0.0	-24.4	-24.4
8	502235.01	5442875.04	2.60	0	8000	77.7	77.7	0.0	0.0	69.2	95.2	-1.6	0.0	0.0	0.0	0.0	-0.0	-85.2	-85.2

Point Source, ISO 9613, Name: "Ab_Inv6", ID: "Ab_Inv6"																			
Nr.	X	Y	Z	Refl.	Freq.	LxT	LxN	K0	Dc	Adiv	Aatm	Agr	Afol	Ahous	Abar	Cmet	RL	LrT	LrN
	(m)	(m)	(m)		(Hz)	dB(A)	dB(A)	(dB)	(dB)	(dB)	(dB)	(dB)	(dB)	(dB)	(dB)	(dB)	(dB)	dB(A)	dB(A)
1	502235.01	5443065.44	2.60	0	63	68.1	68.1	0.0	0.0	66.9	0.1	-5.0	0.0	0.0	0.0	0.0	-0.0	6.1	6.1
2	502235.01	5443065.44	2.60	0	125	78.9	78.9	0.0	0.0	66.9	0.3	3.5	0.0	0.0	0.0	0.0	-0.0	8.3	8.3
3	502235.01	5443065.44	2.60	0	250	85.5	85.5	0.0	0.0	66.9	0.7	2.8	0.0	0.0	0.0	0.0	-0.0	15.2	15.2
4	502235.01	5443065.44	2.60	0	500	87.3	87.3	0.0	0.0	66.9	1.2	-1.1	0.0	0.0	0.0	0.0	-0.0	20.2	20.2
5	502235.01	5443065.44	2.60	0	1000	83.7	83.7	0.0	0.0	66.9	2.3	-1.5	0.0	0.0	0.0	0.0	-0.0	16.0	16.0
6	502235.01	5443065.44	2.60	0	2000	79.1	79.1	0.0	0.0	66.9	6.0	-1.5	0.0	0.0	0.0	0.0	-0.0	7.6	7.6
7	502235.01	5443065.44	2.60	0	4000	70.0	70.0	0.0	0.0	66.9	20.5	-1.5	0.0	0.0	0.0	0.0	-0.0	-15.9	-15.9
8	502235.01	5443065.44	2.60	0	8000	77.7	77.7	0.0	0.0	66.9	73.0	-1.5	0.0	0.0	0.0	0.0	-0.0	-60.7	-60.7

Point Source, ISO 9613, Name: "Ab_Inv7", ID: "Ab_Inv7"																			
Nr.	X	Y	Z	Refl.	Freq.	LxT	LxN	K0	Dc	Adiv	Aatm	Agr	Afol	Ahous	Abar	Cmet	RL	LrT	LrN
	(m)	(m)	(m)		(Hz)	dB(A)	dB(A)	(dB)	(dB)	(dB)	(dB)	(dB)	(dB)	(dB)	(dB)	(dB)	(dB)	dB(A)	dB(A)
1	502235.01	5443257.84	2.60	0	63	68.1	68.1	0.0	0.0	63.7	0.1	-4.5	0.0	0.0	0.0	0.0	-0.0	8.9	8.9
2	502235.01	5443257.84	2.60	0	125	78.9	78.9	0.0	0.0	63.7	0.2	2.9	0.0	0.0	0.0	0.0	-0.0	12.1	12.1
3	502235.01	5443257.84	2.60	0	250	85.5	85.5	0.0	0.0	63.7	0.5	2.9	0.0	0.0	0.0	0.0	-0.0	18.4	18.4
4	502235.01	5443257.84	2.60	0	500	87.3	87.3	0.0	0.0	63.7	0.8	-0.9	0.0	0.0	0.0	0.0	-0.0	23.7	23.7
5	502235.01	5443257.84	2.60	0	1000	83.7	83.7	0.0	0.0	63.7	1.6	-1.4	0.0	0.0	0.0	0.0	-0.0	19.7	19.7
6	502235.01	5443257.84	2.60	0	2000	79.1	79.1	0.0	0.0	63.7	4.2	-1.4	0.0	0.0	0.0	0.0	-0.0	12.6	12.6
7	502235.01	5443257.84	2.60	0	4000	70.0	70.0	0.0	0.0	63.7	14.2	-1.4	0.0	0.0	0.0	0.0	-0.0	-6.5	-6.5
8	502235.01	5443257.84	2.60	0	8000	77.7	77.7	0.0	0.0	63.7	50.6	-1.4	0.0	0.0	0.0	0.0	-0.0	-35.2	-35.2

Point Source, ISO 9613, Name: "Ab_Trans1", ID: "Ab_Trans1"																			
Nr.	X	Y	Z	Refl.	Freq.	LxT	LxN	K0	Dc	Adiv	Aatm	Agr	Afol	Ahous	Abar	Cmet	RL	LrT	LrN
	(m)	(m)	(m)		(Hz)	dB(A)	dB(A)	(dB)	(dB)	(dB)	(dB)	(dB)	(dB)	(dB)	(dB)	(dB)	(dB)	dB(A)	dB(A)
1	501819.18	5442662.74	2.58	0	32	37.3	37.3	0.0	0.0	71.8	0.0	-5.4	0.0	0.0	0.0	0.0	-0.0	-29.1	-29.1
2	501819.18	5442662.74	2.58	0	63	56.5	56.5	0.0	0.0	71.8	0.1	-5.4	0.0	0.0	0.0	0.0	-0.0	-10.0	-10.0
3	501819.18	5442662.74	2.58	0	125	68.6	68.6	0.0	0.0	71.8	0.5	4.2	0.0	0.0	0.0	0.0	-0.0	-7.8	-7.8
4	501819.18	5442662.74	2.58	0	250	71.1	71.1	0.0	0.0	71.8	1.1	2.6	0.0	0.0	0.0	0.0	-0.0	-4.5	-4.5
5	501819.18	5442662.74	2.58	0	500	76.5	76.5	0.0	0.0	71.8	2.1	-1.2	0.0	0.0	0.0	0.0	-0.0	3.8	3.8
6	501819.18	5442662.74	2.58	0	1000	73.7	73.7	0.0	0.0	71.8	4.0	-1.6	0.0	0.0	0.0	0.0	-0.0	-0.5	-0.5
7	501819.18	5442662.74	2.58	0	2000	69.9	69.9	0.0	0.0	71.8	10.6	-1.6	0.0	0.0	0.0	0.0	-0.0	-10.8	-10.8
8	501819.18	5442662.74	2.58	0	4000	64.7	64.7	0.0	0.0	71.8	35.8	-1.6	0.0	0.0	0.0	0.0	-0.0	-41.3	-41.3
9	501819.18	5442662.74	2.58	0	8000	55.6	55.6	0.0	0.0	71.8	127.8	-1.6	0.0	0.0	0.0	0.0	-0.0	-142.4	-142.4

Point Source, ISO 9613, Name: "Ab_Trans2", ID: "Ab_Trans2"																			
Nr.	X	Y	Z	Refl.	Freq.	LxT	LxN	K0	Dc	Adiv	Aatm	Agr	Afol	Ahous	Abar	Cmet	RL	LrT	LrN
	(m)	(m)	(m)		(Hz)	dB(A)	dB(A)	(dB)	(dB)	(dB)	(dB)	(dB)	(dB)	(dB)	(dB)	(dB)	(dB)	dB(A)	dB(A)
1	501819.18	5442841.94	2.58	0	32	37.3	37.3	0.0	0.0	70.3	0.0	-5.3	0.0	0.0	0.0	0.0	-0.0	-27.8	-27.8
2	501819.18	5442841.94	2.58	0	63	56.5	56.5	0.0	0.0	70.3	0.1	-5.3	0.0	0.0	0.0	0.0	-0.0	-8.7	-8.7
3	501819.18	5442841.94	2.58	0	125	68.6	68.6	0.0	0.0	70.3	0.4	4.1	0.0	0.0	0.0	0.0	-0.0	-6.2	-6.2
4	501819.18	5442841.94	2.58	0	250	71.1	71.1	0.0	0.0	70.3	1.0	2.7	0.0	0.0	0.0	0.0	-0.0	-2.9	-2.9
5	501819.18	5442841.94	2.58	0	500	76.5	76.5	0.0	0.0	70.3	1.8	-1.1	0.0	0.0	0.0	0.0	-0.0	5.5	5.5
6	501819.18	5442841.94	2.58	0	1000	73.7	73.7	0.0	0.0	70.3	3.4	-1.6	0.0	0.0	0.0	0.0	-0.0	1.6	1.6

Point Source, ISO 9613, Name: "Ab_Trans2", ID: "Ab_Trans2"																			
Nr.	X	Y	Z	Refl.	Freq.	LxT	LxN	K0	Dc	Adiv	Aatm	Agr	Afol	Ahous	Abar	Cmet	RL	LrT	LrN
	(m)	(m)	(m)		(Hz)	dB(A)	dB(A)	(dB)	(dB)	(dB)	(dB)	(dB)	(dB)	(dB)	(dB)	(dB)	(dB)	dB(A)	dB(A)
7	501819.18	5442841.94	2.58	0	2000	69.9	69.9	0.0	0.0	70.3	9.0	-1.6	0.0	0.0	0.0	0.0	-0.0	-7.8	-7.8
8	501819.18	5442841.94	2.58	0	4000	64.7	64.7	0.0	0.0	70.3	30.4	-1.6	0.0	0.0	0.0	0.0	-0.0	-34.4	-34.4
9	501819.18	5442841.94	2.58	0	8000	55.6	55.6	0.0	0.0	70.3	108.4	-1.6	0.0	0.0	0.0	0.0	-0.0	-121.6	-121.6

Point Source, ISO 9613, Name: "Ab_Trans3", ID: "Ab_Trans3"																			
Nr.	X	Y	Z	Refl.	Freq.	LxT	LxN	K0	Dc	Adiv	Aatm	Agr	Afol	Ahous	Abar	Cmet	RL	LrT	LrN
	(m)	(m)	(m)		(Hz)	dB(A)	dB(A)	(dB)	(dB)	(dB)	(dB)	(dB)	(dB)	(dB)	(dB)	(dB)	(dB)	dB(A)	dB(A)
1	501819.08	5443021.14	2.58	0	32	37.3	37.3	0.0	0.0	68.7	0.0	-5.2	0.0	0.0	0.0	0.0	-0.0	-26.3	-26.3
2	501819.08	5443021.14	2.58	0	63	56.5	56.5	0.0	0.0	68.7	0.1	-5.2	0.0	0.0	0.0	0.0	-0.0	-7.1	-7.1
3	501819.08	5443021.14	2.58	0	125	68.6	68.6	0.0	0.0	68.7	0.3	3.8	0.0	0.0	0.0	0.0	-0.0	-4.2	-4.2
4	501819.08	5443021.14	2.58	0	250	71.1	71.1	0.0	0.0	68.7	0.8	2.7	0.0	0.0	0.0	0.0	-0.0	-1.1	-1.1
5	501819.08	5443021.14	2.58	0	500	76.5	76.5	0.0	0.0	68.7	1.5	-1.1	0.0	0.0	0.0	0.0	-0.0	7.4	7.4
6	501819.08	5443021.14	2.58	0	1000	73.7	73.7	0.0	0.0	68.7	2.8	-1.5	0.0	0.0	0.0	0.0	-0.0	3.7	3.7
7	501819.08	5443021.14	2.58	0	2000	69.9	69.9	0.0	0.0	68.7	7.4	-1.6	0.0	0.0	0.0	0.0	-0.0	-4.7	-4.7
8	501819.08	5443021.14	2.58	0	4000	64.7	64.7	0.0	0.0	68.7	25.1	-1.6	0.0	0.0	0.0	0.0	-0.0	-27.6	-27.6
9	501819.08	5443021.14	2.58	0	8000	55.6	55.6	0.0	0.0	68.7	89.7	-1.6	0.0	0.0	0.0	0.0	-0.0	-101.2	-101.2

Point Source, ISO 9613, Name: "Ab_Trans4", ID: "Ab_Trans4"																			
Nr.	X	Y	Z	Refl.	Freq.	LxT	LxN	K0	Dc	Adiv	Aatm	Agr	Afol	Ahous	Abar	Cmet	RL	LrT	LrN
	(m)	(m)	(m)		(Hz)	dB(A)	dB(A)	(dB)	(dB)	(dB)	(dB)	(dB)	(dB)	(dB)	(dB)	(dB)	(dB)	dB(A)	dB(A)
1	501819.18	5443200.34	2.58	0	32	37.3	37.3	0.0	0.0	66.8	0.0	-5.0	0.0	0.0	0.0	0.0	-0.0	-24.6	-24.6
2	501819.18	5443200.34	2.58	0	63	56.5	56.5	0.0	0.0	66.8	0.1	-5.0	0.0	0.0	0.0	0.0	-0.0	-5.4	-5.4
3	501819.18	5443200.34	2.58	0	125	68.6	68.6	0.0	0.0	66.8	0.3	3.4	0.0	0.0	0.0	0.0	-0.0	-1.9	-1.9
4	501819.18	5443200.34	2.58	0	250	71.1	71.1	0.0	0.0	66.8	0.6	2.8	0.0	0.0	0.0	0.0	-0.0	0.9	0.9
5	501819.18	5443200.34	2.58	0	500	76.5	76.5	0.0	0.0	66.8	1.2	-1.0	0.0	0.0	0.0	0.0	-0.0	9.5	9.5
6	501819.18	5443200.34	2.58	0	1000	73.7	73.7	0.0	0.0	66.8	2.3	-1.5	0.0	0.0	0.0	0.0	-0.0	6.1	6.1
7	501819.18	5443200.34	2.58	0	2000	69.9	69.9	0.0	0.0	66.8	6.0	-1.5	0.0	0.0	0.0	0.0	-0.0	-1.4	-1.4
8	501819.18	5443200.34	2.58	0	4000	64.7	64.7	0.0	0.0	66.8	20.2	-1.5	0.0	0.0	0.0	0.0	-0.0	-20.9	-20.9
9	501819.18	5443200.34	2.58	0	8000	55.6	55.6	0.0	0.0	66.8	72.2	-1.5	0.0	0.0	0.0	0.0	-0.0	-81.9	-81.9

Point Source, ISO 9613, Name: "Ab_Trans5", ID: "Ab_Trans5"																			
Nr.	X	Y	Z	Refl.	Freq.	LxT	LxN	K0	Dc	Adiv	Aatm	Agr	Afol	Ahous	Abar	Cmet	RL	LrT	LrN
	(m)	(m)	(m)		(Hz)	dB(A)	dB(A)	(dB)	(dB)	(dB)	(dB)	(dB)	(dB)	(dB)	(dB)	(dB)	(dB)	dB(A)	dB(A)
1	502229.51	5442875.54	2.58	0	32	37.3	37.3	0.0	0.0	69.2	0.0	-5.2	0.0	0.0	0.0	0.0	-0.0	-26.7	-26.7
2	502229.51	5442875.54	2.58	0	63	56.5	56.5	0.0	0.0	69.2	0.1	-5.2	0.0	0.0	0.0	0.0	-0.0	-7.6	-7.6
3	502229.51	5442875.54	2.58	0	125	68.6	68.6	0.0	0.0	69.2	0.3	3.9	0.0	0.0	0.0	0.0	-0.0	-4.8	-4.8
4	502229.51	5442875.54	2.58	0	250	71.1	71.1	0.0	0.0	69.2	0.9	2.7	0.0	0.0	0.0	0.0	-0.0	-1.7	-1.7
5	502229.51	5442875.54	2.58	0	500	76.5	76.5	0.0	0.0	69.2	1.6	-1.1	0.0	0.0	0.0	0.0	-0.0	6.8	6.8
6	502229.51	5442875.54	2.58	0	1000	73.7	73.7	0.0	0.0	69.2	3.0	-1.6	0.0	0.0	0.0	0.0	-0.0	3.1	3.1
7	502229.51	5442875.54	2.58	0	2000	69.9	69.9	0.0	0.0	69.2	7.9	-1.6	0.0	0.0	0.0	0.0	-0.0	-5.6	-5.6
8	502229.51	5442875.54	2.58	0	4000	64.7	64.7	0.0	0.0	69.2	26.7	-1.6	0.0	0.0	0.0	0.0	-0.0	-29.6	-29.6
9	502229.51	5442875.54	2.58	0	8000	55.6	55.6	0.0	0.0	69.2	95.1	-1.6	0.0	0.0	0.0	0.0	-0.0	-107.2	-107.2

Point Source, ISO 9613, Name: "Ab_Trans6", ID: "Ab_Trans6"																			
Nr.	X	Y	Z	Refl.	Freq.	LxT	LxN	K0	Dc	Adiv	Aatm	Agr	Afol	Ahous	Abar	Cmet	RL	LrT	LrN
	(m)	(m)	(m)		(Hz)	dB(A)	dB(A)	(dB)	(dB)	(dB)	(dB)	(dB)	(dB)	(dB)	(dB)	(dB)	(dB)	dB(A)	dB(A)
1	502229.51	5443065.94	2.58	0	32	37.3	37.3	0.0	0.0	66.9	0.0	-5.0	0.0	0.0	0.0	0.0	-0.0	-24.6	-24.6
2	502229.51	5443065.94	2.58	0	63	56.5	56.5	0.0	0.0	66.9	0.1	-5.0	0.0	0.0	0.0	0.0	-0.0	-5.5	-5.5
3	502229.51	5443065.94	2.58	0	125	68.6	68.6	0.0	0.0	66.9	0.3	3.5	0.0	0.0	0.0	0.0	-0.0	-2.0	-2.0
4	502229.51	5443065.94	2.58	0	250	71.1	71.1	0.0	0.0	66.9	0.7	2.8	0.0	0.0	0.0	0.0	-0.0	0.8	0.8
5	502229.51	5443065.94	2.58	0	500	76.5	76.5	0.0	0.0	66.9	1.2	-1.0	0.0	0.0	0.0	0.0	-0.0	9.4	9.4
6	502229.51	5443065.94	2.58	0	1000	73.7	73.7	0.0	0.0	66.9	2.3	-1.5	0.0	0.0	0.0	0.0	-0.0	6.0	6.0
7	502229.51	5443065.94	2.58	0	2000	69.9	69.9	0.0	0.0	66.9	6.0	-1.5	0.0	0.0	0.0	0.0	-0.0	-1.5	-1.5
8	502229.51	5443065.94	2.58	0	4000	64.7	64.7	0.0	0.0	66.9	20.4	-1.5	0.0	0.0	0.0	0.0	-0.0	-21.2	-21.2
9	502229.51	5443065.94	2.58	0	8000	55.6	55.6	0.0	0.0	66.9	72.9	-1.5	0.0	0.0	0.0	0.0	-0.0	-82.7	-82.7

Point Source, ISO 9613, Name: "Ab_Trans7", ID: "Ab_Trans7"																			
Nr.	X	Y	Z	Refl.	Freq.	LxT	LxN	K0	Dc	Adiv	Aatm	Agr	Afol	Ahous	Abar	Cmet	RL	LrT	LrN
	(m)	(m)	(m)		(Hz)	dB(A)	dB(A)	(dB)	(dB)	(dB)	(dB)	(dB)	(dB)	(dB)	(dB)	(dB)	(dB)	dB(A)	dB(A)
1	502229.51	5443258.34	2.58	0	32	37.3	37.3	0.0	0.0	63.7	0.0	-4.5	0.0	0.0	0.0	0.0	-0.0	-21.9	-21.9
2	502229.51	5443258.34	2.58	0	63	56.5	56.5	0.0	0.0	63.7	0.1	-4.5	0.0	0.0	0.0	0.0	-0.0	-2.7	-2.7
3	502229.51	5443258.34	2.58	0	125	68.6	68.6	0.0	0.0	63.7	0.2	2.9	0.0	0.0	0.0	0.0	-0.0	1.9	1.9
4	502229.51	5443258.34	2.58	0	250	71.1	71.1	0.0	0.0	63.7	0.5	2.9	0.0	0.0	0.0	0.0	-0.0	4.0	4.0

Point Source, ISO 9613, Name: "Ab_Trans7", ID: "Ab_Trans7"																			
Nr.	X	Y	Z	Refl.	Freq.	LxT	LxN	K0	Dc	Adiv	Aatm	Agr	Afol	Ahous	Abar	Cmet	RL	LrT	LrN
	(m)	(m)	(m)		(Hz)	dB(A)	dB(A)	(dB)	(dB)	(dB)	(dB)	(dB)	(dB)	(dB)	(dB)	(dB)	(dB)	dB(A)	dB(A)
5	502229.51	5443258.34	2.58	0	500	76.5	76.5	0.0	0.0	63.7	0.8	-0.9	0.0	0.0	0.0	0.0	-0.0	12.9	12.9
6	502229.51	5443258.34	2.58	0	1000	73.7	73.7	0.0	0.0	63.7	1.6	-1.4	0.0	0.0	0.0	0.0	-0.0	9.8	9.8
7	502229.51	5443258.34	2.58	0	2000	69.9	69.9	0.0	0.0	63.7	4.2	-1.4	0.0	0.0	0.0	0.0	-0.0	3.4	3.4
8	502229.51	5443258.34	2.58	0	4000	64.7	64.7	0.0	0.0	63.7	14.2	-1.4	0.0	0.0	0.0	0.0	-0.0	-11.8	-11.8
9	502229.51	5443258.34	2.58	0	8000	55.6	55.6	0.0	0.0	63.7	50.5	-1.4	0.0	0.0	0.0	0.0	-0.0	-57.2	-57.2

Point Source, ISO 9613, Name: "Em_Sub115", ID: "Em_Sub115"																			
Nr.	X	Y	Z	Refl.	Freq.	LxT	LxN	K0	Dc	Adiv	Aatm	Agr	Afol	Ahous	Abar	Cmet	RL	LrT	LrN
	(m)	(m)	(m)		(Hz)	dB(A)	dB(A)	(dB)	(dB)	(dB)	(dB)	(dB)	(dB)	(dB)	(dB)	(dB)	(dB)	dB(A)	dB(A)
1	500978.58	5443536.29	3.60	0	32	43.3	43.3	0.0	0.0	72.8	0.0	-5.4	0.0	0.0	0.0	0.0	-0.0	-24.1	-24.1
2	500978.58	5443536.29	3.60	0	63	60.5	60.5	0.0	0.0	72.8	0.2	-5.4	0.0	0.0	0.0	0.0	-0.0	-7.0	-7.0
3	500978.58	5443536.29	3.60	0	125	73.6	73.6	0.0	0.0	72.8	0.5	3.9	0.0	0.0	0.0	0.0	-0.0	-3.6	-3.6
4	500978.58	5443536.29	3.60	0	250	79.1	79.1	0.0	0.0	72.8	1.3	1.2	0.0	0.0	0.0	0.0	-0.0	3.8	3.8
5	500978.58	5443536.29	3.60	0	500	84.5	84.5	0.0	0.0	72.8	2.4	-1.6	0.0	0.0	0.0	0.0	-0.0	10.9	10.9
6	500978.58	5443536.29	3.60	0	1000	81.7	81.7	0.0	0.0	72.8	4.5	-1.6	0.0	0.0	0.0	0.0	-0.0	6.0	6.0
7	500978.58	5443536.29	3.60	0	2000	77.9	77.9	0.0	0.0	72.8	11.9	-1.6	0.0	0.0	0.0	0.0	-0.0	-5.1	-5.1
8	500978.58	5443536.29	3.60	0	4000	72.7	72.7	0.0	0.0	72.8	40.2	-1.6	0.0	0.0	0.0	0.0	-0.0	-38.7	-38.7
9	500978.58	5443536.29	3.60	0	8000	62.6	62.6	0.0	0.0	72.8	143.5	-1.6	0.0	0.0	0.0	0.0	-0.0	-152.1	-152.1

Point Source, ISO 9613, Name: "Em_Inv1", ID: "Em_Inv1"																			
Nr.	X	Y	Z	Refl.	Freq.	LxT	LxN	K0	Dc	Adiv	Aatm	Agr	Afol	Ahous	Abar	Cmet	RL	LrT	LrN
	(m)	(m)	(m)		(Hz)	dB(A)	dB(A)	(dB)	(dB)	(dB)	(dB)	(dB)	(dB)	(dB)	(dB)	(dB)	(dB)	dB(A)	dB(A)
1	500760.53	5441418.41	2.60	0	63	68.1	68.1	0.0	0.0	79.6	0.3	-5.8	0.0	0.0	0.0	0.0	-0.0	-6.0	-6.0
2	500760.53	5441418.41	2.60	0	125	78.9	78.9	0.0	0.0	79.6	1.1	4.2	0.0	0.0	0.0	0.0	-0.0	-6.0	-6.0
3	500760.53	5441418.41	2.60	0	250	85.5	85.5	0.0	0.0	79.6	2.8	2.5	0.0	0.0	0.0	0.0	-0.0	0.6	0.6
4	500760.53	5441418.41	2.60	0	500	87.3	87.3	0.0	0.0	79.6	5.2	-1.3	0.0	0.0	0.0	0.0	-0.0	3.8	3.8
5	500760.53	5441418.41	2.60	0	1000	83.7	83.7	0.0	0.0	79.6	9.8	-1.7	0.0	0.0	0.0	0.0	-0.0	-4.0	-4.0
6	500760.53	5441418.41	2.60	0	2000	79.1	79.1	0.0	0.0	79.6	26.0	-1.7	0.0	0.0	0.0	0.0	-0.0	-24.7	-24.7
7	500760.53	5441418.41	2.60	0	4000	70.0	70.0	0.0	0.0	79.6	88.0	-1.7	0.0	0.0	0.0	0.0	-0.0	-95.9	-95.9
8	500760.53	5441418.41	2.60	0	8000	77.7	77.7	0.0	0.0	79.6	314.0	-1.7	0.0	0.0	0.0	0.0	-0.0	-314.2	-314.2

Point Source, ISO 9613, Name: "Em_Inv2", ID: "Em_Inv2"																			
Nr.	X	Y	Z	Refl.	Freq.	LxT	LxN	K0	Dc	Adiv	Aatm	Agr	Afol	Ahous	Abar	Cmet	RL	LrT	LrN
	(m)	(m)	(m)		(Hz)	dB(A)	dB(A)	(dB)	(dB)	(dB)	(dB)	(dB)	(dB)	(dB)	(dB)	(dB)	(dB)	dB(A)	dB(A)
1	500552.40	5441520.21	2.60	0	63	68.1	68.1	0.0	0.0	79.7	0.3	-5.8	0.0	0.0	0.0	0.0	-0.0	-6.2	-6.2
2	500552.40	5441520.21	2.60	0	125	78.9	78.9	0.0	0.0	79.7	1.1	4.2	0.0	0.0	0.0	0.0	-0.0	-6.1	-6.1
3	500552.40	5441520.21	2.60	0	250	85.5	85.5	0.0	0.0	79.7	2.8	2.5	0.0	0.0	0.0	0.0	-0.0	0.4	0.4
4	500552.40	5441520.21	2.60	0	500	87.3	87.3	0.0	0.0	79.7	5.3	-1.3	0.0	0.0	0.0	0.0	-0.0	3.6	3.6
5	500552.40	5441520.21	2.60	0	1000	83.7	83.7	0.0	0.0	79.7	10.0	-1.7	0.0	0.0	0.0	0.0	-0.0	-4.2	-4.2
6	500552.40	5441520.21	2.60	0	2000	79.1	79.1	0.0	0.0	79.7	26.3	-1.7	0.0	0.0	0.0	0.0	-0.0	-25.2	-25.2
7	500552.40	5441520.21	2.60	0	4000	70.0	70.0	0.0	0.0	79.7	89.2	-1.7	0.0	0.0	0.0	0.0	-0.0	-97.2	-97.2
8	500552.40	5441520.21	2.60	0	8000	77.7	77.7	0.0	0.0	79.7	318.1	-1.7	0.0	0.0	0.0	0.0	-0.0	-318.4	-318.4

Point Source, ISO 9613, Name: "Em_Inv3", ID: "Em_Inv3"																			
Nr.	X	Y	Z	Refl.	Freq.	LxT	LxN	K0	Dc	Adiv	Aatm	Agr	Afol	Ahous	Abar	Cmet	RL	LrT	LrN
	(m)	(m)	(m)		(Hz)	dB(A)	dB(A)	(dB)	(dB)	(dB)	(dB)	(dB)	(dB)	(dB)	(dB)	(dB)	(dB)	dB(A)	dB(A)
1	500760.53	5441687.21	2.60	0	63	68.1	68.1	0.0	0.0	78.8	0.3	-5.7	0.0	0.0	0.0	0.0	-0.0	-5.3	-5.3
2	500760.53	5441687.21	2.60	0	125	78.9	78.9	0.0	0.0	78.8	1.0	4.2	0.0	0.0	0.0	0.0	-0.0	-5.1	-5.1
3	500760.53	5441687.21	2.60	0	250	85.5	85.5	0.0	0.0	78.8	2.6	2.5	0.0	0.0	0.0	0.0	-0.0	1.6	1.6
4	500760.53	5441687.21	2.60	0	500	87.3	87.3	0.0	0.0	78.8	4.8	-1.3	0.0	0.0	0.0	0.0	-0.0	5.0	5.0
5	500760.53	5441687.21	2.60	0	1000	83.7	83.7	0.0	0.0	78.8	9.0	-1.7	0.0	0.0	0.0	0.0	-0.0	-2.4	-2.4
6	500760.53	5441687.21	2.60	0	2000	79.1	79.1	0.0	0.0	78.8	23.8	-1.7	0.0	0.0	0.0	0.0	-0.0	-21.8	-21.8
7	500760.53	5441687.21	2.60	0	4000	70.0	70.0	0.0	0.0	78.8	80.7	-1.7	0.0	0.0	0.0	0.0	-0.0	-87.8	-87.8
8	500760.53	5441687.21	2.60	0	8000	77.7	77.7	0.0	0.0	78.8	288.0	-1.7	0.0	0.0	0.0	0.0	-0.0	-287.4	-287.4

Point Source, ISO 9613, Name: "Em_Inv4", ID: "Em_Inv4"																			
Nr.	X	Y	Z	Refl.	Freq.	LxT	LxN	K0	Dc	Adiv	Aatm	Agr	Afol	Ahous	Abar	Cmet	RL	LrT	LrN
	(m)	(m)	(m)		(Hz)	dB(A)	dB(A)	(dB)	(dB)	(dB)	(dB)	(dB)	(dB)	(dB)	(dB)	(dB)	(dB)	dB(A)	dB(A)
1	500516.20	5441733.01	2.60	0	63	68.1	68.1	0.0	0.0	79.2	0.3	-5.8	0.0	0.0	0.0	0.0	-0.0	-5.7	-5.7
2	500516.20	5441733.01	2.60	0	125	78.9	78.9	0.0	0.0	79.2	1.1	4.2	0.0	0.0	0.0	0.0	-0.0	-5.6	-5.6
3	500516.20	5441733.01	2.60	0	250	85.5	85.5	0.0	0.0	79.2	2.7	2.5	0.0	0.0	0.0	0.0	-0.0	1.1	1.1
4	500516.20	5441733.01	2.60	0	500	87.3	87.3	0.0	0.0	79.2	5.0	-1.3	0.0	0.0	0.0	0.0	-0.0	4.4	4.4
5	500516.20	5441733.01	2.60	0	1000	83.7	83.7	0.0	0.0	79.2	9.4	-1.7	0.0	0.0	0.0	0.0	-0.0	-3.2	-3.2

Point Source, ISO 9613, Name: "Em_Inv4", ID: "Em_Inv4"																			
Nr.	X	Y	Z	Refl.	Freq.	LxT	LxN	K0	Dc	Adiv	Aatm	Agr	Afol	Ahous	Abar	Cmet	RL	LrT	LrN
	(m)	(m)	(m)		(Hz)	dB(A)	dB(A)	(dB)	(dB)	(dB)	(dB)	(dB)	(dB)	(dB)	(dB)	(dB)	(dB)	dB(A)	dB(A)
6	500516.20	5441733.01	2.60	0	2000	79.1	79.1	0.0	0.0	79.2	24.9	-1.7	0.0	0.0	0.0	0.0	-0.0	-23.3	-23.3
7	500516.20	5441733.01	2.60	0	4000	70.0	70.0	0.0	0.0	79.2	84.5	-1.7	0.0	0.0	0.0	0.0	-0.0	-92.0	-92.0
8	500516.20	5441733.01	2.60	0	8000	77.7	77.7	0.0	0.0	79.2	301.4	-1.7	0.0	0.0	0.0	0.0	-0.0	-301.2	-301.2

Point Source, ISO 9613, Name: "Em_Inv5", ID: "Em_Inv5"																			
Nr.	X	Y	Z	Refl.	Freq.	LxT	LxN	K0	Dc	Adiv	Aatm	Agr	Afol	Ahous	Abar	Cmet	RL	LrT	LrN
	(m)	(m)	(m)		(Hz)	dB(A)	dB(A)	(dB)	(dB)	(dB)	(dB)	(dB)	(dB)	(dB)	(dB)	(dB)	(dB)	dB(A)	dB(A)
1	500760.53	5441956.01	2.60	0	63	68.1	68.1	0.0	0.0	78.0	0.3	-5.7	0.0	0.0	0.0	0.0	-0.0	-4.5	-4.5
2	500760.53	5441956.01	2.60	0	125	78.9	78.9	0.0	0.0	78.0	0.9	4.2	0.0	0.0	0.0	0.0	-0.0	-4.3	-4.3
3	500760.53	5441956.01	2.60	0	250	85.5	85.5	0.0	0.0	78.0	2.3	2.5	0.0	0.0	0.0	0.0	-0.0	2.6	2.6
4	500760.53	5441956.01	2.60	0	500	87.3	87.3	0.0	0.0	78.0	4.3	-1.3	0.0	0.0	0.0	0.0	-0.0	6.2	6.2
5	500760.53	5441956.01	2.60	0	1000	83.7	83.7	0.0	0.0	78.0	8.2	-1.7	0.0	0.0	0.0	0.0	-0.0	-0.9	-0.9
6	500760.53	5441956.01	2.60	0	2000	79.1	79.1	0.0	0.0	78.0	21.8	-1.7	0.0	0.0	0.0	0.0	-0.0	-19.0	-19.0
7	500760.53	5441956.01	2.60	0	4000	70.0	70.0	0.0	0.0	78.0	73.8	-1.7	0.0	0.0	0.0	0.0	-0.0	-80.1	-80.1
8	500760.53	5441956.01	2.60	0	8000	77.7	77.7	0.0	0.0	78.0	263.1	-1.7	0.0	0.0	0.0	0.0	-0.0	-261.7	-261.7

Point Source, ISO 9613, Name: "Em_Inv6", ID: "Em_Inv6"																			
Nr.	X	Y	Z	Refl.	Freq.	LxT	LxN	K0	Dc	Adiv	Aatm	Agr	Afol	Ahous	Abar	Cmet	RL	LrT	LrN
	(m)	(m)	(m)		(Hz)	dB(A)	dB(A)	(dB)	(dB)	(dB)	(dB)	(dB)	(dB)	(dB)	(dB)	(dB)	(dB)	dB(A)	dB(A)
1	500498.10	5441901.01	2.60	0	63	68.1	68.1	0.0	0.0	78.8	0.3	-5.7	0.0	0.0	0.0	0.0	-0.0	-5.3	-5.3
2	500498.10	5441901.01	2.60	0	125	78.9	78.9	0.0	0.0	78.8	1.0	4.2	0.0	0.0	0.0	0.0	-0.0	-5.1	-5.1
3	500498.10	5441901.01	2.60	0	250	85.5	85.5	0.0	0.0	78.8	2.6	2.5	0.0	0.0	0.0	0.0	-0.0	1.6	1.6
4	500498.10	5441901.01	2.60	0	500	87.3	87.3	0.0	0.0	78.8	4.8	-1.3	0.0	0.0	0.0	0.0	-0.0	5.0	5.0
5	500498.10	5441901.01	2.60	0	1000	83.7	83.7	0.0	0.0	78.8	9.0	-1.7	0.0	0.0	0.0	0.0	-0.0	-2.4	-2.4
6	500498.10	5441901.01	2.60	0	2000	79.1	79.1	0.0	0.0	78.8	23.8	-1.7	0.0	0.0	0.0	0.0	-0.0	-21.9	-21.9
7	500498.10	5441901.01	2.60	0	4000	70.0	70.0	0.0	0.0	78.8	80.8	-1.7	0.0	0.0	0.0	0.0	-0.0	-87.9	-87.9
8	500498.10	5441901.01	2.60	0	8000	77.7	77.7	0.0	0.0	78.8	288.3	-1.7	0.0	0.0	0.0	0.0	-0.0	-287.7	-287.7

Point Source, ISO 9613, Name: "Em_Inv7", ID: "Em_Inv7"																			
Nr.	X	Y	Z	Refl.	Freq.	LxT	LxN	K0	Dc	Adiv	Aatm	Agr	Afol	Ahous	Abar	Cmet	RL	LrT	LrN
	(m)	(m)	(m)		(Hz)	dB(A)	dB(A)	(dB)	(dB)	(dB)	(dB)	(dB)	(dB)	(dB)	(dB)	(dB)	(dB)	dB(A)	dB(A)
1	500498.10	5442057.81	2.60	0	63	68.1	68.1	0.0	0.0	78.4	0.3	-5.7	0.0	0.0	0.0	0.0	-0.0	-4.9	-4.9
2	500498.10	5442057.81	2.60	0	125	78.9	78.9	0.0	0.0	78.4	1.0	4.2	0.0	0.0	0.0	0.0	-0.0	-4.7	-4.7
3	500498.10	5442057.81	2.60	0	250	85.5	85.5	0.0	0.0	78.4	2.5	2.5	0.0	0.0	0.0	0.0	-0.0	2.1	2.1
4	500498.10	5442057.81	2.60	0	500	87.3	87.3	0.0	0.0	78.4	4.5	-1.3	0.0	0.0	0.0	0.0	-0.0	5.6	5.6
5	500498.10	5442057.81	2.60	0	1000	83.7	83.7	0.0	0.0	78.4	8.6	-1.7	0.0	0.0	0.0	0.0	-0.0	-1.6	-1.6
6	500498.10	5442057.81	2.60	0	2000	79.1	79.1	0.0	0.0	78.4	22.8	-1.7	0.0	0.0	0.0	0.0	-0.0	-20.4	-20.4
7	500498.10	5442057.81	2.60	0	4000	70.0	70.0	0.0	0.0	78.4	77.2	-1.7	0.0	0.0	0.0	0.0	-0.0	-83.9	-83.9
8	500498.10	5442057.81	2.60	0	8000	77.7	77.7	0.0	0.0	78.4	275.3	-1.7	0.0	0.0	0.0	0.0	-0.0	-274.3	-274.3

Point Source, ISO 9613, Name: "Em_Inv8", ID: "Em_Inv8"																			
Nr.	X	Y	Z	Refl.	Freq.	LxT	LxN	K0	Dc	Adiv	Aatm	Agr	Afol	Ahous	Abar	Cmet	RL	LrT	LrN
	(m)	(m)	(m)		(Hz)	dB(A)	dB(A)	(dB)	(dB)	(dB)	(dB)	(dB)	(dB)	(dB)	(dB)	(dB)	(dB)	dB(A)	dB(A)
1	500461.90	5442281.81	2.60	0	63	68.1	68.1	0.0	0.0	78.0	0.3	-5.7	0.0	0.0	0.0	0.0	-0.0	-4.4	-4.4
2	500461.90	5442281.81	2.60	0	125	78.9	78.9	0.0	0.0	78.0	0.9	4.2	0.0	0.0	0.0	0.0	-0.0	-4.2	-4.2
3	500461.90	5442281.81	2.60	0	250	85.5	85.5	0.0	0.0	78.0	2.3	2.5	0.0	0.0	0.0	0.0	-0.0	2.6	2.6
4	500461.90	5442281.81	2.60	0	500	87.3	87.3	0.0	0.0	78.0	4.3	-1.3	0.0	0.0	0.0	0.0	-0.0	6.3	6.3
5	500461.90	5442281.81	2.60	0	1000	83.7	83.7	0.0	0.0	78.0	8.2	-1.7	0.0	0.0	0.0	0.0	-0.0	-0.8	-0.8
6	500461.90	5442281.81	2.60	0	2000	79.1	79.1	0.0	0.0	78.0	21.6	-1.7	0.0	0.0	0.0	0.0	-0.0	-18.8	-18.8
7	500461.90	5442281.81	2.60	0	4000	70.0	70.0	0.0	0.0	78.0	73.2	-1.7	0.0	0.0	0.0	0.0	-0.0	-79.5	-79.5
8	500461.90	5442281.81	2.60	0	8000	77.7	77.7	0.0	0.0	78.0	261.1	-1.7	0.0	0.0	0.0	0.0	-0.0	-259.7	-259.7

Point Source, ISO 9613, Name: "Em_Inv9", ID: "Em_Inv9"																			
Nr.	X	Y	Z	Refl.	Freq.	LxT	LxN	K0	Dc	Adiv	Aatm	Agr	Afol	Ahous	Abar	Cmet	RL	LrT	LrN
	(m)	(m)	(m)		(Hz)	dB(A)	dB(A)	(dB)	(dB)	(dB)	(dB)	(dB)	(dB)	(dB)	(dB)	(dB)	(dB)	dB(A)	dB(A)
1	500651.93	5442280.81	2.60	0	63	68.1	68.1	0.0	0.0	77.4	0.3	-5.7	0.0	0.0	0.0	0.0	-0.0	-3.9	-3.9
2	500651.93	5442280.81	2.60	0	125	78.9	78.9	0.0	0.0	77.4	0.9	4.2	0.0	0.0	0.0	0.0	-0.0	-3.6	-3.6
3	500651.93	5442280.81	2.60	0	250	85.5	85.5	0.0	0.0	77.4	2.2	2.5	0.0	0.0	0.0	0.0	-0.0	3.4	3.4
4	500651.93	5442280.81	2.60	0	500	87.3	87.3	0.0	0.0	77.4	4.0	-1.3	0.0	0.0	0.0	0.0	-0.0	7.1	7.1
5	500651.93	5442280.81	2.60	0	1000	83.7	83.7	0.0	0.0	77.4	7.6	-1.7	0.0	0.0	0.0	0.0	-0.0	0.4	0.4
6	500651.93	5442280.81	2.60	0	2000	79.1	79.1	0.0	0.0	77.4	20.2	-1.7	0.0	0.0	0.0	0.0	-0.0	-16.8	-16.8
7	500651.93	5442280.81	2.60	0	4000	70.0	70.0	0.0	0.0	77.4	68.5	-1.7	0.0	0.0	0.0	0.0	-0.0	-74.2	-74.2
8	500651.93	5442280.81	2.60	0	8000	77.7	77.7	0.0	0.0	77.4	244.3	-1.7	0.0	0.0	0.0	0.0	-0.0	-242.3	-242.3

Point Source, ISO 9613, Name: "Em_Inv10", ID: "Em_Inv10"																			
Nr.	X	Y	Z	Refl.	Freq.	LxT	LxN	K0	Dc	Adiv	Aatm	Agr	Afol	Ahous	Abar	Cmet	RL	LrT	LrN
	(m)	(m)	(m)		(Hz)	dB(A)	dB(A)	(dB)	(dB)	(dB)	(dB)	(dB)	(dB)	(dB)	(dB)	(dB)	(dB)	dB(A)	dB(A)
1	499992.71	5441665.81	2.60	0	63	68.1	68.1	0.0	0.0	80.5	0.4	-5.8	0.0	0.0	0.0	0.0	-0.0	-7.0	-7.0
2	499992.71	5441665.81	2.60	0	125	78.9	78.9	0.0	0.0	80.5	1.2	4.2	0.0	0.0	0.0	0.0	-0.0	-7.0	-7.0
3	499992.71	5441665.81	2.60	0	250	85.5	85.5	0.0	0.0	80.5	3.1	2.5	0.0	0.0	0.0	0.0	-0.0	-0.7	-0.7
4	499992.71	5441665.81	2.60	0	500	87.3	87.3	0.0	0.0	80.5	5.8	-1.3	0.0	0.0	0.0	0.0	-0.0	2.3	2.3
5	499992.71	5441665.81	2.60	0	1000	83.7	83.7	0.0	0.0	80.5	10.9	-1.7	0.0	0.0	0.0	0.0	-0.0	-6.0	-6.0
6	499992.71	5441665.81	2.60	0	2000	79.1	79.1	0.0	0.0	80.5	28.9	-1.7	0.0	0.0	0.0	0.0	-0.0	-28.6	-28.6
7	499992.71	5441665.81	2.60	0	4000	70.0	70.0	0.0	0.0	80.5	98.0	-1.7	0.0	0.0	0.0	0.0	-0.0	-106.8	-106.8
8	499992.71	5441665.81	2.60	0	8000	77.7	77.7	0.0	0.0	80.5	349.7	-1.7	0.0	0.0	0.0	0.0	-0.0	-350.8	-350.8

Point Source, ISO 9613, Name: "Em_Trans1", ID: "Em_Trans1"																			
Nr.	X	Y	Z	Refl.	Freq.	LxT	LxN	K0	Dc	Adiv	Aatm	Agr	Afol	Ahous	Abar	Cmet	RL	LrT	LrN
	(m)	(m)	(m)		(Hz)	dB(A)	dB(A)	(dB)	(dB)	(dB)	(dB)	(dB)	(dB)	(dB)	(dB)	(dB)	(dB)	dB(A)	dB(A)
1	500755.03	5441418.91	2.58	0	32	37.3	37.3	0.0	0.0	79.6	0.1	-5.8	0.0	0.0	0.0	0.0	-0.0	-36.6	-36.6
2	500755.03	5441418.91	2.58	0	63	56.5	56.5	0.0	0.0	79.6	0.3	-5.8	0.0	0.0	0.0	0.0	-0.0	-17.7	-17.7
3	500755.03	5441418.91	2.58	0	125	68.6	68.6	0.0	0.0	79.6	1.1	4.2	0.0	0.0	0.0	0.0	-0.0	-16.3	-16.3
4	500755.03	5441418.91	2.58	0	250	71.1	71.1	0.0	0.0	79.6	2.8	2.5	0.0	0.0	0.0	0.0	-0.0	-13.9	-13.9
5	500755.03	5441418.91	2.58	0	500	76.5	76.5	0.0	0.0	79.6	5.2	-1.3	0.0	0.0	0.0	0.0	-0.0	-7.0	-7.0
6	500755.03	5441418.91	2.58	0	1000	73.7	73.7	0.0	0.0	79.6	9.8	-1.7	0.0	0.0	0.0	0.0	-0.0	-14.0	-14.0
7	500755.03	5441418.91	2.58	0	2000	69.9	69.9	0.0	0.0	79.6	26.0	-1.7	0.0	0.0	0.0	0.0	-0.0	-33.9	-33.9
8	500755.03	5441418.91	2.58	0	4000	64.7	64.7	0.0	0.0	79.6	88.1	-1.7	0.0	0.0	0.0	0.0	-0.0	-101.3	-101.3
9	500755.03	5441418.91	2.58	0	8000	55.6	55.6	0.0	0.0	79.6	314.3	-1.7	0.0	0.0	0.0	0.0	-0.0	-336.6	-336.6

Point Source, ISO 9613, Name: "Em_Trans2", ID: "Em_Trans2"																			
Nr.	X	Y	Z	Refl.	Freq.	LxT	LxN	K0	Dc	Adiv	Aatm	Agr	Afol	Ahous	Abar	Cmet	RL	LrT	LrN
	(m)	(m)	(m)		(Hz)	dB(A)	dB(A)	(dB)	(dB)	(dB)	(dB)	(dB)	(dB)	(dB)	(dB)	(dB)	(dB)	dB(A)	dB(A)
1	500557.90	5441519.71	2.58	0	32	37.3	37.3	0.0	0.0	79.7	0.1	-5.8	0.0	0.0	0.0	0.0	-0.0	-36.7	-36.7
2	500557.90	5441519.71	2.58	0	63	56.5	56.5	0.0	0.0	79.7	0.3	-5.8	0.0	0.0	0.0	0.0	-0.0	-17.8	-17.8
3	500557.90	5441519.71	2.58	0	125	68.6	68.6	0.0	0.0	79.7	1.1	4.2	0.0	0.0	0.0	0.0	-0.0	-16.4	-16.4
4	500557.90	5441519.71	2.58	0	250	71.1	71.1	0.0	0.0	79.7	2.8	2.5	0.0	0.0	0.0	0.0	-0.0	-14.0	-14.0
5	500557.90	5441519.71	2.58	0	500	76.5	76.5	0.0	0.0	79.7	5.2	-1.3	0.0	0.0	0.0	0.0	-0.0	-7.2	-7.2
6	500557.90	5441519.71	2.58	0	1000	73.7	73.7	0.0	0.0	79.7	9.9	-1.7	0.0	0.0	0.0	0.0	-0.0	-14.2	-14.2
7	500557.90	5441519.71	2.58	0	2000	69.9	69.9	0.0	0.0	79.7	26.3	-1.7	0.0	0.0	0.0	0.0	-0.0	-34.3	-34.3
8	500557.90	5441519.71	2.58	0	4000	64.7	64.7	0.0	0.0	79.7	89.1	-1.7	0.0	0.0	0.0	0.0	-0.0	-102.3	-102.3
9	500557.90	5441519.71	2.58	0	8000	55.6	55.6	0.0	0.0	79.7	317.8	-1.7	0.0	0.0	0.0	0.0	-0.0	-340.1	-340.1

Point Source, ISO 9613, Name: "Em_Trans3", ID: "Em_Trans3"																			
Nr.	X	Y	Z	Refl.	Freq.	LxT	LxN	K0	Dc	Adiv	Aatm	Agr	Afol	Ahous	Abar	Cmet	RL	LrT	LrN
	(m)	(m)	(m)		(Hz)	dB(A)	dB(A)	(dB)	(dB)	(dB)	(dB)	(dB)	(dB)	(dB)	(dB)	(dB)	(dB)	dB(A)	dB(A)
1	500755.03	5441687.71	2.58	0	32	37.3	37.3	0.0	0.0	78.8	0.1	-5.7	0.0	0.0	0.0	0.0	-0.0	-35.9	-35.9
2	500755.03	5441687.71	2.58	0	63	56.5	56.5	0.0	0.0	78.8	0.3	-5.7	0.0	0.0	0.0	0.0	-0.0	-16.9	-16.9
3	500755.03	5441687.71	2.58	0	125	68.6	68.6	0.0	0.0	78.8	1.0	4.2	0.0	0.0	0.0	0.0	-0.0	-15.5	-15.5
4	500755.03	5441687.71	2.58	0	250	71.1	71.1	0.0	0.0	78.8	2.6	2.6	0.0	0.0	0.0	0.0	-0.0	-12.9	-12.9
5	500755.03	5441687.71	2.58	0	500	76.5	76.5	0.0	0.0	78.8	4.8	-1.3	0.0	0.0	0.0	0.0	-0.0	-5.8	-5.8
6	500755.03	5441687.71	2.58	0	1000	73.7	73.7	0.0	0.0	78.8	9.0	-1.7	0.0	0.0	0.0	0.0	-0.0	-12.5	-12.5
7	500755.03	5441687.71	2.58	0	2000	69.9	69.9	0.0	0.0	78.8	23.8	-1.7	0.0	0.0	0.0	0.0	-0.0	-31.1	-31.1
8	500755.03	5441687.71	2.58	0	4000	64.7	64.7	0.0	0.0	78.8	80.8	-1.7	0.0	0.0	0.0	0.0	-0.0	-93.3	-93.3
9	500755.03	5441687.71	2.58	0	8000	55.6	55.6	0.0	0.0	78.8	288.3	-1.7	0.0	0.0	0.0	0.0	-0.0	-309.8	-309.8

Point Source, ISO 9613, Name: "Em_Trans4", ID: "Em_Trans4"																			
Nr.	X	Y	Z	Refl.	Freq.	LxT	LxN	K0	Dc	Adiv	Aatm	Agr	Afol	Ahous	Abar	Cmet	RL	LrT	LrN
	(m)	(m)	(m)		(Hz)	dB(A)	dB(A)	(dB)	(dB)	(dB)	(dB)	(dB)	(dB)	(dB)	(dB)	(dB)	(dB)	dB(A)	dB(A)
1	500521.70	5441732.51	2.58	0	32	37.3	37.3	0.0	0.0	79.2	0.1	-5.8	0.0	0.0	0.0	0.0	-0.0	-36.3	-36.3
2	500521.70	5441732.51	2.58	0	63	56.5	56.5	0.0	0.0	79.2	0.3	-5.8	0.0	0.0	0.0	0.0	-0.0	-17.3	-17.3
3	500521.70	5441732.51	2.58	0	125	68.6	68.6	0.0	0.0	79.2	1.1	4.2	0.0	0.0	0.0	0.0	-0.0	-15.9	-15.9
4	500521.70	5441732.51	2.58	0	250	71.1	71.1	0.0	0.0	79.2	2.7	2.5	0.0	0.0	0.0	0.0	-0.0	-13.4	-13.4
5	500521.70	5441732.51	2.58	0	500	76.5	76.5	0.0	0.0	79.2	5.0	-1.3	0.0	0.0	0.0	0.0	-0.0	-6.4	-6.4
6	500521.70	5441732.51	2.58	0	1000	73.7	73.7	0.0	0.0	79.2	9.4	-1.7	0.0	0.0	0.0	0.0	-0.0	-13.2	-13.2
7	500521.70	5441732.51	2.58	0	2000	69.9	69.9	0.0	0.0	79.2	24.9	-1.7	0.0	0.0	0.0	0.0	-0.0	-32.5	-32.5
8	500521.70	5441732.51	2.58	0	4000	64.7	64.7	0.0	0.0	79.2	84.4	-1.7	0.0	0.0	0.0	0.0	-0.0	-97.2	-97.2
9	500521.70	5441732.51	2.58	0	8000	55.6	55.6	0.0	0.0	79.2	301.1	-1.7	0.0	0.0	0.0	0.0	-0.0	-322.9	-322.9

Point Source, ISO 9613, Name: "Em_Trans5", ID: "Em_Trans5"																			
Nr.	X	Y	Z	Refl.	Freq.	LxT	LxN	K0	Dc	Adiv	Aatm	Agr	Afol	Ahous	Abar	Cmet	RL	LrT	LrN
	(m)	(m)	(m)		(Hz)	dB(A)	dB(A)	(dB)	(dB)	(dB)	(dB)	(dB)	(dB)	(dB)	(dB)	(dB)	(dB)	dB(A)	dB(A)
1	500755.03	5441956.51	2.58	0	32	37.3	37.3	0.0	0.0	78.1	0.1	-5.7	0.0	0.0	0.0	0.0	-0.0	-35.1	-35.1
2	500755.03	5441956.51	2.58	0	63	56.5	56.5	0.0	0.0	78.1	0.3	-5.7	0.0	0.0	0.0	0.0	-0.0	-16.1	-16.1
3	500755.03	5441956.51	2.58	0	125	68.6	68.6	0.0	0.0	78.1	0.9	4.2	0.0	0.0	0.0	0.0	-0.0	-14.6	-14.6
4	500755.03	5441956.51	2.58	0	250	71.1	71.1	0.0	0.0	78.1	2.3	2.6	0.0	0.0	0.0	0.0	-0.0	-11.9	-11.9
5	500755.03	5441956.51	2.58	0	500	76.5	76.5	0.0	0.0	78.1	4.3	-1.3	0.0	0.0	0.0	0.0	-0.0	-4.6	-4.6
6	500755.03	5441956.51	2.58	0	1000	73.7	73.7	0.0	0.0	78.1	8.2	-1.7	0.0	0.0	0.0	0.0	-0.0	-10.9	-10.9
7	500755.03	5441956.51	2.58	0	2000	69.9	69.9	0.0	0.0	78.1	21.8	-1.7	0.0	0.0	0.0	0.0	-0.0	-28.2	-28.2
8	500755.03	5441956.51	2.58	0	4000	64.7	64.7	0.0	0.0	78.1	73.9	-1.7	0.0	0.0	0.0	0.0	-0.0	-85.5	-85.5
9	500755.03	5441956.51	2.58	0	8000	55.6	55.6	0.0	0.0	78.1	263.4	-1.7	0.0	0.0	0.0	0.0	-0.0	-284.2	-284.2

Point Source, ISO 9613, Name: "Em_Trans6", ID: "Em_Trans6"																			
Nr.	X	Y	Z	Refl.	Freq.	LxT	LxN	K0	Dc	Adiv	Aatm	Agr	Afol	Ahous	Abar	Cmet	RL	LrT	LrN
	(m)	(m)	(m)		(Hz)	dB(A)	dB(A)	(dB)	(dB)	(dB)	(dB)	(dB)	(dB)	(dB)	(dB)	(dB)	(dB)	dB(A)	dB(A)
1	500503.60	5441900.51	2.58	0	32	37.3	37.3	0.0	0.0	78.8	0.1	-5.7	0.0	0.0	0.0	0.0	-0.0	-35.9	-35.9
2	500503.60	5441900.51	2.58	0	63	56.5	56.5	0.0	0.0	78.8	0.3	-5.7	0.0	0.0	0.0	0.0	-0.0	-16.9	-16.9
3	500503.60	5441900.51	2.58	0	125	68.6	68.6	0.0	0.0	78.8	1.0	4.2	0.0	0.0	0.0	0.0	-0.0	-15.4	-15.4
4	500503.60	5441900.51	2.58	0	250	71.1	71.1	0.0	0.0	78.8	2.6	2.6	0.0	0.0	0.0	0.0	-0.0	-12.9	-12.9
5	500503.60	5441900.51	2.58	0	500	76.5	76.5	0.0	0.0	78.8	4.8	-1.3	0.0	0.0	0.0	0.0	-0.0	-5.8	-5.8
6	500503.60	5441900.51	2.58	0	1000	73.7	73.7	0.0	0.0	78.8	9.0	-1.7	0.0	0.0	0.0	0.0	-0.0	-12.4	-12.4
7	500503.60	5441900.51	2.58	0	2000	69.9	69.9	0.0	0.0	78.8	23.8	-1.7	0.0	0.0	0.0	0.0	-0.0	-31.0	-31.0
8	500503.60	5441900.51	2.58	0	4000	64.7	64.7	0.0	0.0	78.8	80.7	-1.7	0.0	0.0	0.0	0.0	-0.0	-93.1	-93.1
9	500503.60	5441900.51	2.58	0	8000	55.6	55.6	0.0	0.0	78.8	287.9	-1.7	0.0	0.0	0.0	0.0	-0.0	-309.4	-309.4

Point Source, ISO 9613, Name: "Em_Trans7", ID: "Em_Trans7"																			
Nr.	X	Y	Z	Refl.	Freq.	LxT	LxN	K0	Dc	Adiv	Aatm	Agr	Afol	Ahous	Abar	Cmet	RL	LrT	LrN
	(m)	(m)	(m)		(Hz)	dB(A)	dB(A)	(dB)	(dB)	(dB)	(dB)	(dB)	(dB)	(dB)	(dB)	(dB)	(dB)	dB(A)	dB(A)
1	500503.60	5442057.31	2.58	0	32	37.3	37.3	0.0	0.0	78.4	0.1	-5.7	0.0	0.0	0.0	0.0	-0.0	-35.5	-35.5
2	500503.60	5442057.31	2.58	0	63	56.5	56.5	0.0	0.0	78.4	0.3	-5.7	0.0	0.0	0.0	0.0	-0.0	-16.5	-16.5
3	500503.60	5442057.31	2.58	0	125	68.6	68.6	0.0	0.0	78.4	1.0	4.2	0.0	0.0	0.0	0.0	-0.0	-15.0	-15.0
4	500503.60	5442057.31	2.58	0	250	71.1	71.1	0.0	0.0	78.4	2.4	2.6	0.0	0.0	0.0	0.0	-0.0	-12.3	-12.3
5	500503.60	5442057.31	2.58	0	500	76.5	76.5	0.0	0.0	78.4	4.5	-1.3	0.0	0.0	0.0	0.0	-0.0	-5.2	-5.2
6	500503.60	5442057.31	2.58	0	1000	73.7	73.7	0.0	0.0	78.4	8.6	-1.7	0.0	0.0	0.0	0.0	-0.0	-11.6	-11.6
7	500503.60	5442057.31	2.58	0	2000	69.9	69.9	0.0	0.0	78.4	22.7	-1.7	0.0	0.0	0.0	0.0	-0.0	-29.5	-29.5
8	500503.60	5442057.31	2.58	0	4000	64.7	64.7	0.0	0.0	78.4	77.1	-1.7	0.0	0.0	0.0	0.0	-0.0	-89.1	-89.1
9	500503.60	5442057.31	2.58	0	8000	55.6	55.6	0.0	0.0	78.4	274.9	-1.7	0.0	0.0	0.0	0.0	-0.0	-296.0	-296.0

Point Source, ISO 9613, Name: "Em_Trans8", ID: "Em_Trans8"																			
Nr.	X	Y	Z	Refl.	Freq.	LxT	LxN	K0	Dc	Adiv	Aatm	Agr	Afol	Ahous	Abar	Cmet	RL	LrT	LrN
	(m)	(m)	(m)		(Hz)	dB(A)	dB(A)	(dB)	(dB)	(dB)	(dB)	(dB)	(dB)	(dB)	(dB)	(dB)	(dB)	dB(A)	dB(A)
1	500467.40	5442281.31	2.58	0	32	37.3	37.3	0.0	0.0	78.0	0.1	-5.7	0.0	0.0	0.0	0.0	-0.0	-35.0	-35.0
2	500467.40	5442281.31	2.58	0	63	56.5	56.5	0.0	0.0	78.0	0.3	-5.7	0.0	0.0	0.0	0.0	-0.0	-16.0	-16.0
3	500467.40	5442281.31	2.58	0	125	68.6	68.6	0.0	0.0	78.0	0.9	4.2	0.0	0.0	0.0	0.0	-0.0	-14.5	-14.5
4	500467.40	5442281.31	2.58	0	250	71.1	71.1	0.0	0.0	78.0	2.3	2.6	0.0	0.0	0.0	0.0	-0.0	-11.8	-11.8
5	500467.40	5442281.31	2.58	0	500	76.5	76.5	0.0	0.0	78.0	4.3	-1.3	0.0	0.0	0.0	0.0	-0.0	-4.5	-4.5
6	500467.40	5442281.31	2.58	0	1000	73.7	73.7	0.0	0.0	78.0	8.2	-1.7	0.0	0.0	0.0	0.0	-0.0	-10.7	-10.7
7	500467.40	5442281.31	2.58	0	2000	69.9	69.9	0.0	0.0	78.0	21.6	-1.7	0.0	0.0	0.0	0.0	-0.0	-27.9	-27.9
8	500467.40	5442281.31	2.58	0	4000	64.7	64.7	0.0	0.0	78.0	73.1	-1.7	0.0	0.0	0.0	0.0	-0.0	-84.6	-84.6
9	500467.40	5442281.31	2.58	0	8000	55.6	55.6	0.0	0.0	78.0	260.7	-1.7	0.0	0.0	0.0	0.0	-0.0	-281.3	-281.3

Point Source, ISO 9613, Name: "Em_Trans9", ID: "Em_Trans9"																			
Nr.	X	Y	Z	Refl.	Freq.	LxT	LxN	K0	Dc	Adiv	Aatm	Agr	Afol	Ahous	Abar	Cmet	RL	LrT	LrN
	(m)	(m)	(m)		(Hz)	dB(A)	dB(A)	(dB)	(dB)	(dB)	(dB)	(dB)	(dB)	(dB)	(dB)	(dB)	(dB)	dB(A)	dB(A)
1	500646.43	5442281.31	2.58	0	32	37.3	37.3	0.0	0.0	77.4	0.1	-5.7	0.0	0.0	0.0	0.0	-0.0	-34.5	-34.5
2	500646.43	5442281.31	2.58	0	63	56.5	56.5	0.0	0.0	77.4	0.3	-5.7	0.0	0.0	0.0	0.0	-0.0	-15.5	-15.5
3	500646.43	5442281.31	2.58	0	125	68.6	68.6	0.0	0.0	77.4	0.9	4.2	0.0	0.0	0.0	0.0	-0.0	-13.9	-13.9
4	500646.43	5442281.31	2.58	0	250	71.1	71.1	0.0	0.0	77.4	2.2	2.6	0.0	0.0	0.0	0.0	-0.0	-11.1	-11.1
5	500646.43	5442281.31	2.58	0	500	76.5	76.5	0.0	0.0	77.4	4.0	-1.3	0.0	0.0	0.0	0.0	-0.0	-3.7	-3.7
6	500646.43	5442281.31	2.58	0	1000	73.7	73.7	0.0	0.0	77.4	7.7	-1.7	0.0	0.0	0.0	0.0	-0.0	-9.7	-9.7
7	500646.43	5442281.31	2.58	0	2000	69.9	69.9	0.0	0.0	77.4	20.2	-1.7	0.0	0.0	0.0	0.0	-0.0	-26.1	-26.1
8	500646.43	5442281.31	2.58	0	4000	64.7	64.7	0.0	0.0	77.4	68.6	-1.7	0.0	0.0	0.0	0.0	-0.0	-79.6	-79.6
9	500646.43	5442281.31	2.58	0	8000	55.6	55.6	0.0	0.0	77.4	244.8	-1.7	0.0	0.0	0.0	0.0	-0.0	-264.9	-264.9

Point Source, ISO 9613, Name: "Em_Trans10", ID: "Em_Trans10"																			
Nr.	X	Y	Z	Refl.	Freq.	LxT	LxN	K0	Dc	Adiv	Aatm	Agr	Afol	Ahous	Abar	Cmet	RL	LrT	LrN
	(m)	(m)	(m)		(Hz)	dB(A)	dB(A)	(dB)	(dB)	(dB)	(dB)	(dB)	(dB)	(dB)	(dB)	(dB)	(dB)	dB(A)	dB(A)
1	499998.21	5441665.31	2.58	0	32	37.3	37.3	0.0	0.0	80.5	0.1	-5.8	0.0	0.0	0.0	0.0	-0.0	-37.5	-37.5
2	499998.21	5441665.31	2.58	0	63	56.5	56.5	0.0	0.0	80.5	0.4	-5.8	0.0	0.0	0.0	0.0	-0.0	-18.6	-18.6
3	499998.21	5441665.31	2.58	0	125	68.6	68.6	0.0	0.0	80.5	1.2	4.2	0.0	0.0	0.0	0.0	-0.0	-17.3	-17.3
4	499998.21	5441665.31	2.58	0	250	71.1	71.1	0.0	0.0	80.5	3.1	2.5	0.0	0.0	0.0	0.0	-0.0	-15.1	-15.1
5	499998.21	5441665.31	2.58	0	500	76.5	76.5	0.0	0.0	80.5	5.8	-1.3	0.0	0.0	0.0	0.0	-0.0	-8.5	-8.5
6	499998.21	5441665.31	2.58	0	1000	73.7	73.7	0.0	0.0	80.5	10.9	-1.7	0.0	0.0	0.0	0.0	-0.0	-16.0	-16.0
7	499998.21	5441665.31	2.58	0	2000	69.9	69.9	0.0	0.0	80.5	28.9	-1.7	0.0	0.0	0.0	0.0	-0.0	-37.8	-37.8
8	499998.21	5441665.31	2.58	0	4000	64.7	64.7	0.0	0.0	80.5	97.9	-1.7	0.0	0.0	0.0	0.0	-0.0	-112.0	-112.0
9	499998.21	5441665.31	2.58	0	8000	55.6	55.6	0.0	0.0	80.5	349.3	-1.7	0.0	0.0	0.0	0.0	-0.0	-372.4	-372.4

Point Source, ISO 9613, Name: "MM_Sub115", ID: "MM_Sub115"																			
Nr.	X	Y	Z	Refl.	Freq.	LxT	LxN	K0	Dc	Adiv	Aatm	Agr	Afol	Ahous	Abar	Cmet	RL	LrT	LrN
	(m)	(m)	(m)		(Hz)	dB(A)	dB(A)	(dB)	(dB)	(dB)	(dB)	(dB)	(dB)	(dB)	(dB)	(dB)	(dB)	dB(A)	dB(A)
1	500993.61	5443521.27	3.60	0	32	43.3	43.3	0.0	0.0	72.7	0.0	-5.4	0.0	0.0	0.0	0.0	-0.0	-24.0	-24.0
2	500993.61	5443521.27	3.60	0	63	60.5	60.5	0.0	0.0	72.7	0.2	-5.4	0.0	0.0	0.0	0.0	-0.0	-6.9	-6.9
3	500993.61	5443521.27	3.60	0	125	73.6	73.6	0.0	0.0	72.7	0.5	3.9	0.0	0.0	0.0	0.0	-0.0	-3.5	-3.5
4	500993.61	5443521.27	3.60	0	250	79.1	79.1	0.0	0.0	72.7	1.3	1.2	0.0	0.0	0.0	0.0	-0.0	3.9	3.9
5	500993.61	5443521.27	3.60	0	500	84.5	84.5	0.0	0.0	72.7	2.3	-1.6	0.0	0.0	0.0	0.0	-0.0	11.1	11.1
6	500993.61	5443521.27	3.60	0	1000	81.7	81.7	0.0	0.0	72.7	4.4	-1.6	0.0	0.0	0.0	0.0	-0.0	6.2	6.2
7	500993.61	5443521.27	3.60	0	2000	77.9	77.9	0.0	0.0	72.7	11.7	-1.6	0.0	0.0	0.0	0.0	-0.0	-4.9	-4.9
8	500993.61	5443521.27	3.60	0	4000	72.7	72.7	0.0	0.0	72.7	39.8	-1.6	0.0	0.0	0.0	0.0	-0.0	-38.2	-38.2
9	500993.61	5443521.27	3.60	0	8000	62.6	62.6	0.0	0.0	72.7	142.0	-1.6	0.0	0.0	0.0	0.0	-0.0	-150.5	-150.5

Point Source, ISO 9613, Name: "MM_Inv1", ID: "MM_Inv1"																			
Nr.	X	Y	Z	Refl.	Freq.	LxT	LxN	K0	Dc	Adiv	Aatm	Agr	Afol	Ahous	Abar	Cmet	RL	LrT	LrN
	(m)	(m)	(m)		(Hz)	dB(A)	dB(A)	(dB)	(dB)	(dB)	(dB)	(dB)	(dB)	(dB)	(dB)	(dB)	(dB)	dB(A)	dB(A)
1	501222.00	5443157.66	2.60	0	63	68.1	68.1	0.0	0.0	71.9	0.1	-5.4	0.0	0.0	0.0	0.0	-0.0	1.5	1.5
2	501222.00	5443157.66	2.60	0	125	78.9	78.9	0.0	0.0	71.9	0.5	4.2	0.0	0.0	0.0	0.0	-0.0	2.3	2.3
3	501222.00	5443157.66	2.60	0	250	85.5	85.5	0.0	0.0	71.9	1.2	2.6	0.0	0.0	0.0	0.0	-0.0	9.8	9.8
4	501222.00	5443157.66	2.60	0	500	87.3	87.3	0.0	0.0	71.9	2.1	-1.2	0.0	0.0	0.0	0.0	-0.0	14.4	14.4
5	501222.00	5443157.66	2.60	0	1000	83.7	83.7	0.0	0.0	71.9	4.1	-1.6	0.0	0.0	0.0	0.0	-0.0	9.4	9.4
6	501222.00	5443157.66	2.60	0	2000	79.1	79.1	0.0	0.0	71.9	10.7	-1.6	0.0	0.0	0.0	0.0	-0.0	-1.9	-1.9
7	501222.00	5443157.66	2.60	0	4000	70.0	70.0	0.0	0.0	71.9	36.4	-1.6	0.0	0.0	0.0	0.0	-0.0	-36.7	-36.7
8	501222.00	5443157.66	2.60	0	8000	77.7	77.7	0.0	0.0	71.9	129.8	-1.6	0.0	0.0	0.0	0.0	-0.0	-122.4	-122.4

Point Source, ISO 9613, Name: "MM_Inv2", ID: "MM_Inv2"																			
Nr.	X	Y	Z	Refl.	Freq.	LxT	LxN	K0	Dc	Adiv	Aatm	Agr	Afol	Ahous	Abar	Cmet	RL	LrT	LrN
	(m)	(m)	(m)		(Hz)	dB(A)	dB(A)	(dB)	(dB)	(dB)	(dB)	(dB)	(dB)	(dB)	(dB)	(dB)	(dB)	dB(A)	dB(A)
1	501240.10	5442978.46	2.60	0	63	68.1	68.1	0.0	0.0	72.5	0.2	-5.5	0.0	0.0	0.0	0.0	-0.0	0.9	0.9
2	501240.10	5442978.46	2.60	0	125	78.9	78.9	0.0	0.0	72.5	0.5	4.2	0.0	0.0	0.0	0.0	-0.0	1.7	1.7
3	501240.10	5442978.46	2.60	0	250	85.5	85.5	0.0	0.0	72.5	1.2	2.6	0.0	0.0	0.0	0.0	-0.0	9.1	9.1
4	501240.10	5442978.46	2.60	0	500	87.3	87.3	0.0	0.0	72.5	2.3	-1.2	0.0	0.0	0.0	0.0	-0.0	13.7	13.7
5	501240.10	5442978.46	2.60	0	1000	83.7	83.7	0.0	0.0	72.5	4.4	-1.6	0.0	0.0	0.0	0.0	-0.0	8.5	8.5
6	501240.10	5442978.46	2.60	0	2000	79.1	79.1	0.0	0.0	72.5	11.5	-1.6	0.0	0.0	0.0	0.0	-0.0	-3.3	-3.3
7	501240.10	5442978.46	2.60	0	4000	70.0	70.0	0.0	0.0	72.5	39.1	-1.6	0.0	0.0	0.0	0.0	-0.0	-39.9	-39.9
8	501240.10	5442978.46	2.60	0	8000	77.7	77.7	0.0	0.0	72.5	139.3	-1.6	0.0	0.0	0.0	0.0	-0.0	-132.5	-132.5

Point Source, ISO 9613, Name: "MM_Inv3", ID: "MM_Inv3"																			
Nr.	X	Y	Z	Refl.	Freq.	LxT	LxN	K0	Dc	Adiv	Aatm	Agr	Afol	Ahous	Abar	Cmet	RL	LrT	LrN
	(m)	(m)	(m)		(Hz)	dB(A)	dB(A)	(dB)	(dB)	(dB)	(dB)	(dB)	(dB)	(dB)	(dB)	(dB)	(dB)	dB(A)	dB(A)
1	501240.10	5442776.86	2.60	0	63	68.1	68.1	0.0	0.0	73.4	0.2	-5.5	0.0	0.0	0.0	0.0	-0.0	0.0	0.0
2	501240.10	5442776.86	2.60	0	125	78.9	78.9	0.0	0.0	73.4	0.5	4.2	0.0	0.0	0.0	0.0	-0.0	0.7	0.7
3	501240.10	5442776.86	2.60	0	250	85.5	85.5	0.0	0.0	73.4	1.4	2.6	0.0	0.0	0.0	0.0	-0.0	8.1	8.1
4	501240.10	5442776.86	2.60	0	500	87.3	87.3	0.0	0.0	73.4	2.5	-1.2	0.0	0.0	0.0	0.0	-0.0	12.5	12.5
5	501240.10	5442776.86	2.60	0	1000	83.7	83.7	0.0	0.0	73.4	4.8	-1.7	0.0	0.0	0.0	0.0	-0.0	7.1	7.1
6	501240.10	5442776.86	2.60	0	2000	79.1	79.1	0.0	0.0	73.4	12.8	-1.7	0.0	0.0	0.0	0.0	-0.0	-5.4	-5.4
7	501240.10	5442776.86	2.60	0	4000	70.0	70.0	0.0	0.0	73.4	43.3	-1.7	0.0	0.0	0.0	0.0	-0.0	-45.1	-45.1
8	501240.10	5442776.86	2.60	0	8000	77.7	77.7	0.0	0.0	73.4	154.5	-1.7	0.0	0.0	0.0	0.0	-0.0	-148.6	-148.6

Point Source, ISO 9613, Name: "MM_Inv4", ID: "MM_Inv4"																			
Nr.	X	Y	Z	Refl.	Freq.	LxT	LxN	K0	Dc	Adiv	Aatm	Agr	Afol	Ahous	Abar	Cmet	RL	LrT	LrN
	(m)	(m)	(m)		(Hz)	dB(A)	dB(A)	(dB)	(dB)	(dB)	(dB)	(dB)	(dB)	(dB)	(dB)	(dB)	(dB)	dB(A)	dB(A)
1	501240.10	5442575.26	2.60	0	63	68.1	68.1	0.0	0.0	74.3	0.2	-5.6	0.0	0.0	0.0	0.0	-0.0	-0.9	-0.9

Point Source, ISO 9613, Name: "MM_Inv4", ID: "MM_Inv4"																			
Nr.	X	Y	Z	Refl.	Freq.	LxT	LxN	K0	Dc	Adiv	Aatm	Agr	Afol	Ahous	Abar	Cmet	RL	LrT	LrN
	(m)	(m)	(m)		(Hz)	dB(A)	dB(A)	(dB)	(dB)	(dB)	(dB)	(dB)	(dB)	(dB)	(dB)	(dB)	(dB)	dB(A)	dB(A)
2	501240.10	5442575.26	2.60	0	125	78.9	78.9	0.0	0.0	74.3	0.6	4.2	0.0	0.0	0.0	0.0	-0.0	-0.3	-0.3
3	501240.10	5442575.26	2.60	0	250	85.5	85.5	0.0	0.0	74.3	1.5	2.6	0.0	0.0	0.0	0.0	-0.0	7.0	7.0
4	501240.10	5442575.26	2.60	0	500	87.3	87.3	0.0	0.0	74.3	2.8	-1.2	0.0	0.0	0.0	0.0	-0.0	11.4	11.4
5	501240.10	5442575.26	2.60	0	1000	83.7	83.7	0.0	0.0	74.3	5.4	-1.7	0.0	0.0	0.0	0.0	-0.0	5.6	5.6
6	501240.10	5442575.26	2.60	0	2000	79.1	79.1	0.0	0.0	74.3	14.2	-1.7	0.0	0.0	0.0	0.0	-0.0	-7.8	-7.8
7	501240.10	5442575.26	2.60	0	4000	70.0	70.0	0.0	0.0	74.3	48.1	-1.7	0.0	0.0	0.0	0.0	-0.0	-50.8	-50.8
8	501240.10	5442575.26	2.60	0	8000	77.7	77.7	0.0	0.0	74.3	171.6	-1.7	0.0	0.0	0.0	0.0	-0.0	-166.6	-166.6

Point Source, ISO 9613, Name: "MM_Inv5", ID: "MM_Inv5"																			
Nr.	X	Y	Z	Refl.	Freq.	LxT	LxN	K0	Dc	Adiv	Aatm	Agr	Afol	Ahous	Abar	Cmet	RL	LrT	LrN
	(m)	(m)	(m)		(Hz)	dB(A)	dB(A)	(dB)	(dB)	(dB)	(dB)	(dB)	(dB)	(dB)	(dB)	(dB)	(dB)	dB(A)	dB(A)
1	500977.67	5442553.91	2.60	0	63	68.1	68.1	0.0	0.0	75.4	0.2	-5.6	0.0	0.0	0.0	0.0	-0.0	-1.9	-1.9
2	500977.67	5442553.91	2.60	0	125	78.9	78.9	0.0	0.0	75.4	0.7	4.2	0.0	0.0	0.0	0.0	-0.0	-1.4	-1.4
3	500977.67	5442553.91	2.60	0	250	85.5	85.5	0.0	0.0	75.4	1.7	2.6	0.0	0.0	0.0	0.0	-0.0	5.8	5.8
4	500977.67	5442553.91	2.60	0	500	87.3	87.3	0.0	0.0	75.4	3.2	-1.3	0.0	0.0	0.0	0.0	-0.0	9.9	9.9
5	500977.67	5442553.91	2.60	0	1000	83.7	83.7	0.0	0.0	75.4	6.1	-1.7	0.0	0.0	0.0	0.0	-0.0	3.8	3.8
6	500977.67	5442553.91	2.60	0	2000	79.1	79.1	0.0	0.0	75.4	16.1	-1.7	0.0	0.0	0.0	0.0	-0.0	-10.8	-10.8
7	500977.67	5442553.91	2.60	0	4000	70.0	70.0	0.0	0.0	75.4	54.6	-1.7	0.0	0.0	0.0	0.0	-0.0	-58.3	-58.3
8	500977.67	5442553.91	2.60	0	8000	77.7	77.7	0.0	0.0	75.4	194.7	-1.7	0.0	0.0	0.0	0.0	-0.0	-190.8	-190.8

Point Source, ISO 9613, Name: "MM_Inv6", ID: "MM_Inv6"																			
Nr.	X	Y	Z	Refl.	Freq.	LxT	LxN	K0	Dc	Adiv	Aatm	Agr	Afol	Ahous	Abar	Cmet	RL	LrT	LrN
	(m)	(m)	(m)		(Hz)	dB(A)	dB(A)	(dB)	(dB)	(dB)	(dB)	(dB)	(dB)	(dB)	(dB)	(dB)	(dB)	dB(A)	dB(A)
1	500977.67	5442755.51	2.60	0	63	68.1	68.1	0.0	0.0	74.7	0.2	-5.6	0.0	0.0	0.0	0.0	-0.0	-1.2	-1.2
2	500977.67	5442755.51	2.60	0	125	78.9	78.9	0.0	0.0	74.7	0.6	4.2	0.0	0.0	0.0	0.0	-0.0	-0.7	-0.7
3	500977.67	5442755.51	2.60	0	250	85.5	85.5	0.0	0.0	74.7	1.6	2.6	0.0	0.0	0.0	0.0	-0.0	6.6	6.6
4	500977.67	5442755.51	2.60	0	500	87.3	87.3	0.0	0.0	74.7	3.0	-1.2	0.0	0.0	0.0	0.0	-0.0	10.9	10.9
5	500977.67	5442755.51	2.60	0	1000	83.7	83.7	0.0	0.0	74.7	5.6	-1.7	0.0	0.0	0.0	0.0	-0.0	5.0	5.0
6	500977.67	5442755.51	2.60	0	2000	79.1	79.1	0.0	0.0	74.7	14.8	-1.7	0.0	0.0	0.0	0.0	-0.0	-8.8	-8.8
7	500977.67	5442755.51	2.60	0	4000	70.0	70.0	0.0	0.0	74.7	50.3	-1.7	0.0	0.0	0.0	0.0	-0.0	-53.4	-53.4
8	500977.67	5442755.51	2.60	0	8000	77.7	77.7	0.0	0.0	74.7	179.5	-1.7	0.0	0.0	0.0	0.0	-0.0	-174.8	-174.8

Point Source, ISO 9613, Name: "MM_Inv7", ID: "MM_Inv7"																			
Nr.	X	Y	Z	Refl.	Freq.	LxT	LxN	K0	Dc	Adiv	Aatm	Agr	Afol	Ahous	Abar	Cmet	RL	LrT	LrN
	(m)	(m)	(m)		(Hz)	dB(A)	dB(A)	(dB)	(dB)	(dB)	(dB)	(dB)	(dB)	(dB)	(dB)	(dB)	(dB)	dB(A)	dB(A)
1	500977.67	5442957.06	2.60	0	63	68.1	68.1	0.0	0.0	74.1	0.2	-5.5	0.0	0.0	0.0	0.0	-0.0	-0.6	-0.6
2	500977.67	5442957.06	2.60	0	125	78.9	78.9	0.0	0.0	74.1	0.6	4.2	0.0	0.0	0.0	0.0	-0.0	0.0	0.0
3	500977.67	5442957.06	2.60	0	250	85.5	85.5	0.0	0.0	74.1	1.5	2.6	0.0	0.0	0.0	0.0	-0.0	7.4	7.4
4	500977.67	5442957.06	2.60	0	500	87.3	87.3	0.0	0.0	74.1	2.7	-1.2	0.0	0.0	0.0	0.0	-0.0	11.7	11.7
5	500977.67	5442957.06	2.60	0	1000	83.7	83.7	0.0	0.0	74.1	5.2	-1.7	0.0	0.0	0.0	0.0	-0.0	6.1	6.1
6	500977.67	5442957.06	2.60	0	2000	79.1	79.1	0.0	0.0	74.1	13.7	-1.7	0.0	0.0	0.0	0.0	-0.0	-7.0	-7.0
7	500977.67	5442957.06	2.60	0	4000	70.0	70.0	0.0	0.0	74.1	46.6	-1.7	0.0	0.0	0.0	0.0	-0.0	-49.0	-49.0
8	500977.67	5442957.06	2.60	0	8000	77.7	77.7	0.0	0.0	74.1	166.2	-1.7	0.0	0.0	0.0	0.0	-0.0	-160.9	-160.9

Point Source, ISO 9613, Name: "MM_Trans1", ID: "MM_Trans1"																			
Nr.	X	Y	Z	Refl.	Freq.	LxT	LxN	K0	Dc	Adiv	Aatm	Agr	Afol	Ahous	Abar	Cmet	RL	LrT	LrN
	(m)	(m)	(m)		(Hz)	dB(A)	dB(A)	(dB)	(dB)	(dB)	(dB)	(dB)	(dB)	(dB)	(dB)	(dB)	(dB)	dB(A)	dB(A)
1	501216.50	5443158.16	2.58	0	32	37.3	37.3	0.0	0.0	72.0	0.0	-5.4	0.0	0.0	0.0	0.0	-0.0	-29.3	-29.3
2	501216.50	5443158.16	2.58	0	63	56.5	56.5	0.0	0.0	72.0	0.1	-5.4	0.0	0.0	0.0	0.0	-0.0	-10.2	-10.2
3	501216.50	5443158.16	2.58	0	125	68.6	68.6	0.0	0.0	72.0	0.5	4.2	0.0	0.0	0.0	0.0	-0.0	-8.0	-8.0
4	501216.50	5443158.16	2.58	0	250	71.1	71.1	0.0	0.0	72.0	1.2	2.6	0.0	0.0	0.0	0.0	-0.0	-4.7	-4.7
5	501216.50	5443158.16	2.58	0	500	76.5	76.5	0.0	0.0	72.0	2.1	-1.2	0.0	0.0	0.0	0.0	-0.0	3.6	3.6
6	501216.50	5443158.16	2.58	0	1000	73.7	73.7	0.0	0.0	72.0	4.1	-1.6	0.0	0.0	0.0	0.0	-0.0	-0.7	-0.7
7	501216.50	5443158.16	2.58	0	2000	69.9	69.9	0.0	0.0	72.0	10.8	-1.6	0.0	0.0	0.0	0.0	-0.0	-11.2	-11.2
8	501216.50	5443158.16	2.58	0	4000	64.7	64.7	0.0	0.0	72.0	36.5	-1.6	0.0	0.0	0.0	0.0	-0.0	-42.1	-42.1
9	501216.50	5443158.16	2.58	0	8000	55.6	55.6	0.0	0.0	72.0	130.3	-1.6	0.0	0.0	0.0	0.0	-0.0	-145.0	-145.0

Point Source, ISO 9613, Name: "MM_Trans2", ID: "MM_Trans2"																			
Nr.	X	Y	Z	Refl.	Freq.	LxT	LxN	K0	Dc	Adiv	Aatm	Agr	Afol	Ahous	Abar	Cmet	RL	LrT	LrN
	(m)	(m)	(m)		(Hz)	dB(A)	dB(A)	(dB)	(dB)	(dB)	(dB)	(dB)	(dB)	(dB)	(dB)	(dB)	(dB)	dB(A)	dB(A)
1	501234.60	5442978.96	2.58	0	32	37.3	37.3	0.0	0.0	72.5	0.0	-5.5	0.0	0.0	0.0	0.0	-0.0	-29.8	-29.8
2	501234.60	5442978.96	2.58	0	63	56.5	56.5	0.0	0.0	72.5	0.2	-5.5	0.0	0.0	0.0	0.0	-0.0	-10.7	-10.7
3	501234.60	5442978.96	2.58	0	125	68.6	68.6	0.0	0.0	72.5	0.5	4.2	0.0	0.0	0.0	0.0	-0.0	-8.7	-8.7

Point Source, ISO 9613, Name: "MM_Trans2", ID: "MM_Trans2"																			
Nr.	X	Y	Z	Refl.	Freq.	LxT	LxN	K0	Dc	Adiv	Aatm	Agr	Afol	Ahous	Abar	Cmet	RL	LrT	LrN
	(m)	(m)	(m)		(Hz)	dB(A)	dB(A)	(dB)	(dB)	(dB)	(dB)	(dB)	(dB)	(dB)	(dB)	(dB)	(dB)	dB(A)	dB(A)
4	501234.60	5442978.96	2.58	0	250	71.1	71.1	0.0	0.0	72.5	1.3	2.6	0.0	0.0	0.0	0.0	-0.0	-5.3	-5.3
5	501234.60	5442978.96	2.58	0	500	76.5	76.5	0.0	0.0	72.5	2.3	-1.2	0.0	0.0	0.0	0.0	-0.0	2.8	2.8
6	501234.60	5442978.96	2.58	0	1000	73.7	73.7	0.0	0.0	72.5	4.4	-1.6	0.0	0.0	0.0	0.0	-0.0	-1.6	-1.6
7	501234.60	5442978.96	2.58	0	2000	69.9	69.9	0.0	0.0	72.5	11.6	-1.6	0.0	0.0	0.0	0.0	-0.0	-12.6	-12.6
8	501234.60	5442978.96	2.58	0	4000	64.7	64.7	0.0	0.0	72.5	39.2	-1.6	0.0	0.0	0.0	0.0	-0.0	-45.4	-45.4
9	501234.60	5442978.96	2.58	0	8000	55.6	55.6	0.0	0.0	72.5	139.8	-1.6	0.0	0.0	0.0	0.0	-0.0	-155.1	-155.1

Point Source, ISO 9613, Name: "MM_Trans3", ID: "MM_Trans3"																			
Nr.	X	Y	Z	Refl.	Freq.	LxT	LxN	K0	Dc	Adiv	Aatm	Agr	Afol	Ahous	Abar	Cmet	RL	LrT	LrN
	(m)	(m)	(m)		(Hz)	dB(A)	dB(A)	(dB)	(dB)	(dB)	(dB)	(dB)	(dB)	(dB)	(dB)	(dB)	(dB)	dB(A)	dB(A)
1	501234.60	5442777.36	2.58	0	32	37.3	37.3	0.0	0.0	73.5	0.0	-5.5	0.0	0.0	0.0	0.0	-0.0	-30.7	-30.7
2	501234.60	5442777.36	2.58	0	63	56.5	56.5	0.0	0.0	73.5	0.2	-5.5	0.0	0.0	0.0	0.0	-0.0	-11.6	-11.6
3	501234.60	5442777.36	2.58	0	125	68.6	68.6	0.0	0.0	73.5	0.5	4.2	0.0	0.0	0.0	0.0	-0.0	-9.6	-9.6
4	501234.60	5442777.36	2.58	0	250	71.1	71.1	0.0	0.0	73.5	1.4	2.6	0.0	0.0	0.0	0.0	-0.0	-6.4	-6.4
5	501234.60	5442777.36	2.58	0	500	76.5	76.5	0.0	0.0	73.5	2.6	-1.2	0.0	0.0	0.0	0.0	-0.0	1.7	1.7
6	501234.60	5442777.36	2.58	0	1000	73.7	73.7	0.0	0.0	73.5	4.8	-1.7	0.0	0.0	0.0	0.0	-0.0	-2.9	-2.9
7	501234.60	5442777.36	2.58	0	2000	69.9	69.9	0.0	0.0	73.5	12.8	-1.7	0.0	0.0	0.0	0.0	-0.0	-14.7	-14.7
8	501234.60	5442777.36	2.58	0	4000	64.7	64.7	0.0	0.0	73.5	43.4	-1.7	0.0	0.0	0.0	0.0	-0.0	-50.5	-50.5
9	501234.60	5442777.36	2.58	0	8000	55.6	55.6	0.0	0.0	73.5	154.9	-1.7	0.0	0.0	0.0	0.0	-0.0	-171.1	-171.1

Point Source, ISO 9613, Name: "MM_Trans4", ID: "MM_Trans4"																			
Nr.	X	Y	Z	Refl.	Freq.	LxT	LxN	K0	Dc	Adiv	Aatm	Agr	Afol	Ahous	Abar	Cmet	RL	LrT	LrN
	(m)	(m)	(m)		(Hz)	dB(A)	dB(A)	(dB)	(dB)	(dB)	(dB)	(dB)	(dB)	(dB)	(dB)	(dB)	(dB)	dB(A)	dB(A)
1	501234.60	5442575.76	2.58	0	32	37.3	37.3	0.0	0.0	74.4	0.1	-5.6	0.0	0.0	0.0	0.0	-0.0	-31.5	-31.5
2	501234.60	5442575.76	2.58	0	63	56.5	56.5	0.0	0.0	74.4	0.2	-5.6	0.0	0.0	0.0	0.0	-0.0	-12.5	-12.5
3	501234.60	5442575.76	2.58	0	125	68.6	68.6	0.0	0.0	74.4	0.6	4.2	0.0	0.0	0.0	0.0	-0.0	-10.6	-10.6
4	501234.60	5442575.76	2.58	0	250	71.1	71.1	0.0	0.0	74.4	1.5	2.6	0.0	0.0	0.0	0.0	-0.0	-7.4	-7.4
5	501234.60	5442575.76	2.58	0	500	76.5	76.5	0.0	0.0	74.4	2.8	-1.2	0.0	0.0	0.0	0.0	-0.0	0.5	0.5
6	501234.60	5442575.76	2.58	0	1000	73.7	73.7	0.0	0.0	74.4	5.4	-1.7	0.0	0.0	0.0	0.0	-0.0	-4.4	-4.4
7	501234.60	5442575.76	2.58	0	2000	69.9	69.9	0.0	0.0	74.4	14.2	-1.7	0.0	0.0	0.0	0.0	-0.0	-17.0	-17.0
8	501234.60	5442575.76	2.58	0	4000	64.7	64.7	0.0	0.0	74.4	48.2	-1.7	0.0	0.0	0.0	0.0	-0.0	-56.2	-56.2
9	501234.60	5442575.76	2.58	0	8000	55.6	55.6	0.0	0.0	74.4	172.0	-1.7	0.0	0.0	0.0	0.0	-0.0	-189.1	-189.1

Point Source, ISO 9613, Name: "MM_Trans5", ID: "MM_Trans5"																			
Nr.	X	Y	Z	Refl.	Freq.	LxT	LxN	K0	Dc	Adiv	Aatm	Agr	Afol	Ahous	Abar	Cmet	RL	LrT	LrN
	(m)	(m)	(m)		(Hz)	dB(A)	dB(A)	(dB)	(dB)	(dB)	(dB)	(dB)	(dB)	(dB)	(dB)	(dB)	(dB)	dB(A)	dB(A)
1	500983.17	5442553.41	2.58	0	32	37.3	37.3	0.0	0.0	75.4	0.1	-5.6	0.0	0.0	0.0	0.0	-0.0	-32.5	-32.5
2	500983.17	5442553.41	2.58	0	63	56.5	56.5	0.0	0.0	75.4	0.2	-5.6	0.0	0.0	0.0	0.0	-0.0	-13.5	-13.5
3	500983.17	5442553.41	2.58	0	125	68.6	68.6	0.0	0.0	75.4	0.7	4.2	0.0	0.0	0.0	0.0	-0.0	-11.7	-11.7
4	500983.17	5442553.41	2.58	0	250	71.1	71.1	0.0	0.0	75.4	1.7	2.6	0.0	0.0	0.0	0.0	-0.0	-8.6	-8.6
5	500983.17	5442553.41	2.58	0	500	76.5	76.5	0.0	0.0	75.4	3.2	-1.2	0.0	0.0	0.0	0.0	-0.0	-0.9	-0.9
6	500983.17	5442553.41	2.58	0	1000	73.7	73.7	0.0	0.0	75.4	6.1	-1.7	0.0	0.0	0.0	0.0	-0.0	-6.1	-6.1
7	500983.17	5442553.41	2.58	0	2000	69.9	69.9	0.0	0.0	75.4	16.1	-1.7	0.0	0.0	0.0	0.0	-0.0	-19.9	-19.9
8	500983.17	5442553.41	2.58	0	4000	64.7	64.7	0.0	0.0	75.4	54.5	-1.7	0.0	0.0	0.0	0.0	-0.0	-63.5	-63.5
9	500983.17	5442553.41	2.58	0	8000	55.6	55.6	0.0	0.0	75.4	194.3	-1.7	0.0	0.0	0.0	0.0	-0.0	-212.4	-212.4

Point Source, ISO 9613, Name: "MM_Trans6", ID: "MM_Trans6"																			
Nr.	X	Y	Z	Refl.	Freq.	LxT	LxN	K0	Dc	Adiv	Aatm	Agr	Afol	Ahous	Abar	Cmet	RL	LrT	LrN
	(m)	(m)	(m)		(Hz)	dB(A)	dB(A)	(dB)	(dB)	(dB)	(dB)	(dB)	(dB)	(dB)	(dB)	(dB)	(dB)	dB(A)	dB(A)
1	500983.17	5442755.01	2.58	0	32	37.3	37.3	0.0	0.0	74.7	0.1	-5.6	0.0	0.0	0.0	0.0	-0.0	-31.9	-31.9
2	500983.17	5442755.01	2.58	0	63	56.5	56.5	0.0	0.0	74.7	0.2	-5.6	0.0	0.0	0.0	0.0	-0.0	-12.8	-12.8
3	500983.17	5442755.01	2.58	0	125	68.6	68.6	0.0	0.0	74.7	0.6	4.2	0.0	0.0	0.0	0.0	-0.0	-11.0	-11.0
4	500983.17	5442755.01	2.58	0	250	71.1	71.1	0.0	0.0	74.7	1.6	2.6	0.0	0.0	0.0	0.0	-0.0	-7.8	-7.8
5	500983.17	5442755.01	2.58	0	500	76.5	76.5	0.0	0.0	74.7	2.9	-1.2	0.0	0.0	0.0	0.0	-0.0	0.1	0.1
6	500983.17	5442755.01	2.58	0	1000	73.7	73.7	0.0	0.0	74.7	5.6	-1.7	0.0	0.0	0.0	0.0	-0.0	-4.9	-4.9
7	500983.17	5442755.01	2.58	0	2000	69.9	69.9	0.0	0.0	74.7	14.8	-1.7	0.0	0.0	0.0	0.0	-0.0	-17.9	-17.9
8	500983.17	5442755.01	2.58	0	4000	64.7	64.7	0.0	0.0	74.7	50.2	-1.7	0.0	0.0	0.0	0.0	-0.0	-58.5	-58.5
9	500983.17	5442755.01	2.58	0	8000	55.6	55.6	0.0	0.0	74.7	179.0	-1.7	0.0	0.0	0.0	0.0	-0.0	-196.4	-196.4

Point Source, ISO 9613, Name: "MM_Trans7", ID: "MM_Trans7"																			
Nr.	X	Y	Z	Refl.	Freq.	LxT	LxN	K0	Dc	Adiv	Aatm	Agr	Afol	Ahous	Abar	Cmet	RL	LrT	LrN
	(m)	(m)	(m)		(Hz)	dB(A)	dB(A)	(dB)	(dB)	(dB)	(dB)	(dB)	(dB)	(dB)	(dB)	(dB)	(dB)	dB(A)	dB(A)
1	500983.17	5442956.56	2.58	0	32	37.3	37.3	0.0	0.0	74.0	0.1	-5.5	0.0	0.0	0.0	0.0	-0.0	-31.2	-31.2

Point Source, ISO 9613, Name: "MM_Trans7", ID: "MM_Trans7"																			
Nr.	X	Y	Z	Refl.	Freq.	LxT	LxN	K0	Dc	Adiv	Aatm	Agr	Afol	Ahous	Abar	Cmet	RL	LrT	LrN
	(m)	(m)	(m)		(Hz)	dB(A)	dB(A)	(dB)	(dB)	(dB)	(dB)	(dB)	(dB)	(dB)	(dB)	(dB)	(dB)	dB(A)	dB(A)
2	500983.17	5442956.56	2.58	0	63	56.5	56.5	0.0	0.0	74.0	0.2	-5.5	0.0	0.0	0.0	0.0	-0.0	-12.2	-12.2
3	500983.17	5442956.56	2.58	0	125	68.6	68.6	0.0	0.0	74.0	0.6	4.2	0.0	0.0	0.0	0.0	-0.0	-10.3	-10.3
4	500983.17	5442956.56	2.58	0	250	71.1	71.1	0.0	0.0	74.0	1.5	2.6	0.0	0.0	0.0	0.0	-0.0	-7.0	-7.0
5	500983.17	5442956.56	2.58	0	500	76.5	76.5	0.0	0.0	74.0	2.7	-1.2	0.0	0.0	0.0	0.0	-0.0	0.9	0.9
6	500983.17	5442956.56	2.58	0	1000	73.7	73.7	0.0	0.0	74.0	5.2	-1.7	0.0	0.0	0.0	0.0	-0.0	-3.9	-3.9
7	500983.17	5442956.56	2.58	0	2000	69.9	69.9	0.0	0.0	74.0	13.7	-1.7	0.0	0.0	0.0	0.0	-0.0	-16.2	-16.2
8	500983.17	5442956.56	2.58	0	4000	64.7	64.7	0.0	0.0	74.0	46.5	-1.7	0.0	0.0	0.0	0.0	-0.0	-54.1	-54.1
9	500983.17	5442956.56	2.58	0	8000	55.6	55.6	0.0	0.0	74.0	165.7	-1.7	0.0	0.0	0.0	0.0	-0.0	-182.5	-182.5

